



Sistema

ATi

Sistema ATi

Sistema de batente com RPT - 55 mm

Características do sistema

Sistema de batente com rotura térmica e de elevadas prestações térmicas e acústicas.

O sistema ATi possibilita a execução de 4 versões de caixilharia:

1. linha recta;
2. linha curva;
3. linha tradição;
4. linha oval.

O sistema ATi permite a aplicação de vidros duplos de alto rendimento de modo a responder às exigências de isolamento térmico e acústico.

Perfis de alumínio

Os perfis de alumínio são extrudidos na liga de alumínio 6060 para arquitectura de acordo com norma NP EN 12020-02.

Perfis com rotura térmica obtida por inserção de varetas isolantes de poliamida tipo ómega de 24 mm reforçadas com 25% de fibra de vidro.

Espessura média dos perfis de alumínio de 1.5 mm para janelas e de 1.7 mm para portas;

Aros fixos

Secção dos aros fixos de 55 mm ou 80 mm;

Aros fixos com esquadro para montagem a meia esquadria;

Aros fixos tradicionais para mercado interno;

Aros fixos com clip exterior e aba de remate directa de 25 mm ou 45 mm para o mercado francês;

Aros fixos com clip exterior e interior para aplicação de remate de 30 mm para o mercado francês.

Aros móveis

Secção dos aros móveis de 63 mm;

Enchimento para vidro simples ou duplo de 4 mm a 47 mm;

Aros móveis de linha recta, curva, tradição ou oval (sem bite);

Aros móveis com esquadro para montagem a meia esquadria;

Perfil inversor de linha recta.

Dimensionamento e manobralidade

Dimensões mínimas - máximas de folha: 400 mm - 1500 mm (L); 400 mm - 2700 mm (H);

Possibilidades de abertura: fixo, batente interior 1 ou 2 folhas com oscilo-batente, exterior, basculante, projectante, harmónio e oscilo-paralela;

Estanquidade assegurada através de juntas triplas em EPDM.

Performances

Sistema certificado por laboratório notificado para Ensaios Tipo Inicial (ITT) de acordo com a norma de produto EN 14351-1 para efeitos de Marcação CE.

Categorias alcançadas na avaliação do sistema AXi tipologia janela:

1. Permeabilidade ao ar: Classe 4 (norma de ensaio EN 1026)
2. Estanquidade à água: Classe 9A (norma de ensaio EN 1027)
3. Resistência ao vento: Classe C5 (norma de ensaio EN 12211)

Categorias alcançadas na avaliação do sistema ATi tipologia porta:

1. Permeabilidade ao ar: Classe 4 (norma de ensaio EN 1026)
2. Estanquidade à água: Classe E750 (norma de ensaio EN 1027)
3. Resistência ao vento: Classe C2 (norma de ensaio EN 12211)
4. Resistência à torção estática: Apto 350N (norma de ensaio EN 14609)

Coefficiente de transmissão térmica de vão de 2 folhas com 1.20 m x 1.50 m com vidro $U_g = 0.7 \text{ W/m}^2\text{K}$, com intercalar efeito "Warm Edge":

• $U_w = 1.57 \text{ W/m}^2\text{K}$

Coefficiente de atenuação acústica de vão de 2 folhas com vidro 4/14 (gás árgon)/6:

• $R_w (C; C_{tr}) = 34 \text{ dB} (-1; -4)$

Zonas de aplicação segundo RCCTE (em função do valor U_g): I1, I2, I3, V1, V2, V3.

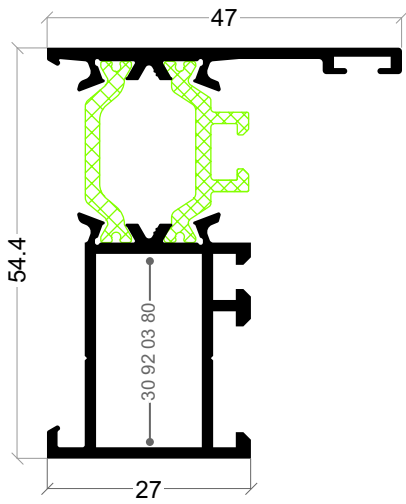

ATi-03
Aro fixo

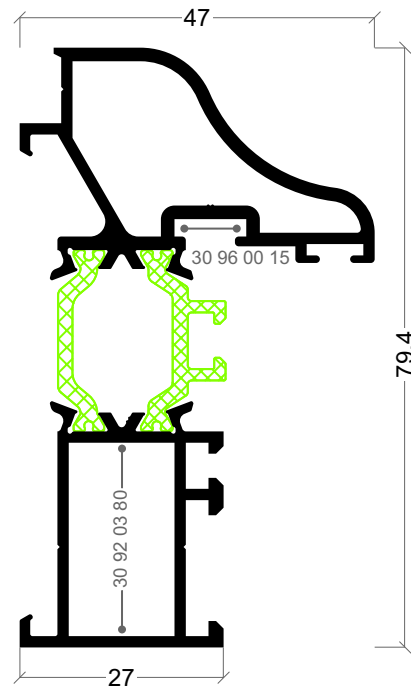

ATi-49
Aro fixo

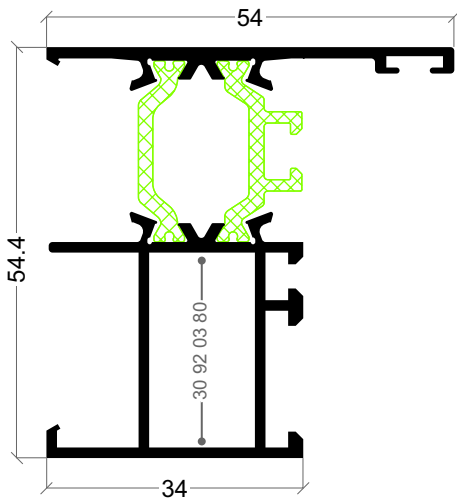

ATi-81
Aro fixo

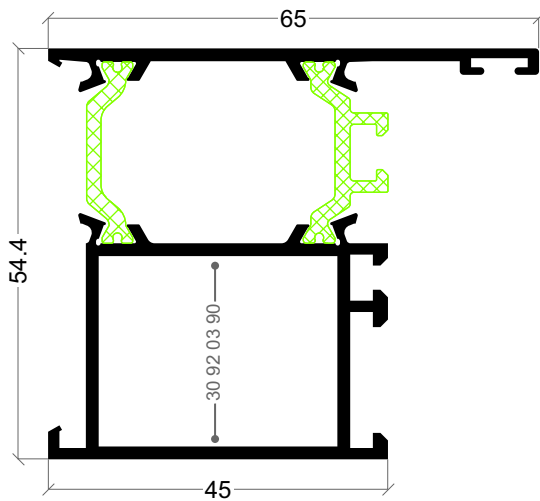

ATi-08
Aro fixo

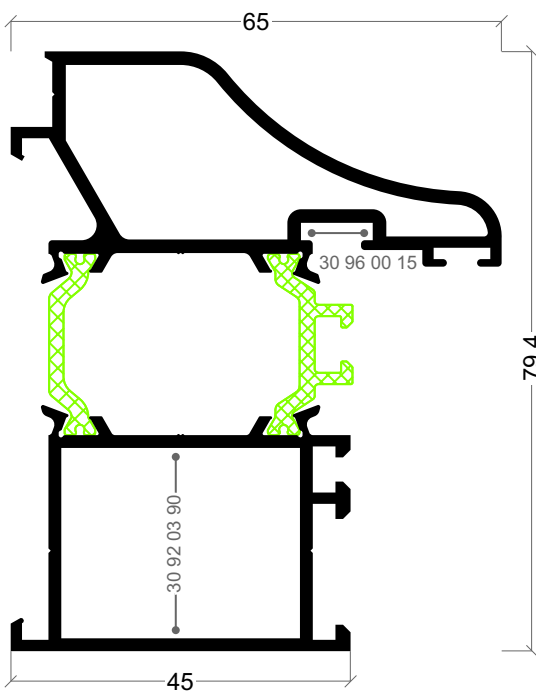

ATi-50
Aro fixo

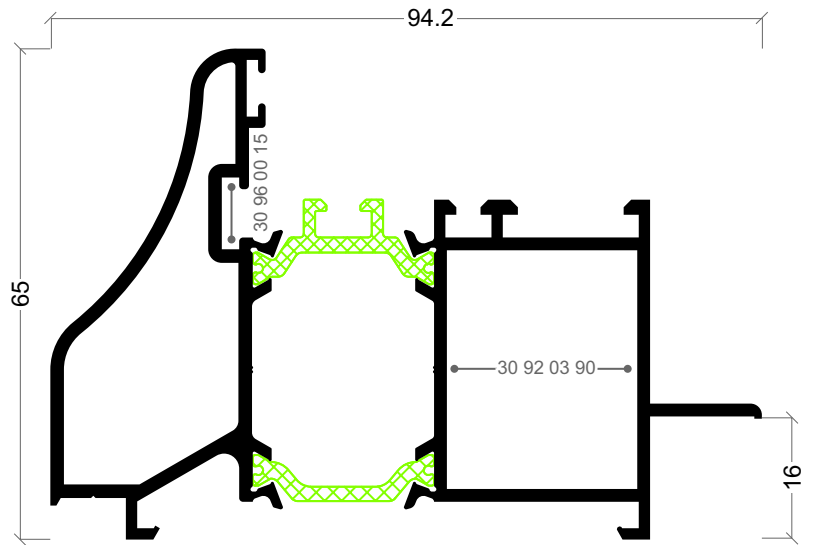

ATi-51
Aro fixo para apanelado

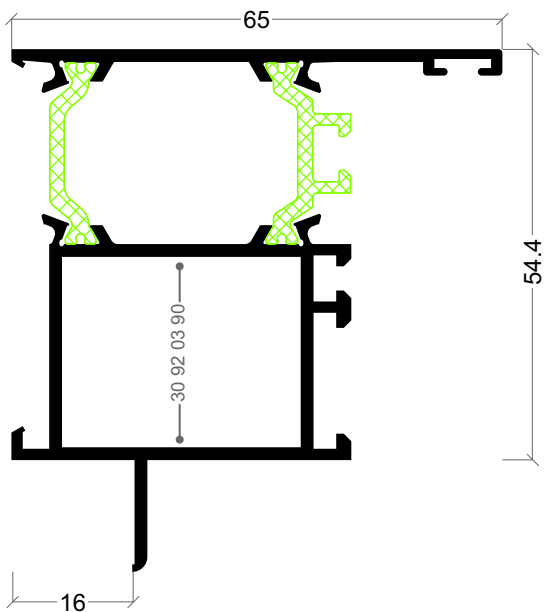

ATi-48
Aro fixo para apanelado

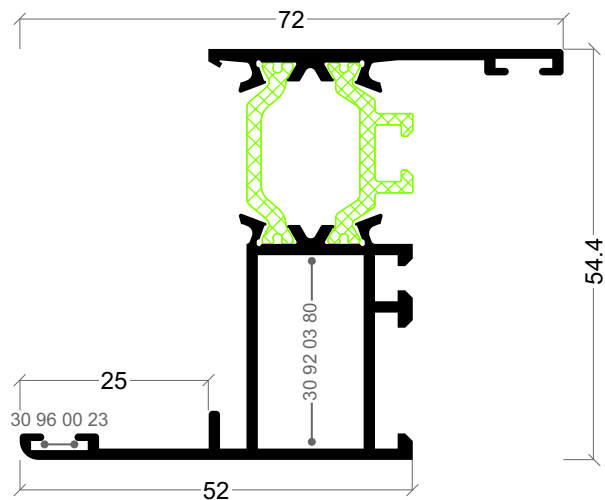

ATi-25
Aro fixo com remate

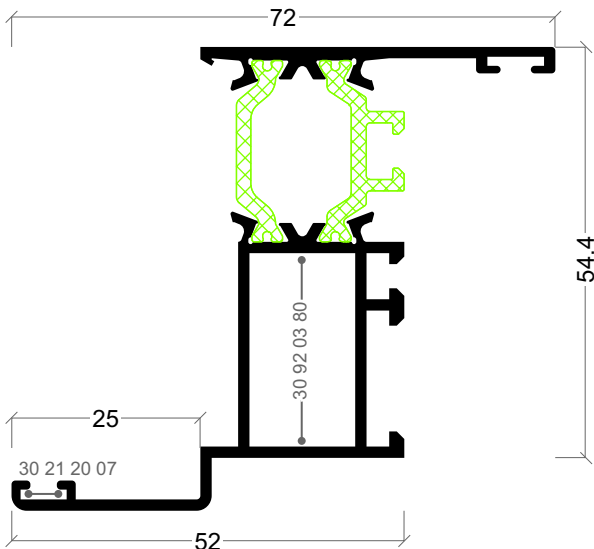

ATi-19
Aro fixo com remate

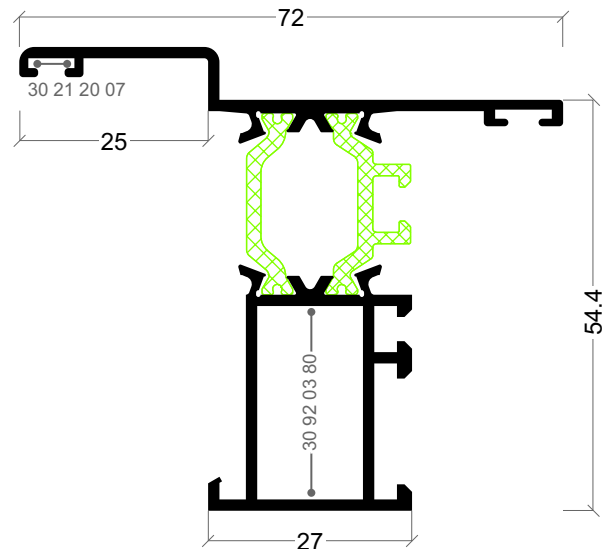

ATi-23
Aro fixo com remate

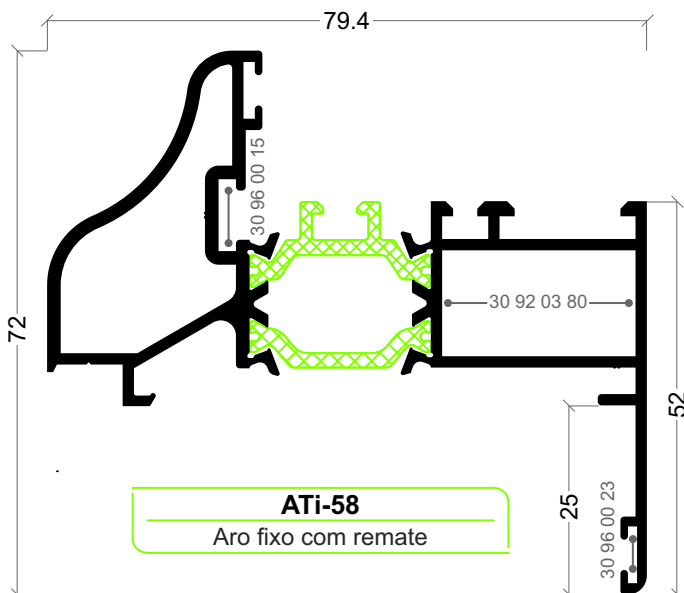

ATi-58
Aro fixo com remate

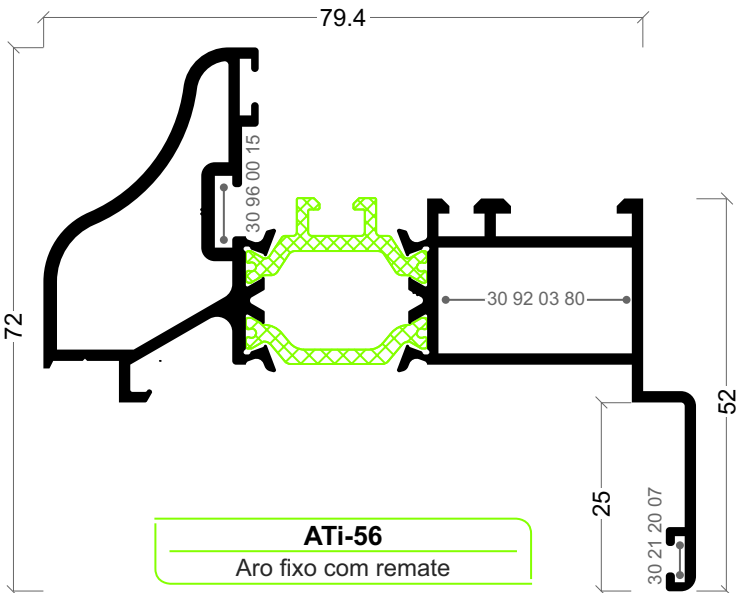

ATi-56
Aro fixo com remate

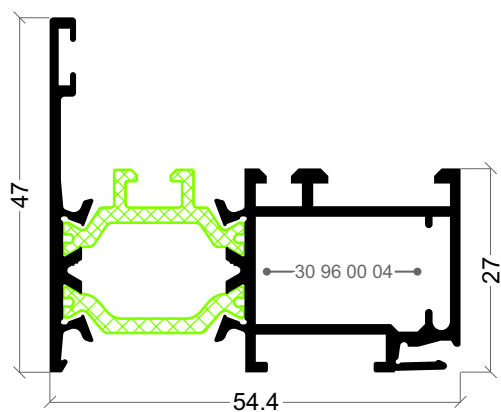

ATi-90
Aro fixo

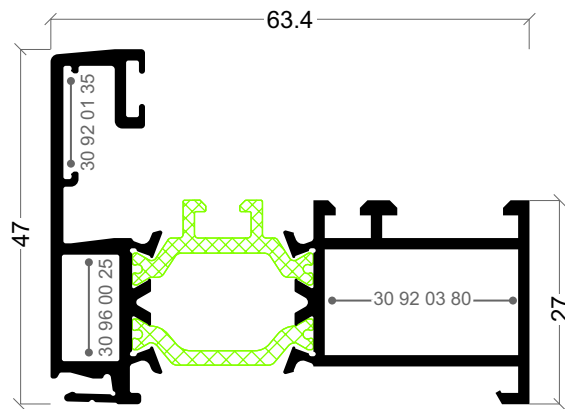

ATi-86
Aro fixo

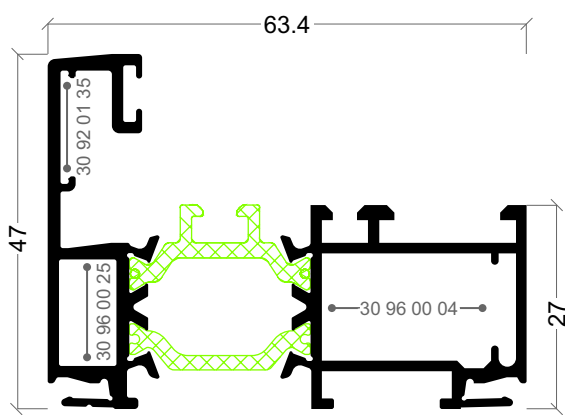

ATi-87
Aro fixo

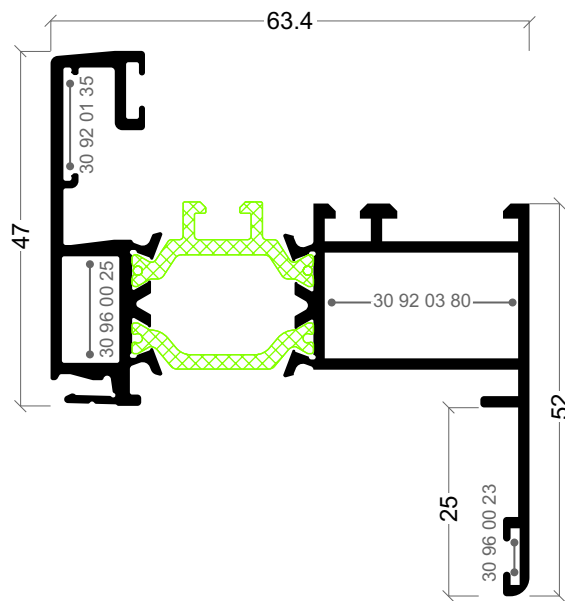

ATi-85
Aro fixo com remate

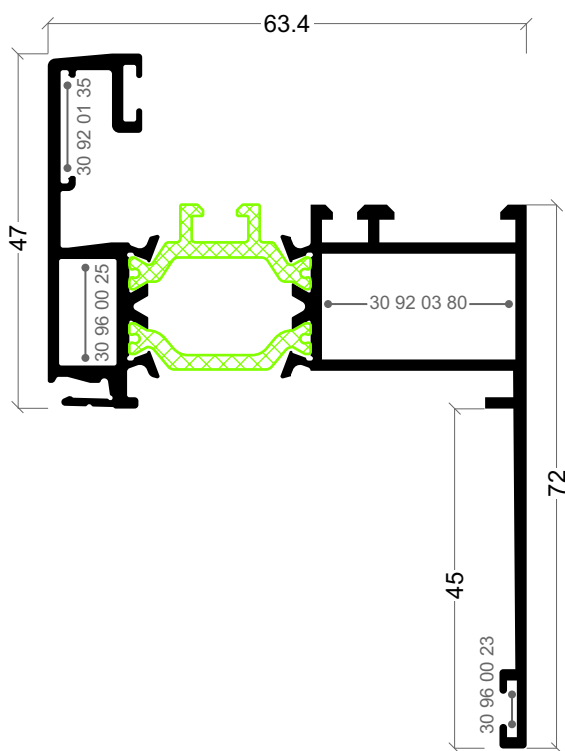

ATi-82
Aro fixo com remate

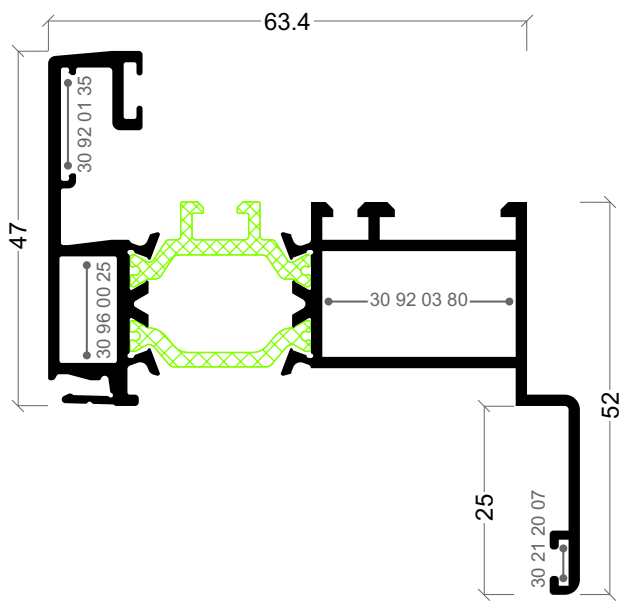

ATi-84
Aro fixo com remate

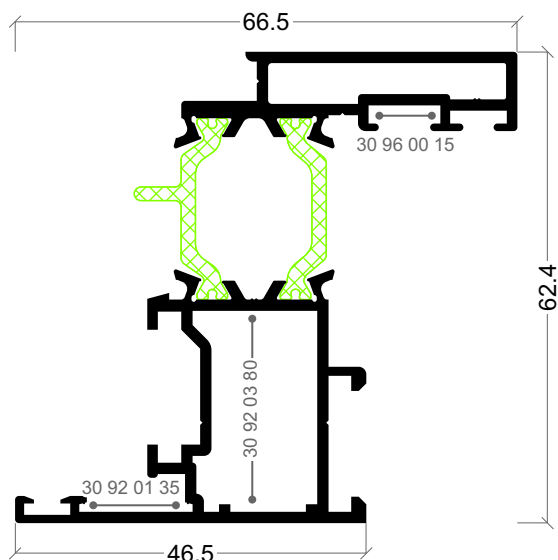

ATi-64
Aro móvil

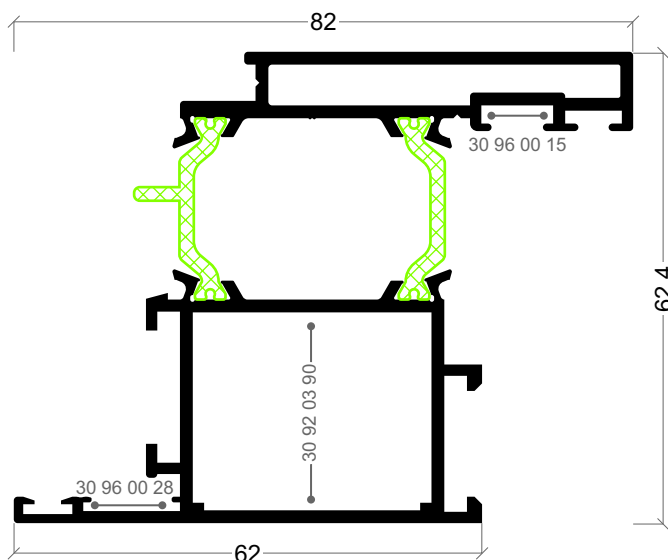

ATi-65
Aro móvil

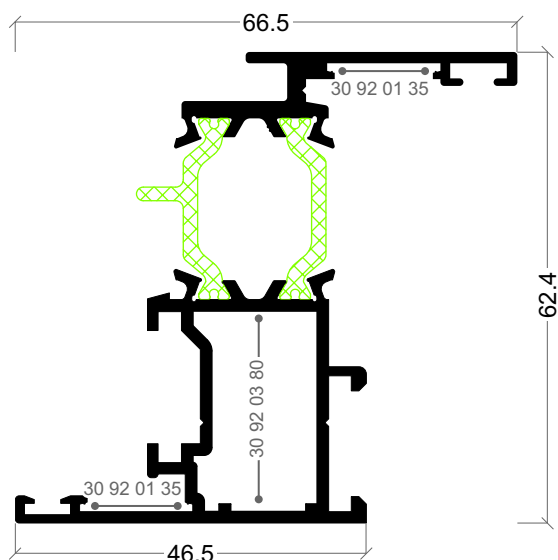

ATi-02
Aro móvil

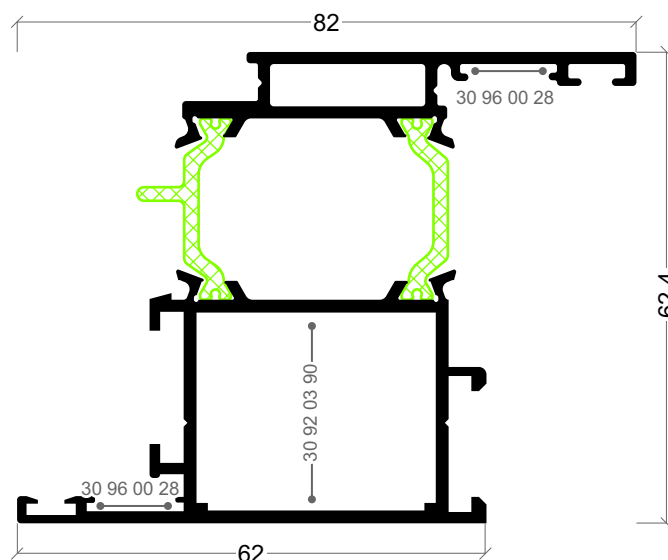

ATi-07
Aro móvil

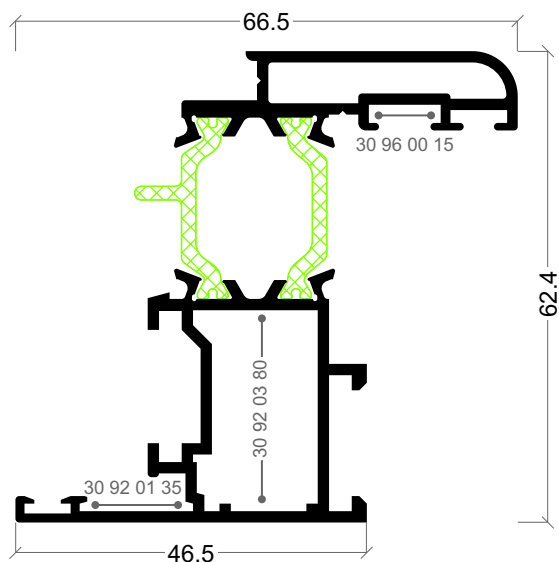

ATi-05
Aro móvil

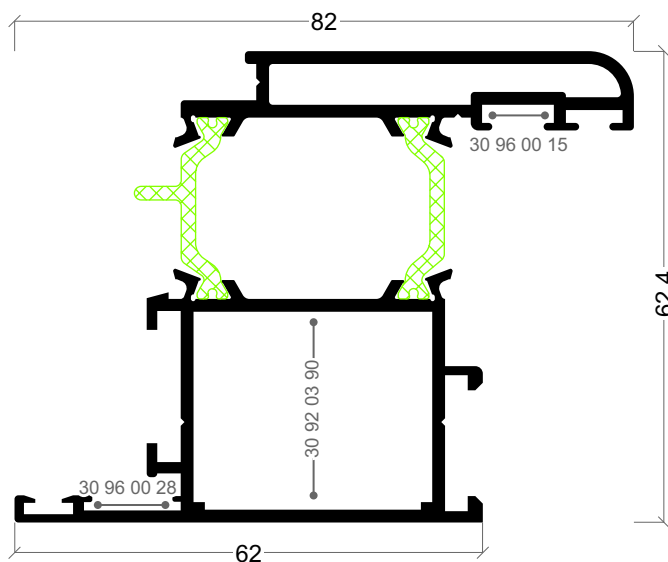

ATi-10
Aro móvil

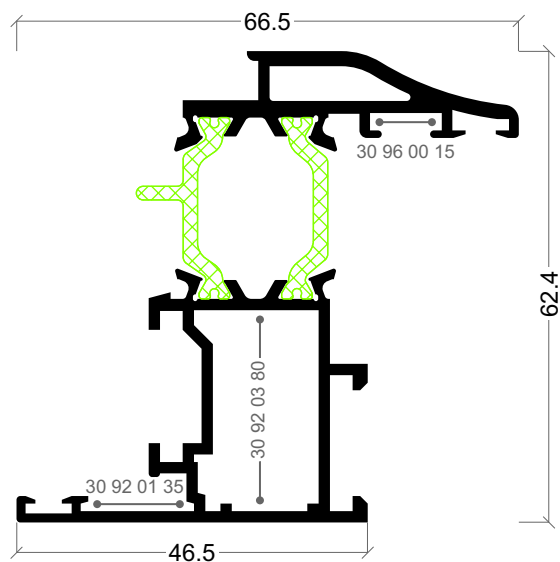

ATi-52
Aro móvel

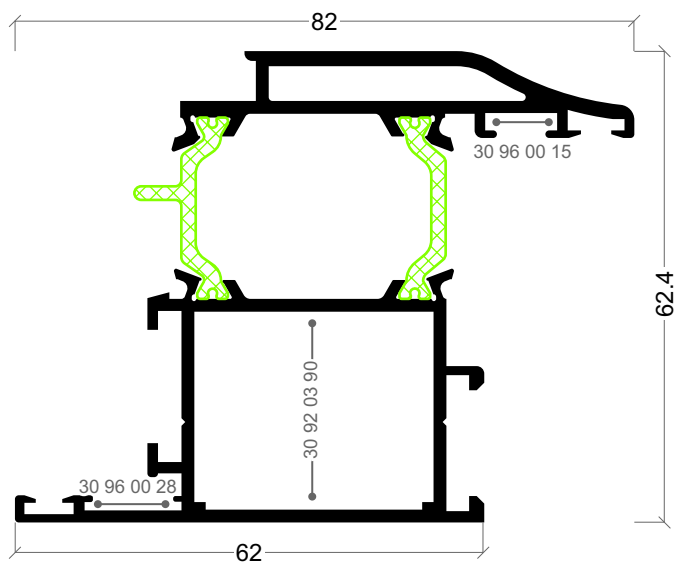

ATi-53
Aro móvel

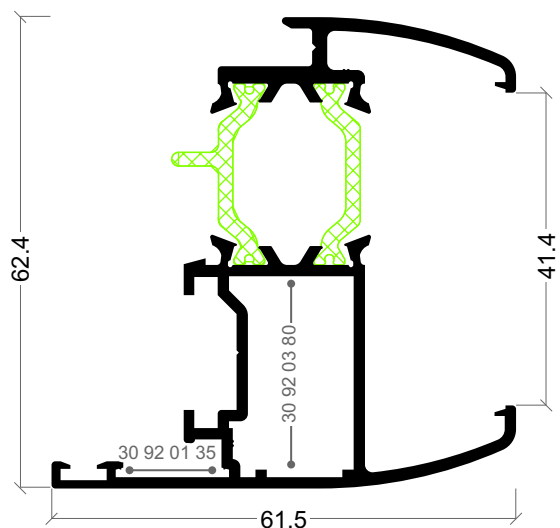

ATi-76
Aro móvel

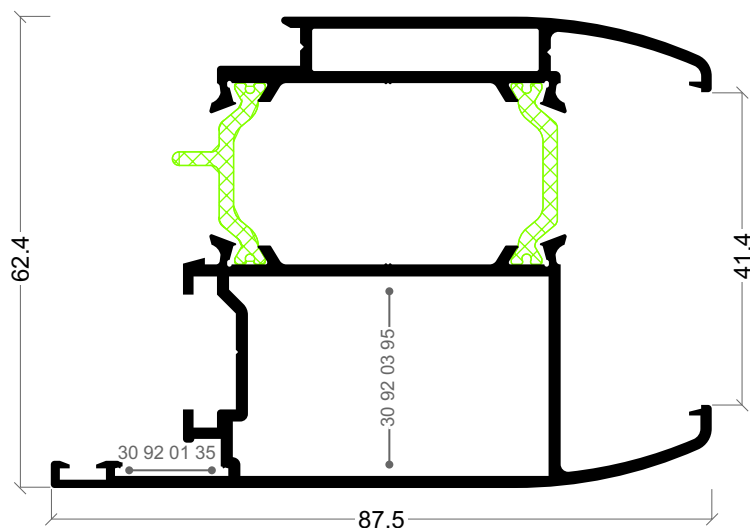

ATi-77
Aro móvel

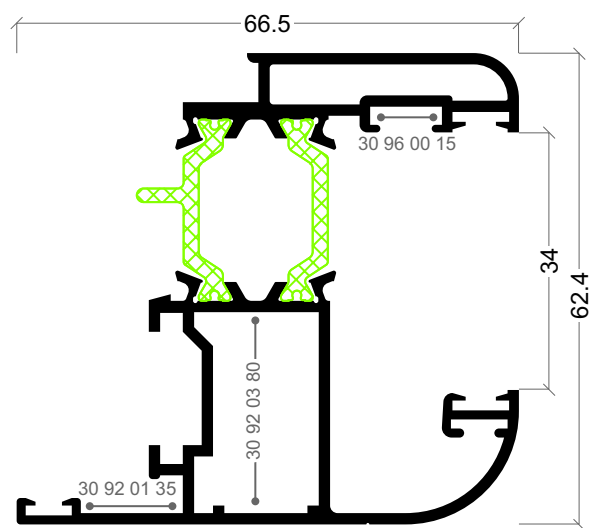

ATi-44
Aro móvel

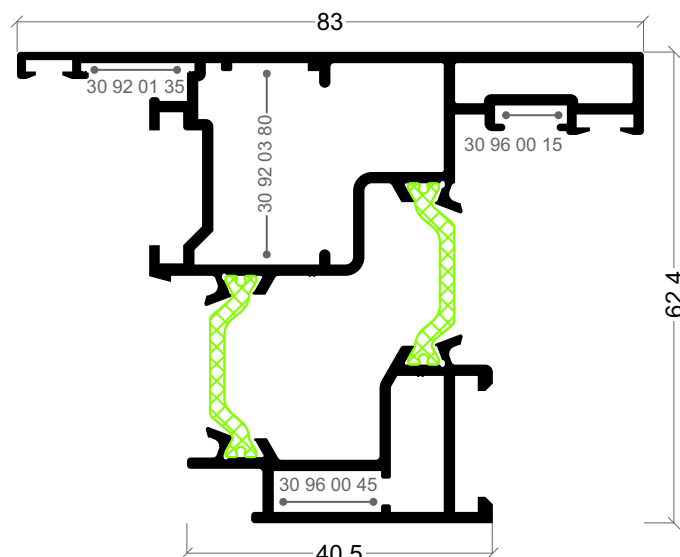

ATi-60
Aro móvel abertura exterior

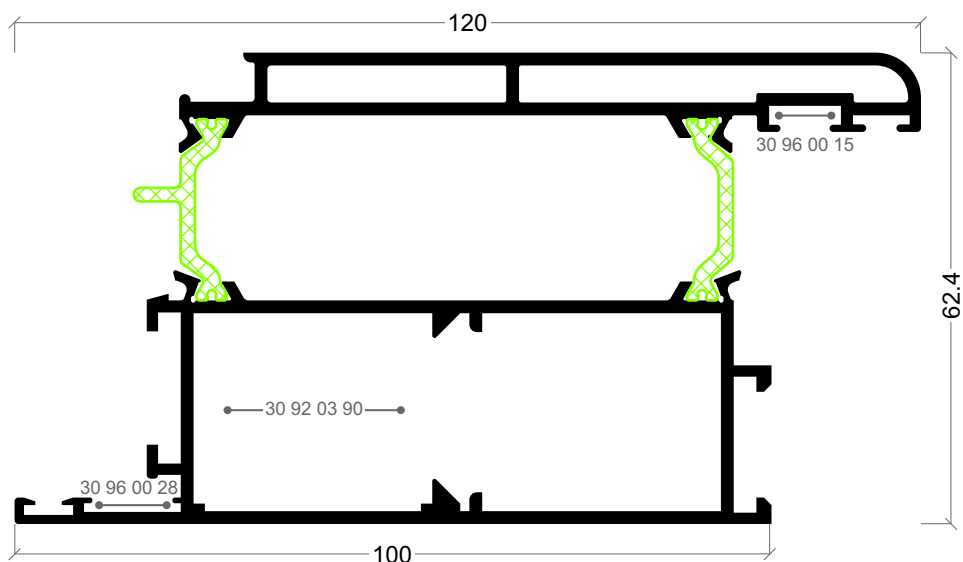

ATi-66
Aro móvel

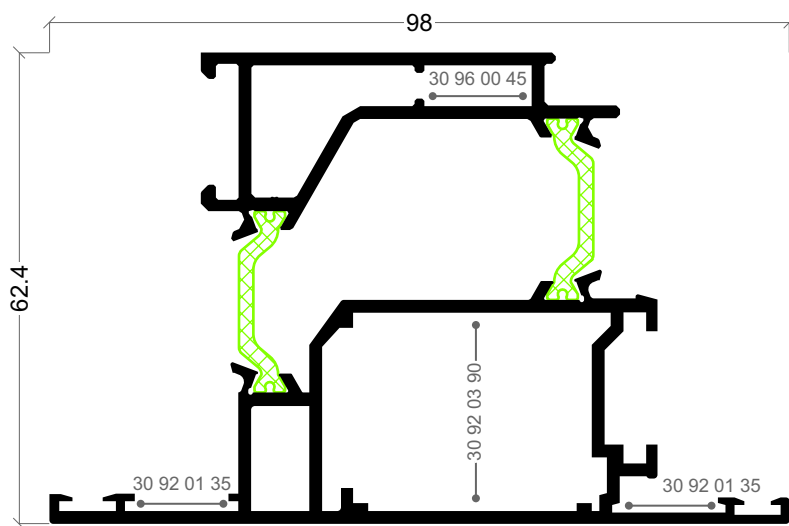

ATi-71
Aro móvel abertura exterior

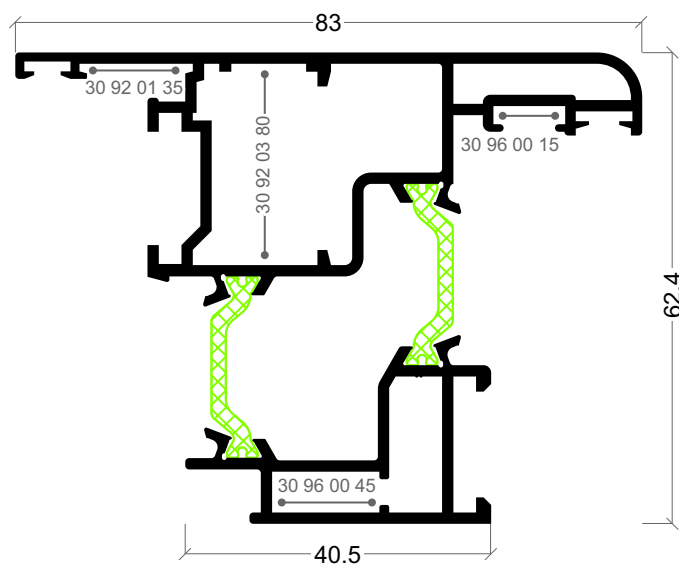

ATi-59
Aro móvel abertura exterior

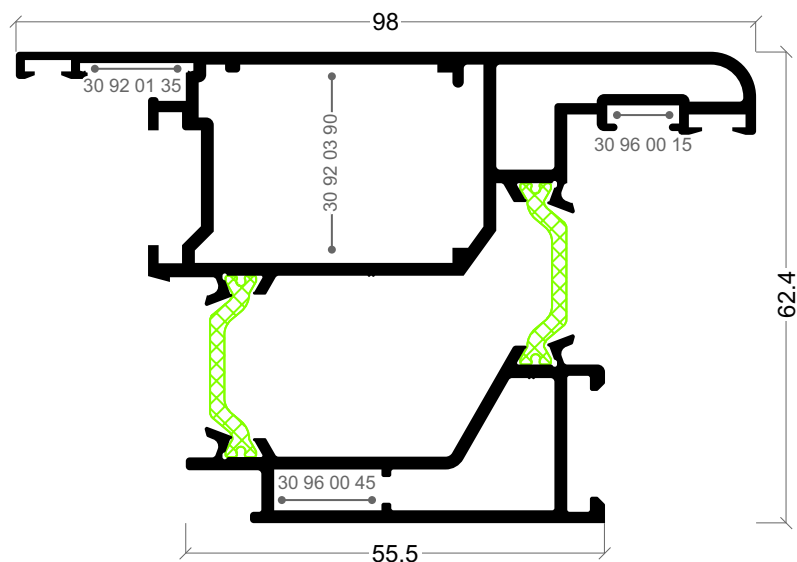

ATi-62
Aro móvel abertura exterior

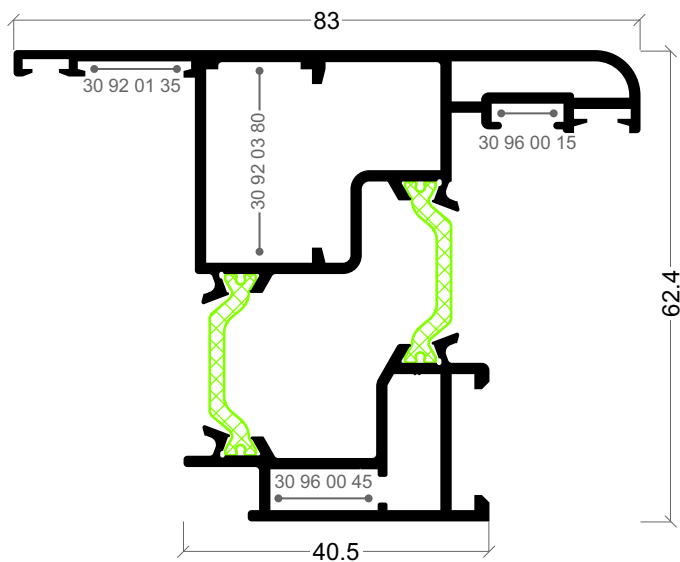

ATi-63
Aro móvel projectante

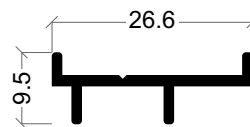

AXi-32
Complemento abertura projectante

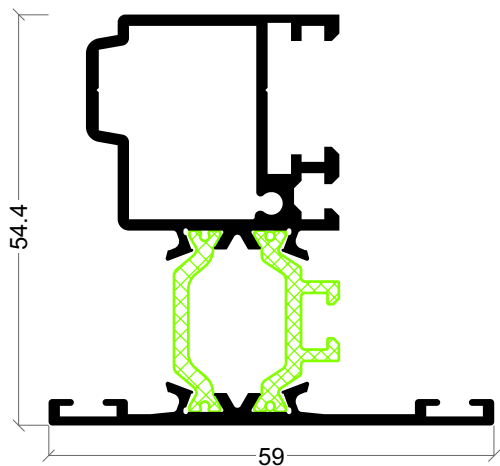

ATi-04
Inversor

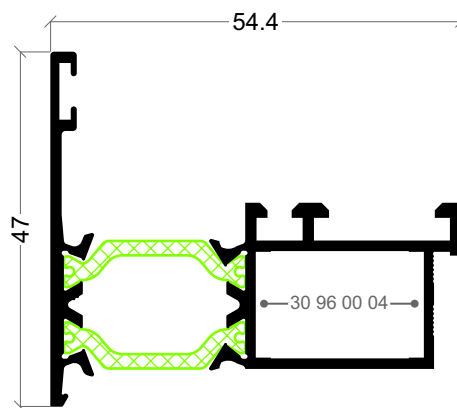

ATi-75
Inversor abertura exterior

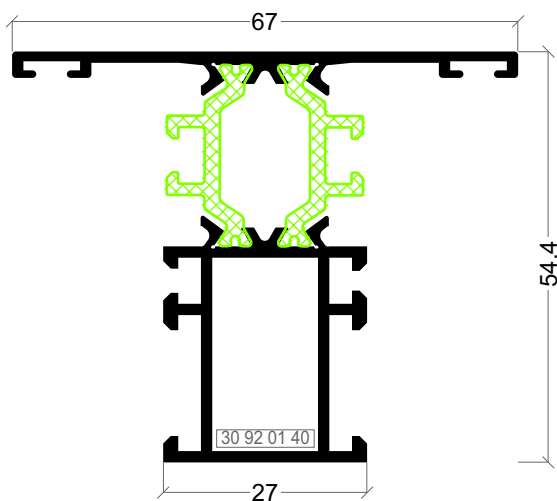

ATi-01
Travessa

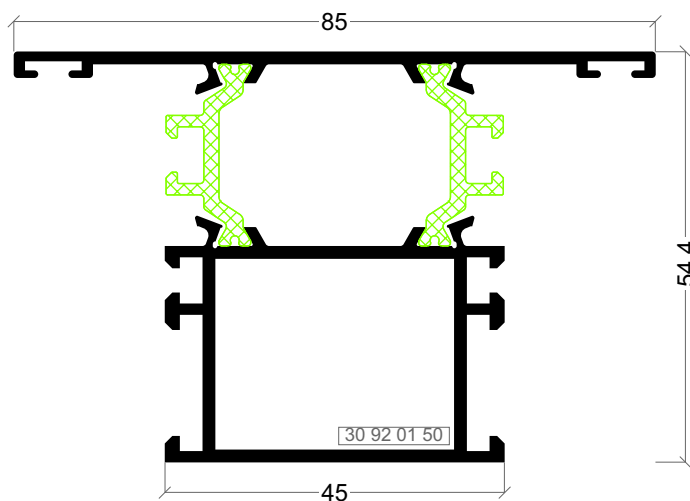

ATi-06
Travessa

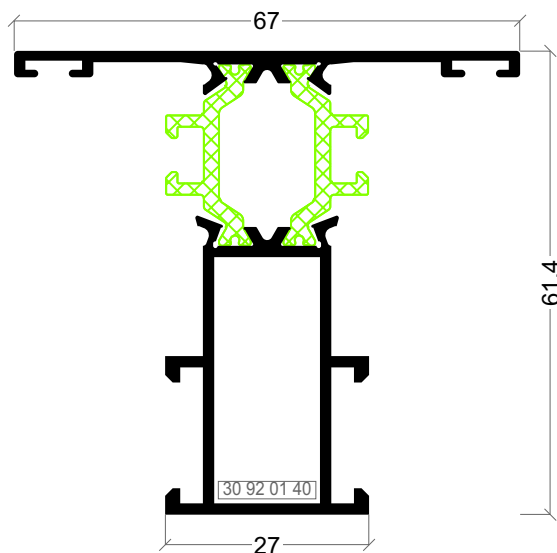

ATi-09
Travessa

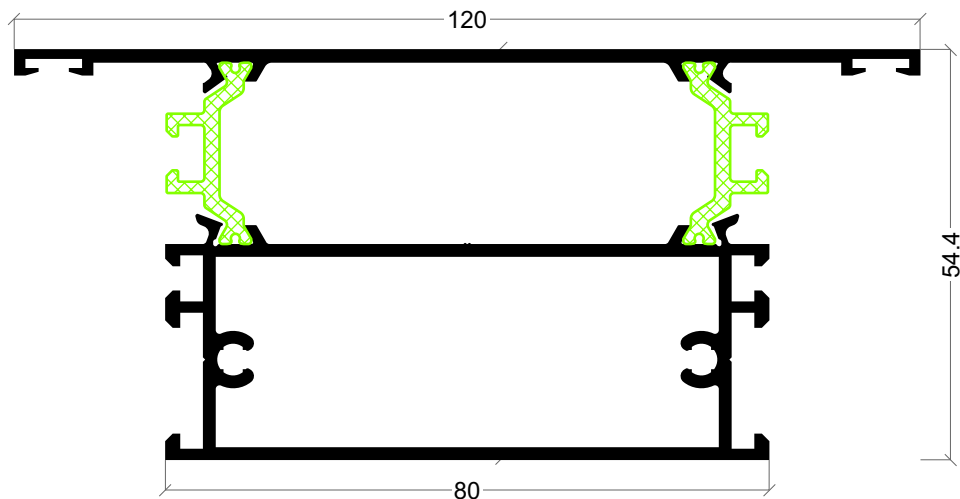

ATi-12
Travessa

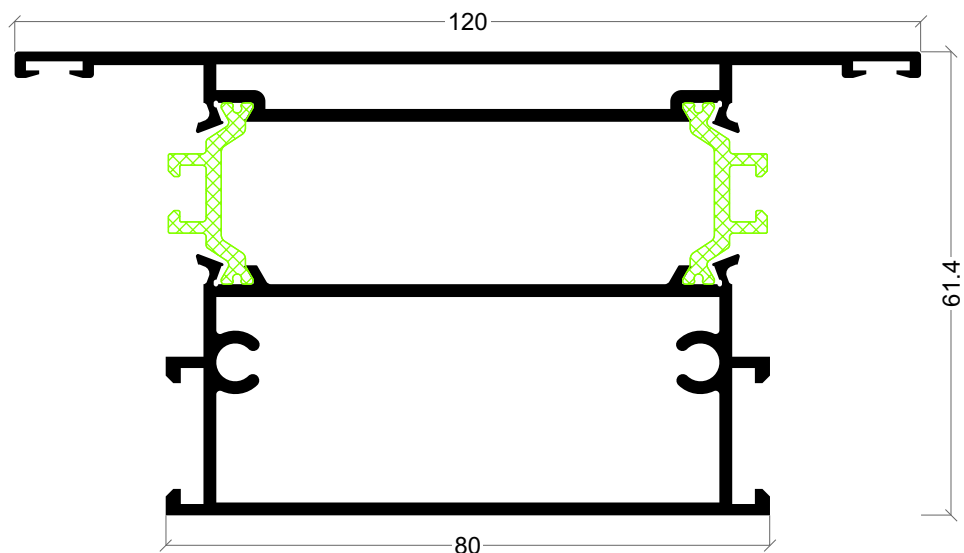

ATi-14
Travessa

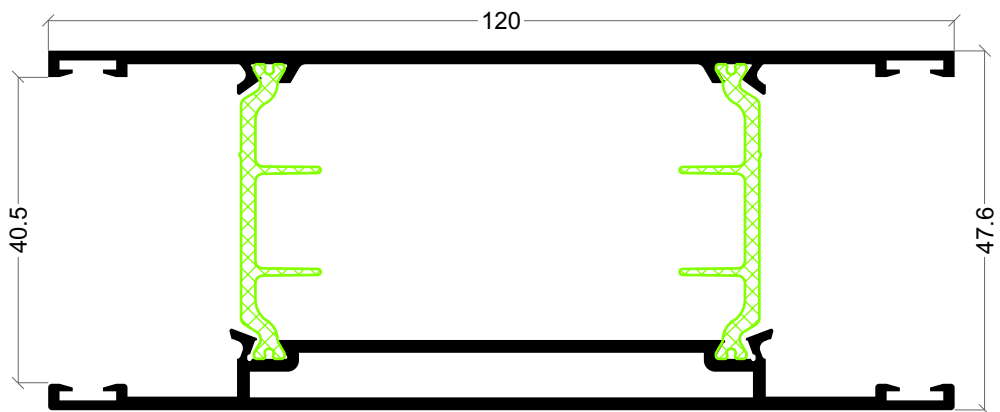

ATi-79
Travessa para ATi-77

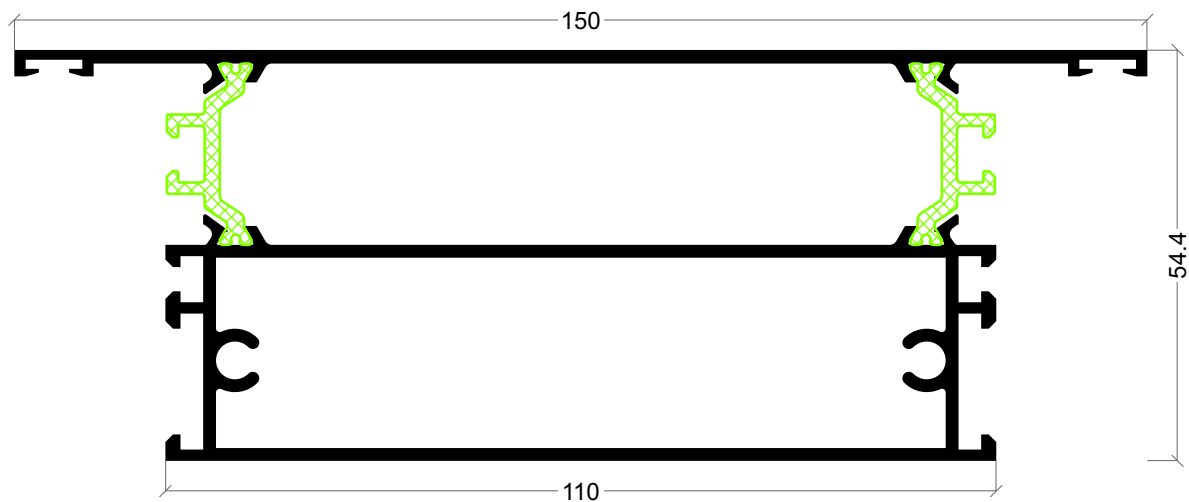

ATi-13
Travessa

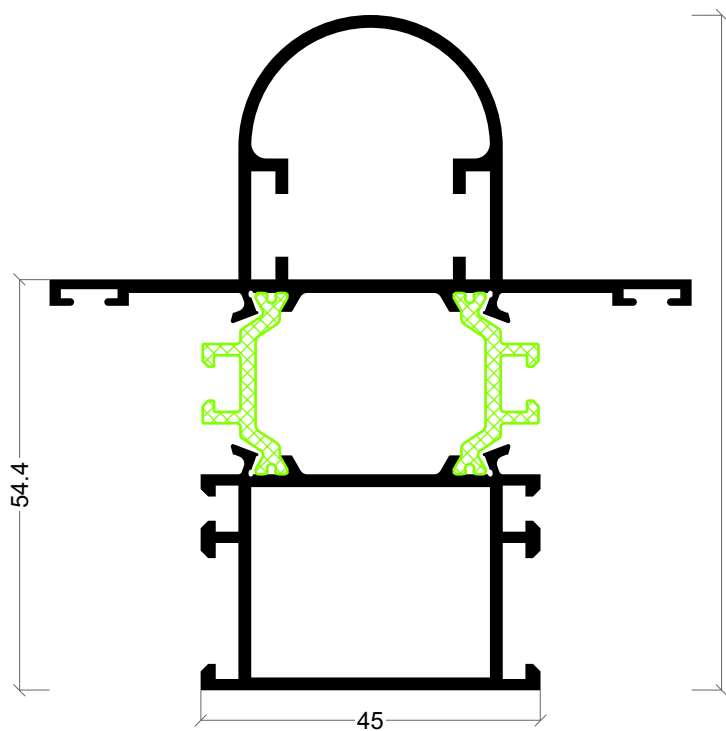

ATi-17
Montante curvo

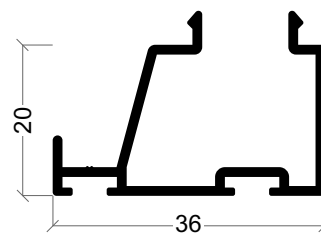

AX-15
Bite remate

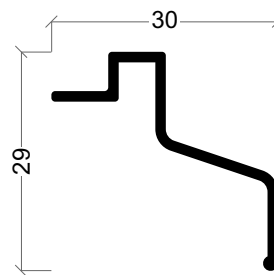

AXi-45
Pingadeira

4.4

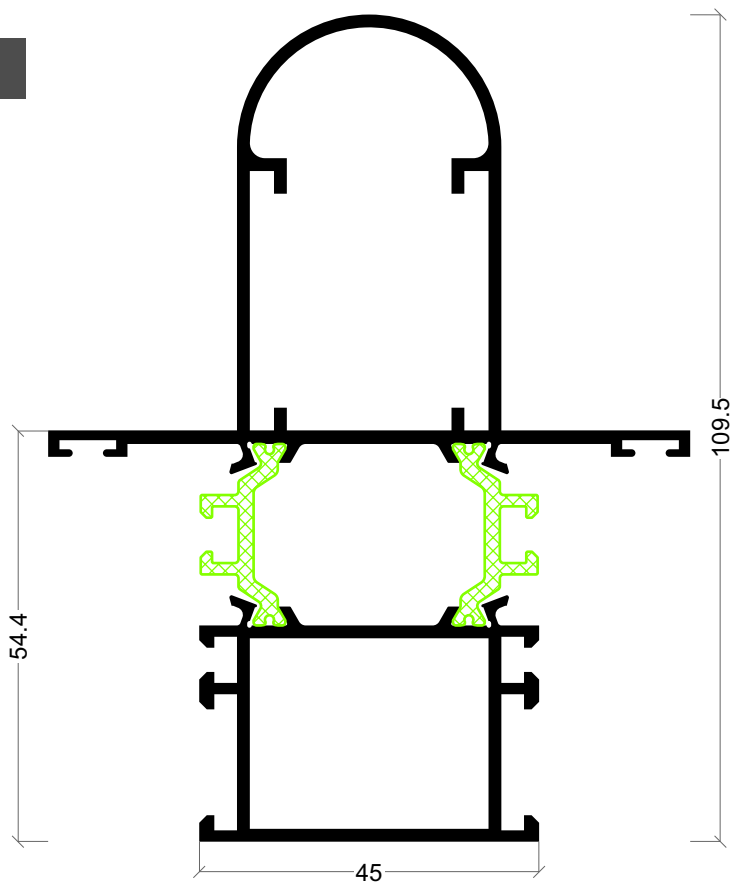

ATi-18
Montante curvo

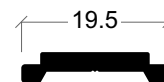

AX-19
Vareta

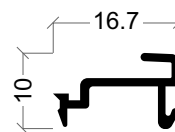

AX-33
Mola Bite

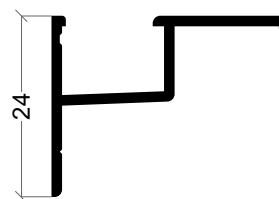

Y-20
Recolha de águas condensação

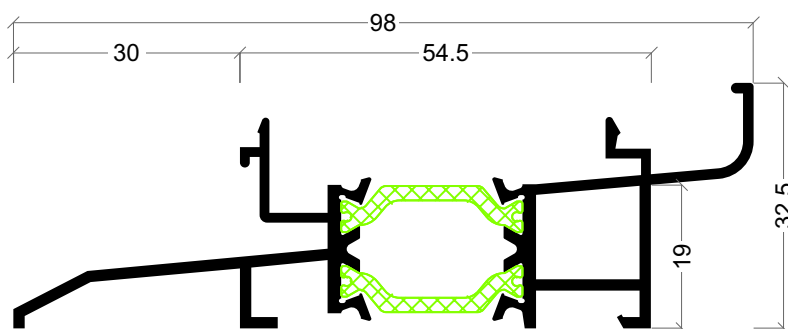
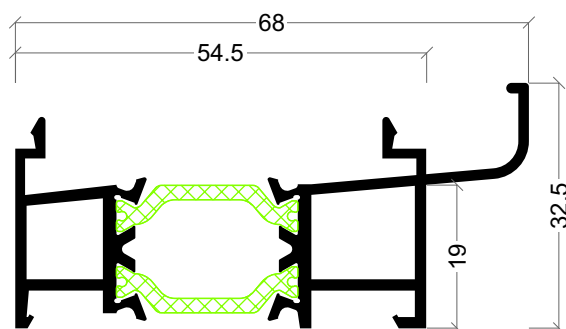
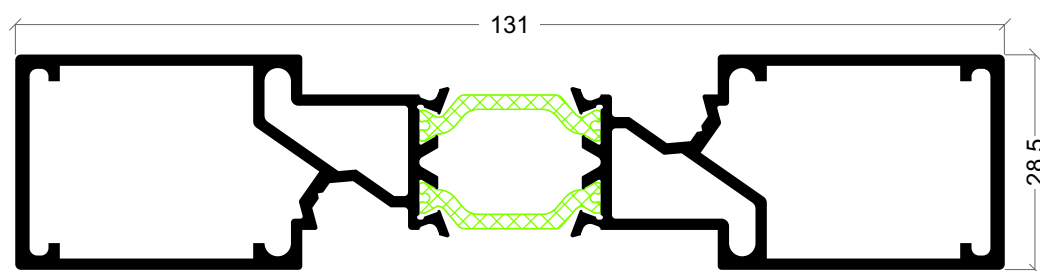
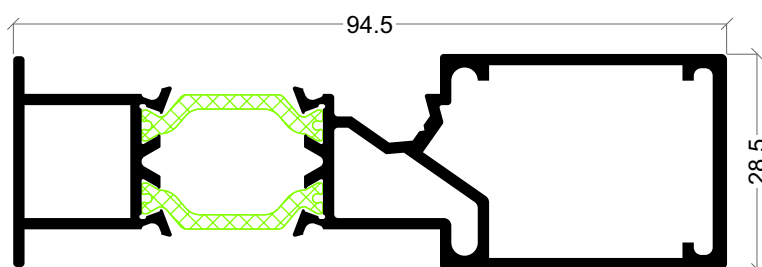
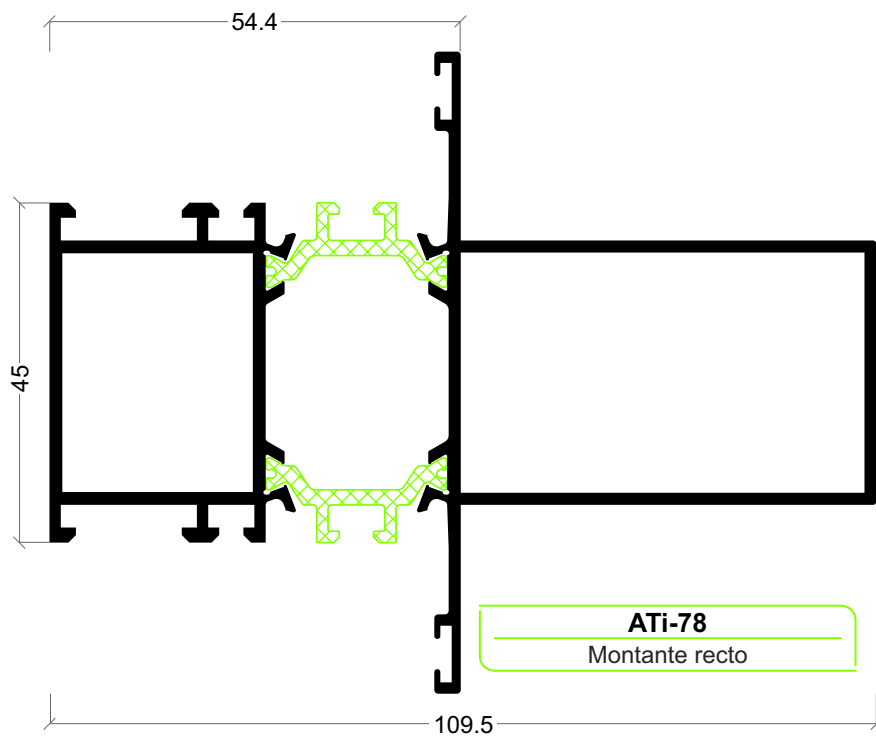

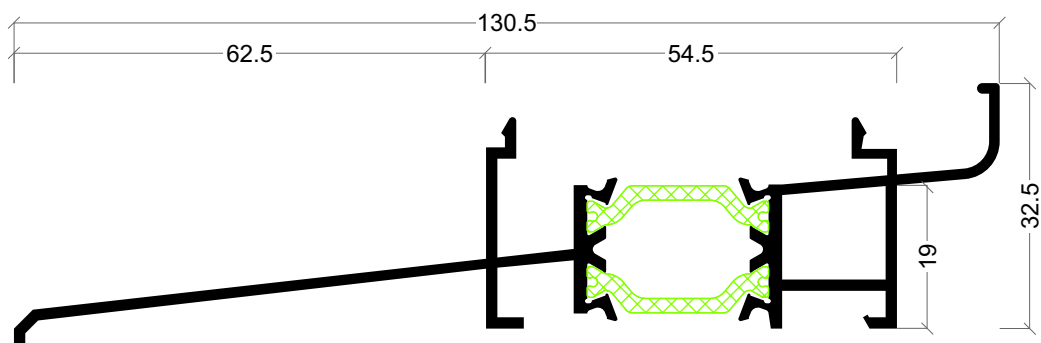

ATi-30
Soleira condensação

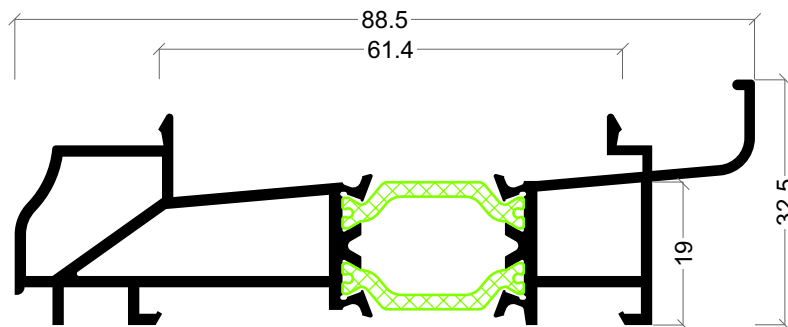

ATi-55
Soleira condensação

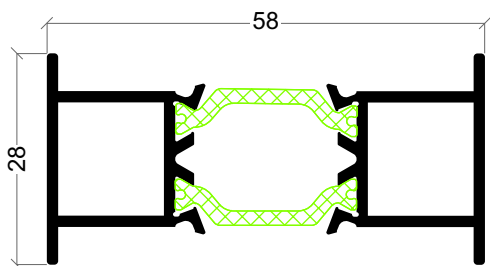

ATi-54
União de aros

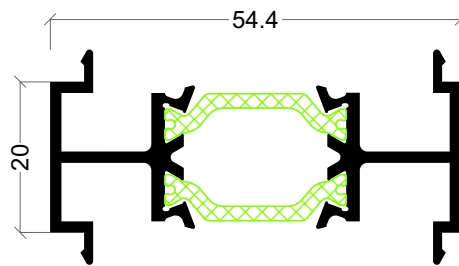

ATi-15
União de aros

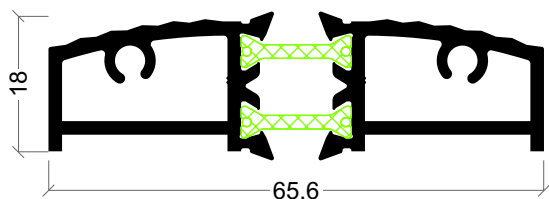

AXi-69
Remate inferior porta

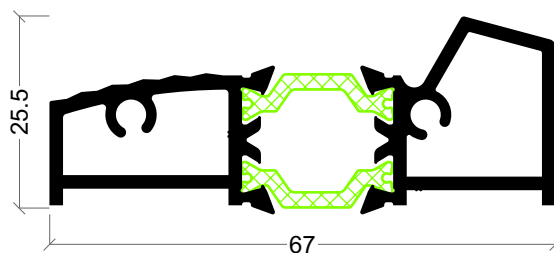

ATi-70
Remate inferior porta

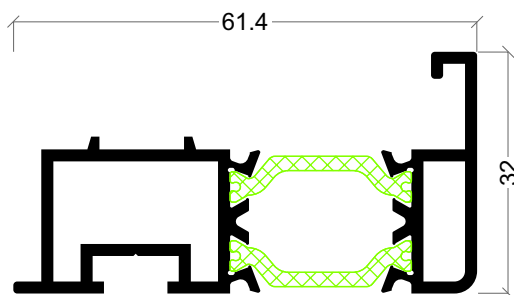

ATi-42
Remate almofada

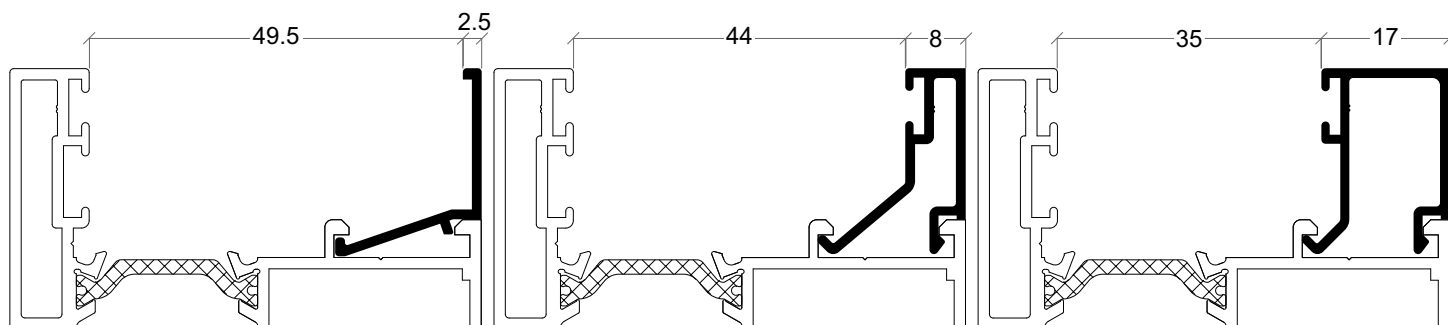

AX-69

AX-74

AX-46

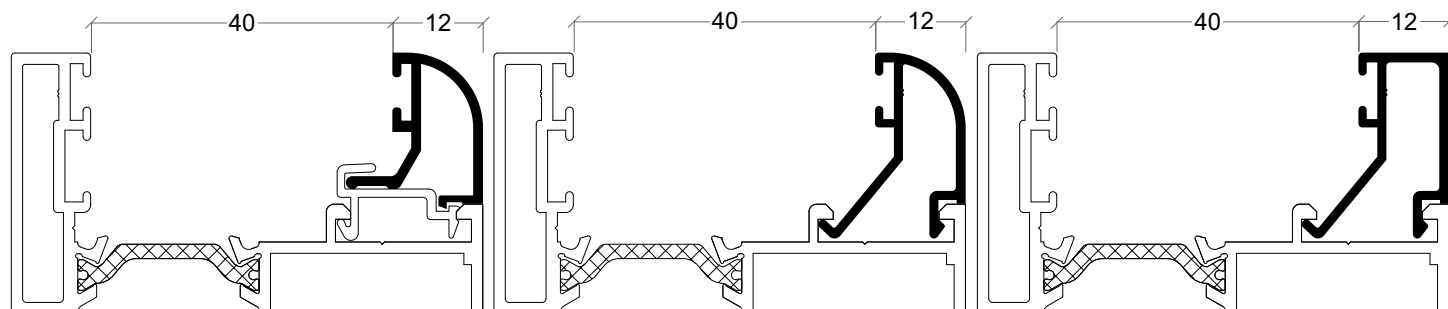

AX-37

AZ-08

AX-36

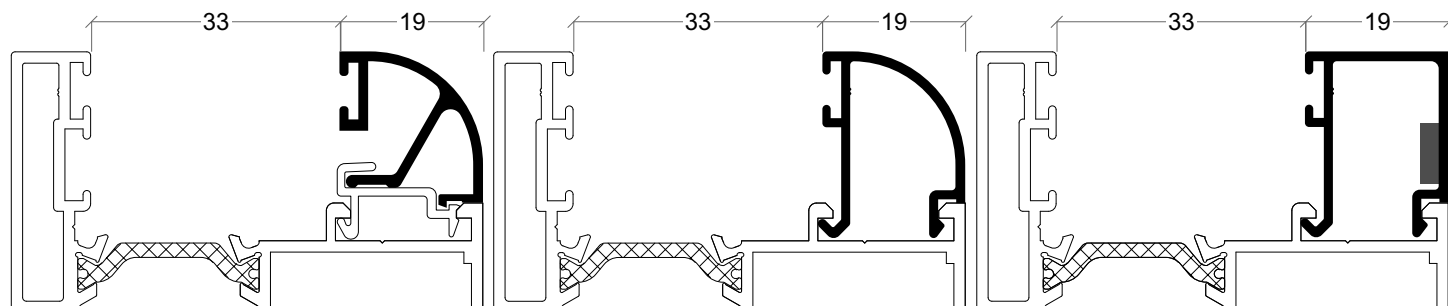

AX-30

AZ-07

AX-35

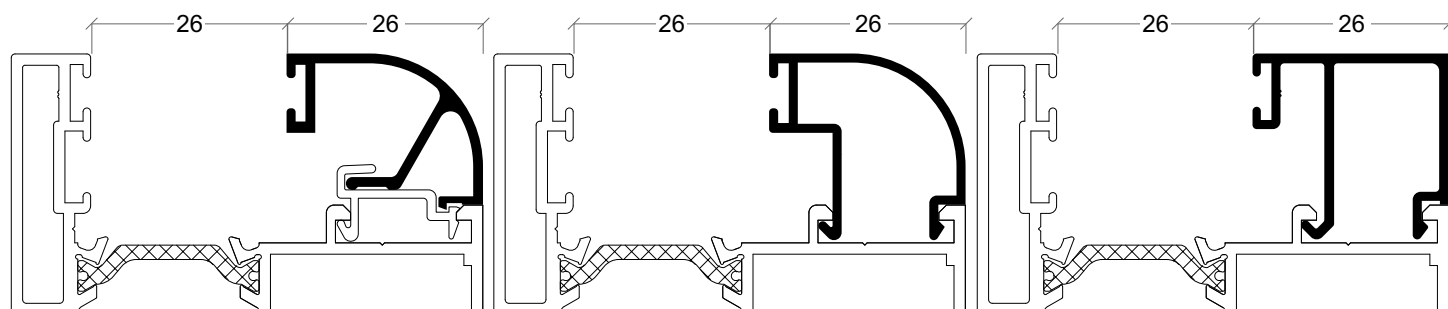

AX-29

AZ-06

AX-31

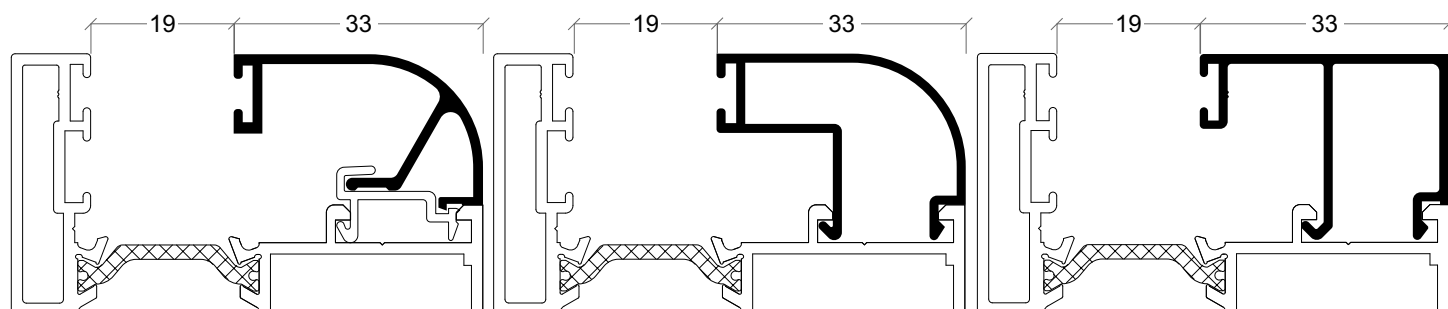

AX-39

AZ-28

AX-34

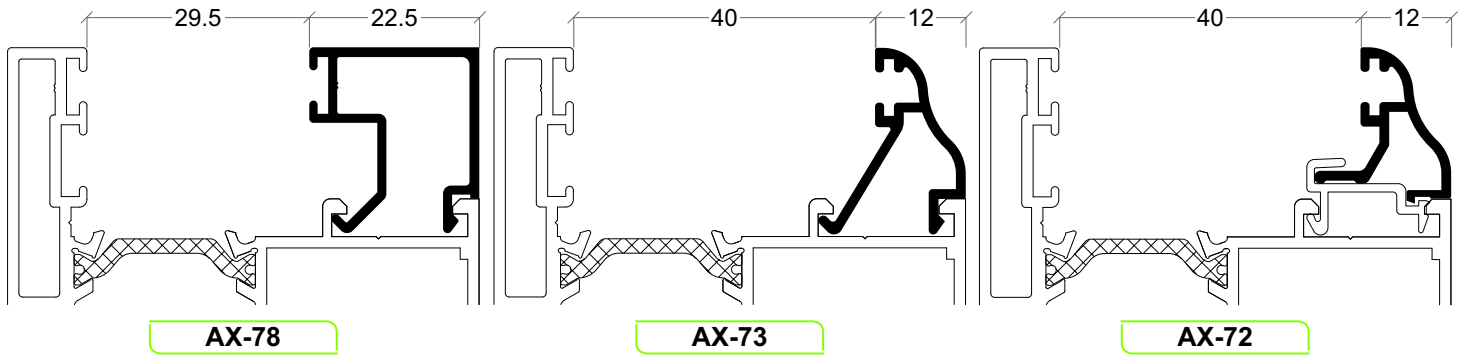

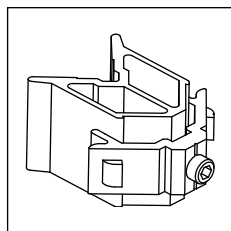

30 20 30 09

Esquadro móvel pivotante

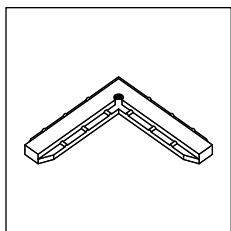

30 21 20 07

Esquadro de alinhamento

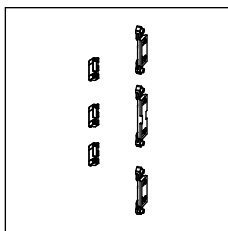

30 90 20 40

Transmissão abertura exterior

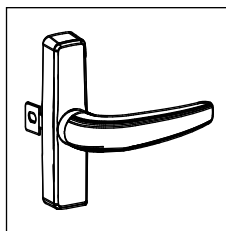

30 90 20 50/51

Cremona para abertura exterior

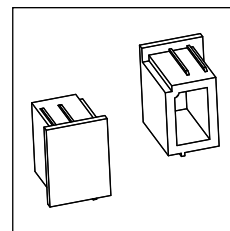

30 91 21 20

Jogo topos condensação Y-20

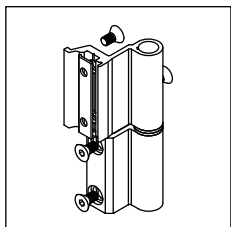

30 92 00 20/21

Dobradiça C.E. branco/preto

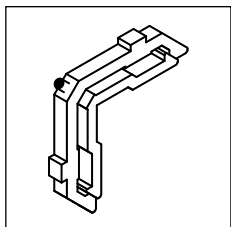

30 96 00 38

Esquadro alinhamento exterior

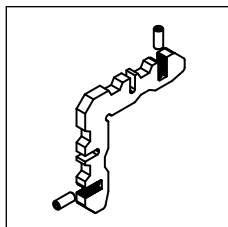

30 96 00 45

Esquadro alinhamento exterior com parafusos

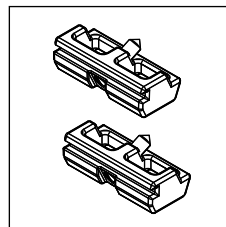

30 92 00 50

Complemento fecho

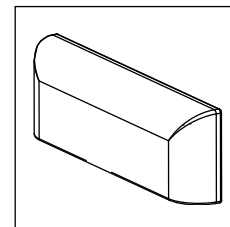

30 92 01 00/01

Goteiras branco/preto

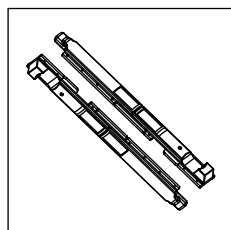

30 92 01 20

Jogo fecho C.E.

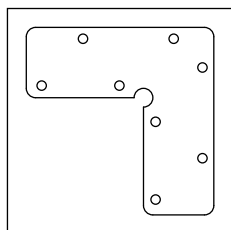

30 92 01 35

Esquadro alinhamento

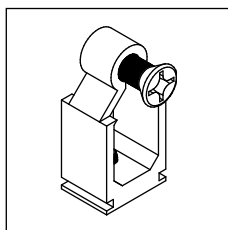

30 92 01 40

União topos janela

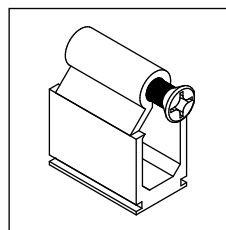

30 92 01 50

União topos porta

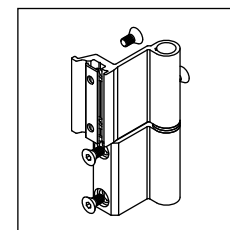

30 92 01 70/80

Dobradiça 3 folhas branco/preto

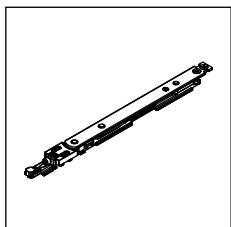

30 92 02 10/11/12

Compasso oscilo 300/400/500

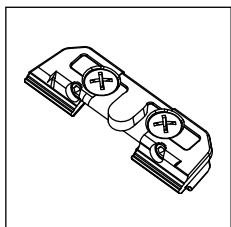

30 92 02 15

Fecho para micro-ventilação

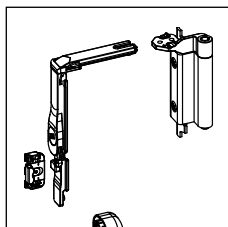

30 92 02 20/21

Kit oscilobatente branco/preto

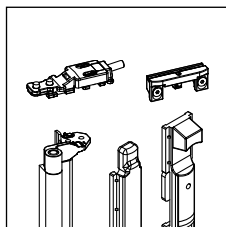

30 92 02 24/25

Kit 2ª folha oscilobatente branco/preto

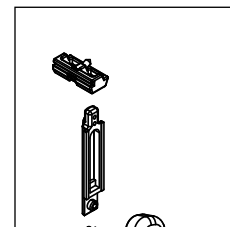

30 92 03 10/11

Kit cremone branco/preto

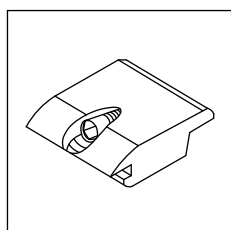

30 92 02 60

Apoio da folha

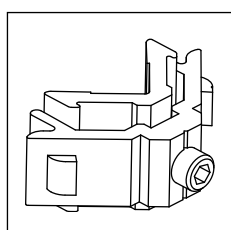

30 92 03 80

Esquadro janela

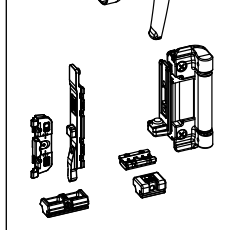

30 92 02 20/21

Kit oscilobatente branco/preto

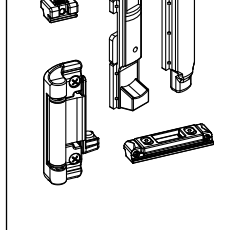

30 92 02 24/25

Kit 2ª folha oscilobatente branco/preto

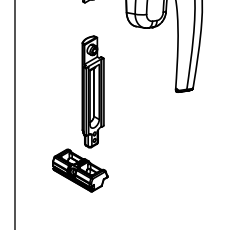

30 92 03 10/11

Kit cremone branco/preto

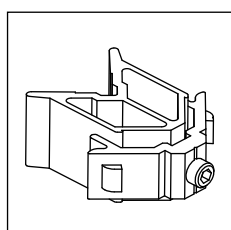

30 92 03 90

Esquadro porta

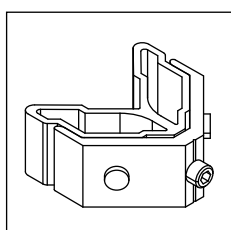

30 92 04 10

Esquadro janela abertura exterior

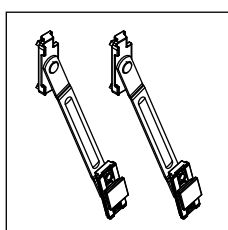

30 92 04 75

Jogo compasso basculante

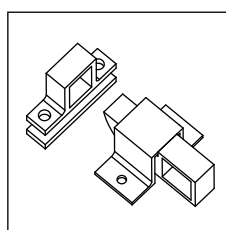

30 92 04 76/77

Fecho clack (branco/preto)

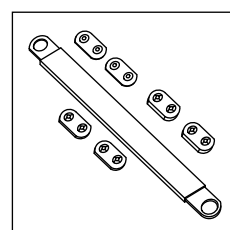

30 92 04 85

Jogo compasso

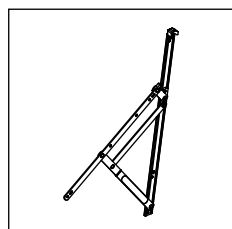

30 92 04 90
Compasso SEN-550 (até 70kg /folha)

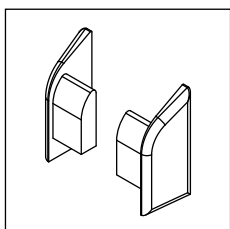

30 92 05 00
Jogo topos

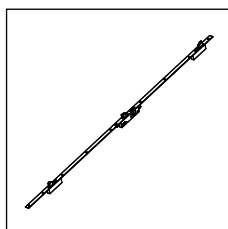

30 92 05 10
Fechadura 3 pontos 35 mm

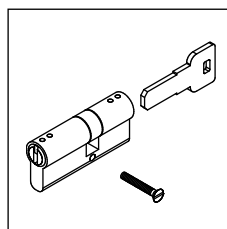

30 92 05 52
Canhão de segurança

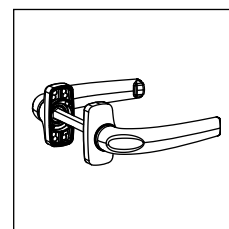

30 92 05 60/61
Puxador duplo branco/preto

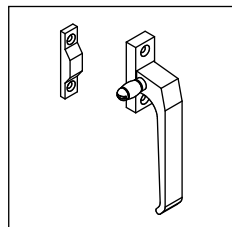

30 92 06 10/11
Cremone de lingueta branco/preto

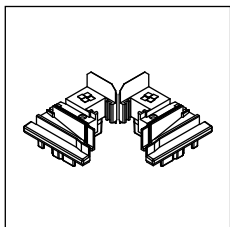

30 93 50 21
Conjunto topos inversores com furo ATi

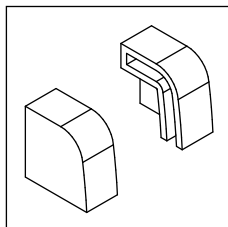

30 96 00 12
Jogo topos condensação

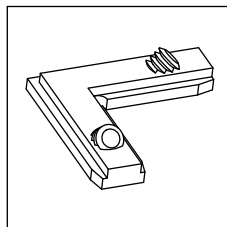

30 96 00 15
Esquadro de alinhamento

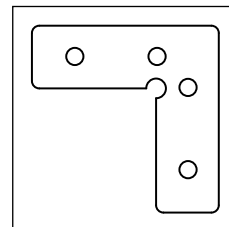

30 96 00 28
Esquadro alinhamento especial ATi-07/10/53/65/66

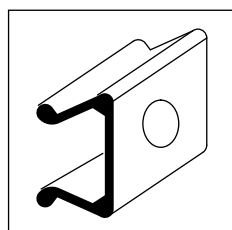

31 03 40 00
Mola para AZ-60

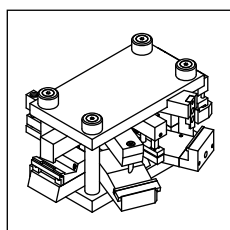

33 96 79 99
Cunho C.E.

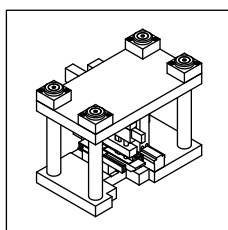

33 96 87 99
Cunho esquadros interior/exterior

Referência	Desenho	Descrição
30 00 95 15		Junta vedação inferior curta
30 92 04 70		Espuma isolante
30 93 00 60		Vedante exterior do vidro (opcional)
30 93 00 61		Junta de vedação exterior
30 93 00 62		Junta exterior plana
30 93 00 65		Junta interior para vidro (5 mm)
30 93 00 66		Junta interior para vidro (4 mm)
30 93 00 67		Junta interior para vidro (2 mm)
30 93 00 68		Junta interior para vidro (6/7 mm)
30 93 00 69		Junta interior para vidro (8/9 mm)
30 93 00 70		Vedante interior do vidro (opcional)
30 93 00 80		Junta de vedação inferior ATi-42
30 93 00 82		Junta de vedação inferior
30 93 00 90		Junta exterior
30 93 01 20		Junta interior
30 93 01 30		Junta exterior (abertura exterior/projectante)
30 93 50 10		Junta central ATi
30 95 00 10		Pelúcia 7x9 mm
30 95 00 40		Pelúcia 7x5.5 mm

Janela 1 folha abrir e oscilo-batente

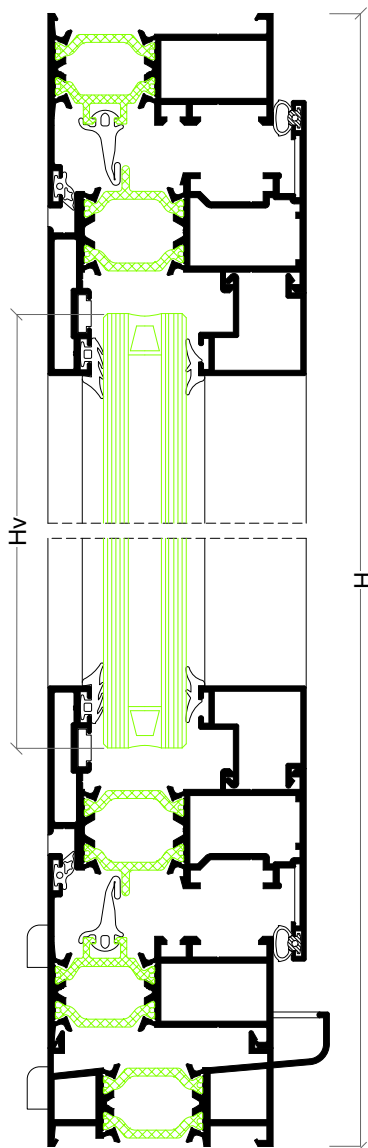
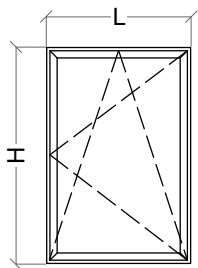

Perfis

Desenho	Ref	Descrição	Corte	Quant	Medida
	ATi-03	Aro fixo		2	L
				2	H-24 mm
	ATi-64	Aro móvel		2	L-42 mm
				2	H-66 mm
	ATi-57	Soleira condensação		1	L
	AX-19	Vareta		1+1	Apro. L+H
	---	Bite		2	L-135 mm
				2	H-199 mm

Acessórios e Juntas

Referência	Descrição	Quantidade	
		Abrir	Oscilo-batente
30 92 00 20	Dobradiças C.E.	2	---
30 92 01 00	Goteiras	4	4
30 92 01 35	Esquadro alinhamento aro móvel	4	4
30 92 02 (xx)	Compasso O.B.	---	1
30 92 02 20	Kit oscilo-batente	---	1
30 92 02 60	Apoio da folha	1	---
30 92 03 10	Kit cremone	1	---
30 92 03 80	Esquadro janela	8	8
30 96 00 12	Jogo topos condensação	1	1
30 96 00 15	Esquadro alinhamento móvel	4	4
30 92 04 70	Espuma isolante	L	L
30 93 00 90	Junta exterior	2L+2H	
30 93 50 10	Junta central	2L+2H	
30 93 01 20	Junta interior	2L+2H	
---	Junta exterior vidro	2L+2H	
---	Junta interior vidro	2L+2H	

51

Vidro

Hv = H-174 mm	Lv = L-149 mm
---------------	---------------

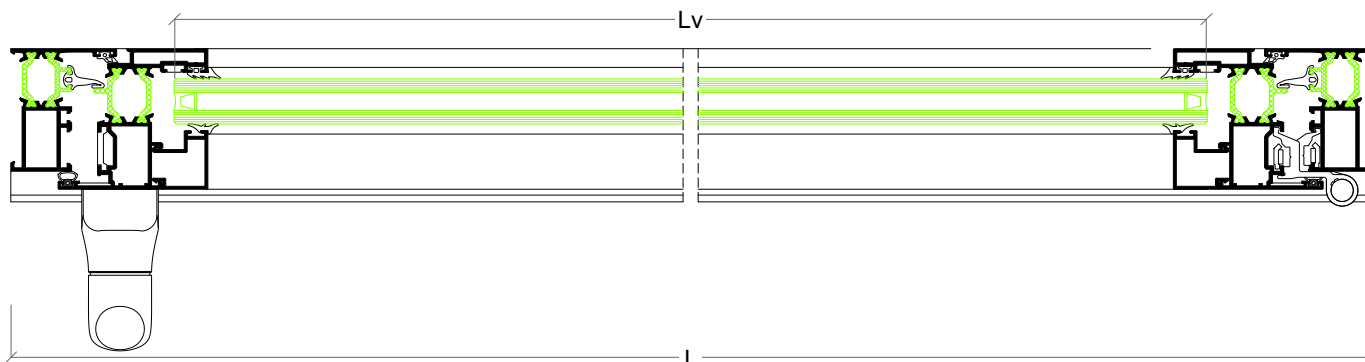

Janela 2 folhas abrir e oscilo-batente

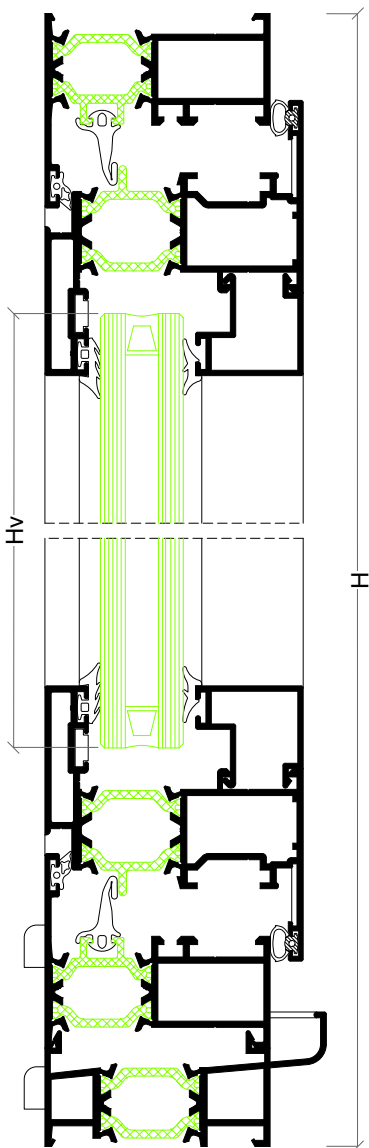
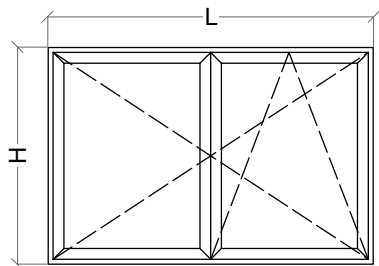

Perfis

Desenho	Ref	Descrição	Corte	Quant	Medida
	ATi-03	Aro fixo		2	L
				2	H-24 mm
	ATi-64	Aro móvel		4	L/2-24 mm
				4	H-66 mm
	ATi-57	Soleira condensação		1	L
	AX-19	Vareta		1+1	Apro. L+H
	---	Bite		4	L/2-117 mm
				4	H-199 mm
	ATi-04	Inversor		1	H-134 mm

Acessórios e Juntas

Referência	Descrição	Quantidade	
		Abriu	Oscilo-batente
30 92 00 20	Dobradiças C.E.	4	---
30 92 01 00	Goteiras	4	4
30 92 01 20	Jogo fecho C.E.	1	---
30 92 01 35	Esquadro alinhamento aro móvel	8	8
30 92 02 (xx)	Compasso O.B.	---	1
30 92 02 20	Kit oscilo-batente	---	1
30 92 02 24	Kit 2ª folha oscilo-batente	---	1
30 92 02 60	Apoio da folha	1	---
30 92 03 10	Kit cremone	1	---
30 92 03 80	Esquadro janela	12	12
30 93 50 21	Jogo topos inversor	1	1
30 96 00 12	Jogo topos condensação	1	1
30 96 00 15	Esquadro alinhamento móvel	8	8
30 92 04 70	Espuma isolante	L	L
30 93 00 90	Junta exterior	2L+4H	
30 93 05 10	Junta central	2L+3H	
30 93 01 20	Junta interior	2L+4H	
---	Junta exterior vidro	2L+4H	
---	Junta interior vidro	2L+4H	

Vidro

Hv = H-174 mm	Lv = L/2-131 mm
---------------	-----------------

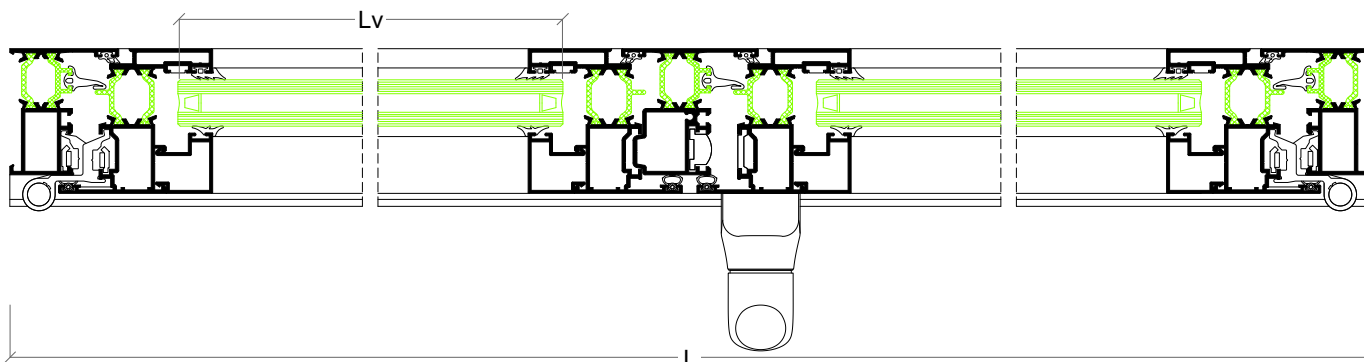

Porta 1 folha

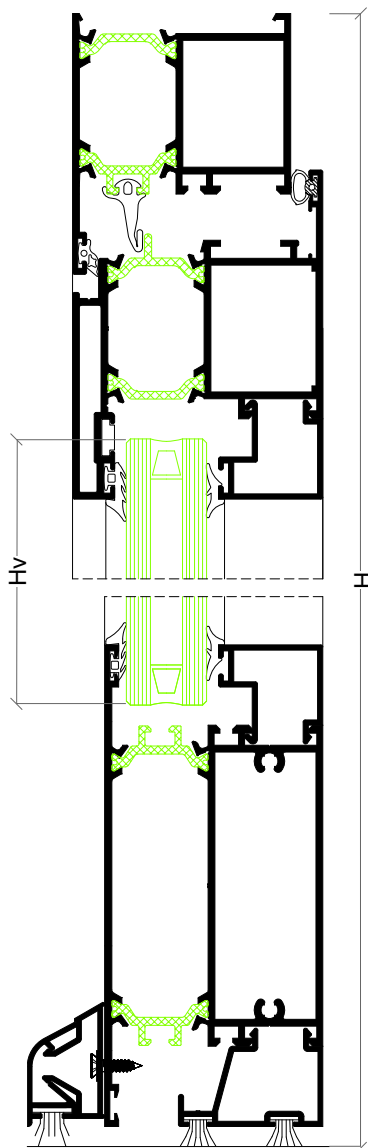
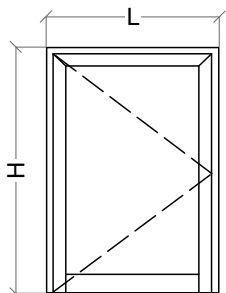

Perfis

Desenho	Ref	Descrição	Corte	Quant	Medida
	ATi-08	Aro fixo		1	L
				2	H
	ATi-65	Aro móvel		1	L-78 mm
				2	H-44 mm
	ATi-12	Travessa		1	L-193 mm
	AX-15	Bite remate		1	L-202 mm
	---	Bite		2	L-202 mm
				2	H-246 mm
	AZ-60	Pingadeira		1	L-145 mm
	AZ-61	Clip pingadeira		1	L-242 mm

Acessórios e Juntas

Referência	Descrição	Quantidade
30 92 00 20	Dobradiças C.E.	3
30 92 03 90	Esquadro porta	4
30 92 05 10	Fechadura 3 pontos	1
30 92 05 52	Canhão fechadura	1
30 92 05 60	Puxador duplo	1
30 96 00 15	Esquadro alinhamento móvel	2
30 92 05 00	Jogo topos	1
30 96 00 28	Esquadro alinhamento	2
30 93 00 90	Junta exterior	1L+2H
30 93 05 10	Junta central	1L+2H
30 93 01 20	Junta interior	1L+2H
30 95 00 10	Pelúcia 7x9 mm	2L
---	Junta exterior vidro	2L+2H
---	Junta interior vidro	2L+2H

53

Vidro

Hv = H-220 mm	Lv = L-216 mm
---------------	---------------

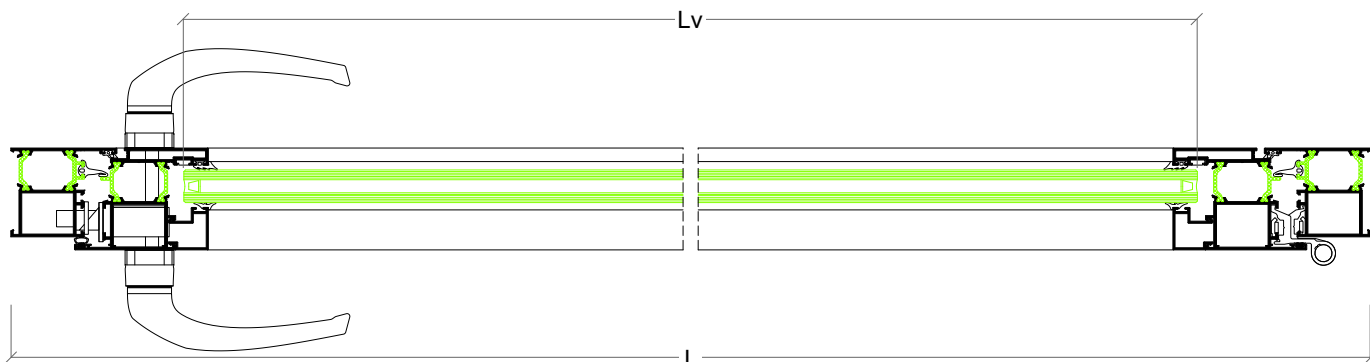

Porta 2 folhas

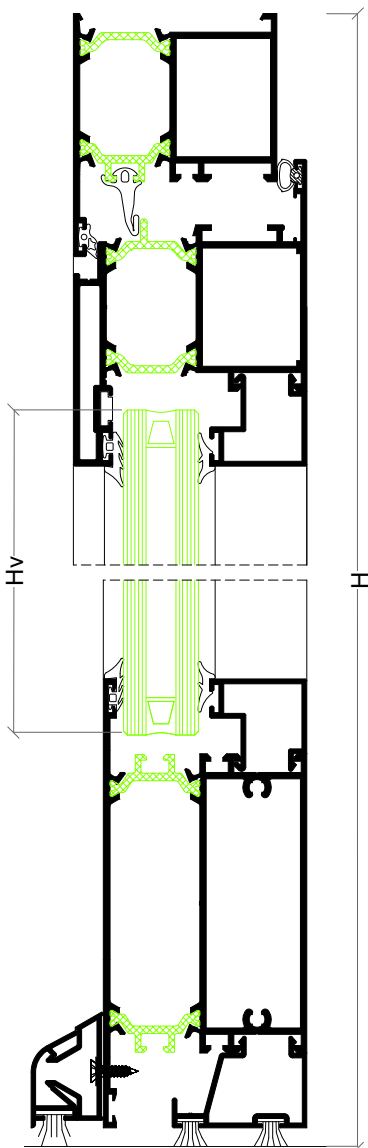
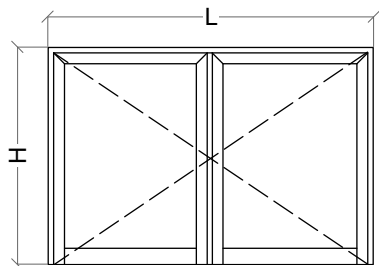

Perfis

Desenho	Ref	Descrição	Corte	Quant	Medida
	ATi-08	Aro fixo		1	L
				4	H
	ATi-65	Aro móvel		2	L/2-42 mm
				4	H-44 mm
	ATi-04	Inversor		1	H-78 mm
	ATi-12	Travessa		2	L/2-157 mm
	AX-15	Bite remate		2	L/2-166 mm
	---	Bite		4	L/2-166 mm
				4	H-246 mm
	AZ-60	Pingadeira		1	Aprox. L/2
				1	Aprox. L/2
	AZ-61	Clip pingadeira		2	L/2-206 mm

Acessórios e Juntas

Referência	Descrição	Quantidade
30 92 00 20	Dobradiças C.E.	6
30 92 01 12	Jogo topos inversor	1
30 92 01 20	Jogo fecho C.E.	1
30 92 03 90	Esquadro porta	6
30 92 05 10	Fechadura 3 pontos	1
30 92 05 52	Canhão fechadura	1
30 92 05 60	Puxador duplo	1
30 96 00 15	Esquadro alinhamento móvel	4
30 92 05 00	Jogo topos	1
30 96 00 28	Esquadro alinhamento	2
30 93 00 90	Junta exterior	1L+4H
30 93 05 10	Junta central	1L+3H
30 93 01 20	Junta interior	L+4H
30 95 00 10	Pelúcia 7x9 mm	2L
---	Junta exterior vidro	2L+2H
---	Junta interior vidro	2L+2H

Vidro

Hv = H-220 mm	Lv = L-180 mm
---------------	---------------

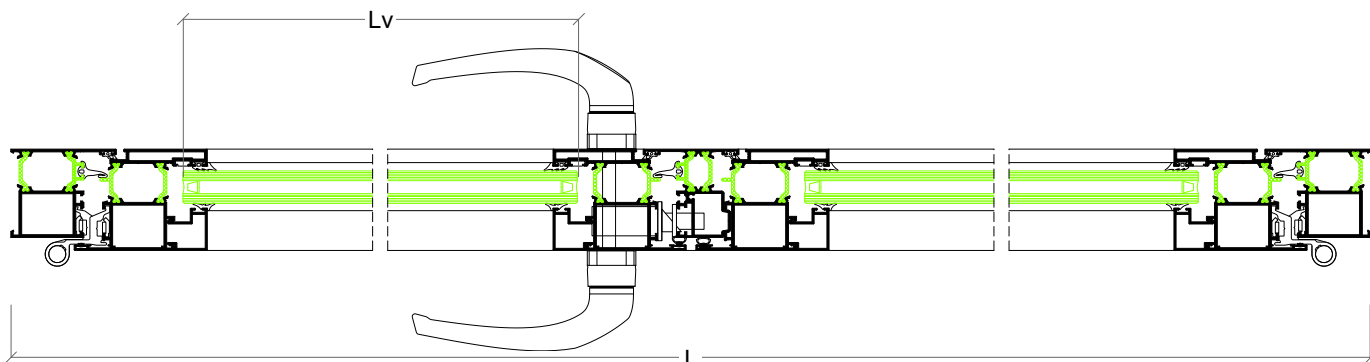

Porta oscilo-paralela com fixo lateral

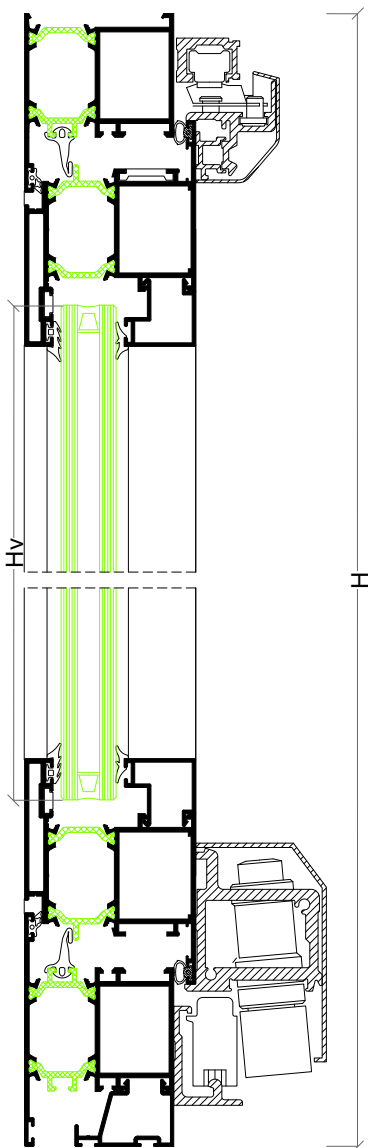
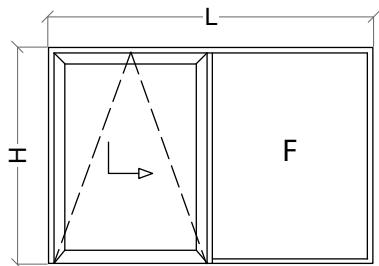

Perfis

Desenho	Ref	Descrição	Corte	Quant	Medida
	ATi-08	Aro fixo		1	L
				2	H
	ATi-65	Aro móvel		2	L1-56 mm
				2	H-98 mm
	ATi-06	Travessa		1	L-81 mm
				1	H-101mm
	AX-15	Bite remate		1	L-90 mm
	AX-19	Vareta		1+1	Apro. L+H
	---	Bite (folha)		2	L1-180 mm
				2	H-262 mm
	---	Bite (fixo)		2	L2-67.5 mm
				2	H-150 mm

Acessórios e Juntas

Referência	Descrição	Quantidade
30 92 01 00	Goteiras	4
30 92 01 50	União topos porta	2
30 92 03 90	Esquadro porta	6
30 96 00 15	Esquadro alinhamento móvel	4
---	Kit oscilo-paralela	1
30 96 00 28	Esquadro alinhamento	4
30 93 00 90	Junta exterior	2L1+2H
30 93 05 10	Junta central	2L1+2H
30 93 01 20	Junta interior	2L1+2H
---	Junta exterior vidro	2L+2H
---	Junta interior vidro	2L+2H

	Mínimo	Máximo
Largura da folha	700 mm	1650 mm
Altura da folha	850 mm	2400 mm
Peso máximo por folha 150 kg		

Vidro

Hv folha = H-236 mm	Lv folha = L1-193 mm
Hv fixo = H-124 mm	Lv fixo = L2-81 mm

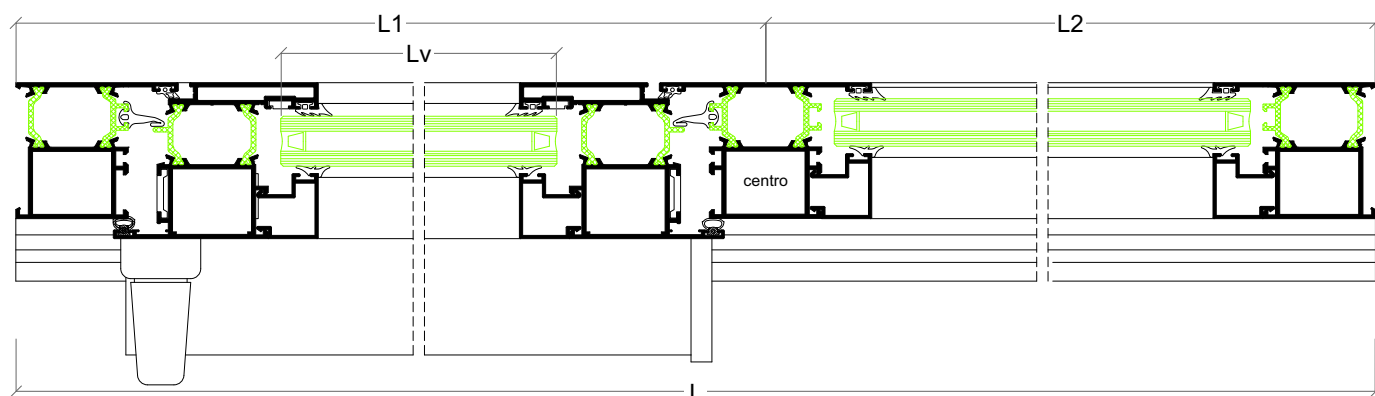

Porta 3 folhas harmónio

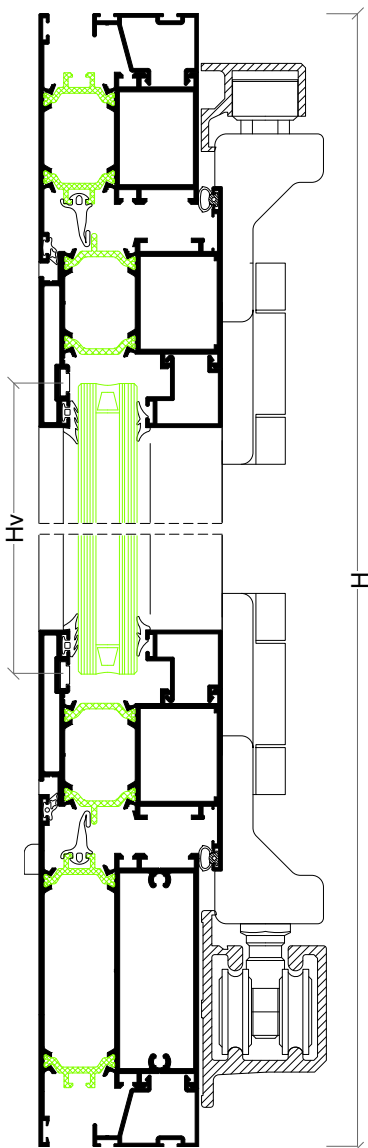
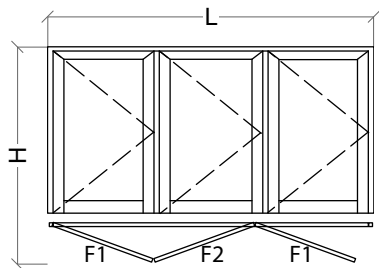

Perfis

Desenho	Ref	Descrição	Corte	Quant	Medida
	ATi-08	Aro fixo		2	H
	ATi-06	Travessa		1	L-81 mm
	AXi-12	Travessa		1	L-81
	ATi-65	Aro móvel		6	(consultar)
				6	(consultar)
	ATi-04	Inversor		2	(consultar)
	AX-15	Bite remate		2	L-90 mm
	AX-19	Vareta		2	2H
	---	Bite		6	(consultar)
				6	(consultar)

Acessórios e Juntas

Referência	Descrição	Quantidade
30 92 01 50	União topo porta	2
30 92 01 00	Goteiras	6
30 93 50 21	Jogo topos inversor	2
30 92 03 90	Esquadro porta	12
---	Kit harmónio (3+0)	1
30 92 01 20	Jogo fecho C.E.	1
30 96 00 28	Esquadro alinhamento	12
30 96 00 15	Esquadro móvel exterior	12
30 93 00 90	Junta exterior	2L+6H
30 93 05 10	Junta central	2L+4H
30 93 01 20	Junta interior	2L+6H
---	Junta exterior vidro	2L+6H
---	Junta interior vidro	2L+6H

	Mínimo	Máximo
Largura da folha	600 mm	900 mm
Altura da folha	850 mm	2400 mm
Peso máximo por folha 80 kg		

Vidro

Hv = consultar	Lv F1 = consultar
	Lv F2 = consultar

