



**Sistema**

**XP**

## **Sistema XP**

### Sistema de Portadas

#### **Características do sistema**

Sistema de portada que oferece a possibilidade de dois tipos de lâminas:

- Lâminas fixas
- Lâminas orientáveis

As lâminas orientáveis permitem uma total regulação através de mecanismos de rotação que permitem assim um controle da luminosidade de interior.

Este sistema não utiliza inversores graças à fisionomia da folha, utilizando apenas um pequeno perfil de batente.

#### **Perfis de alumínio**

As secções do aro e do móvel são de 40 e 47 mm respectivamente, com uma espessura média dos perfis de alumínio de 1.5 mm.

#### **Dimensionamento e manobralidade**

Possibilidades de abertura: exterior (1, 2, 3 e 4 folhas), harmónio e correr.

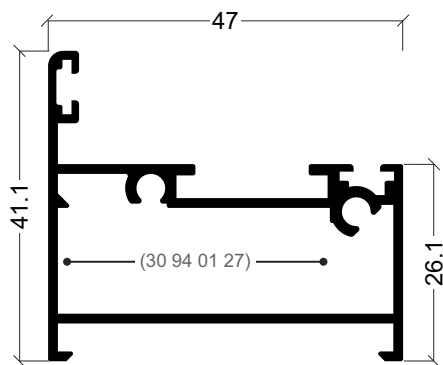

**XP-03**  
Aro fixo

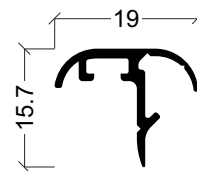

**XP-04**  
Perfil de batente

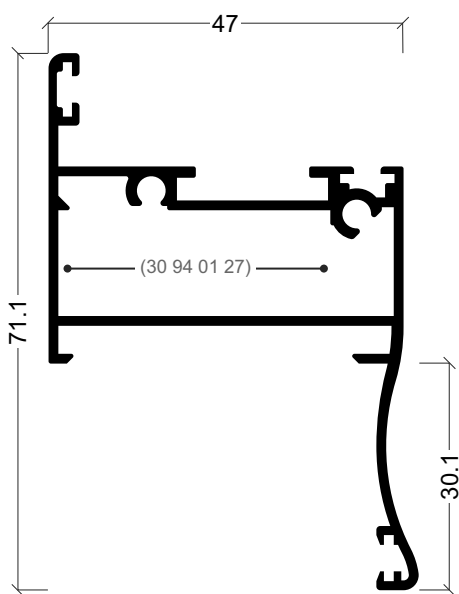

**XP-09**  
Aro fixo com remate

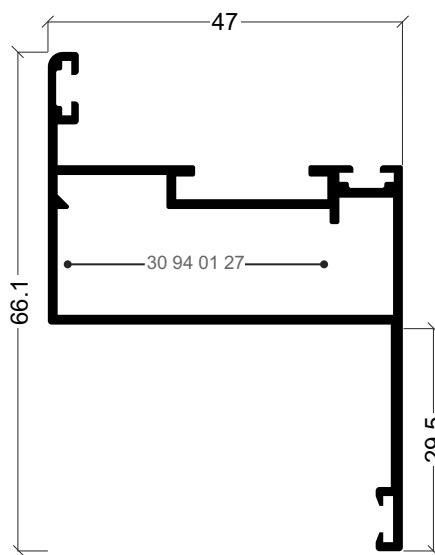

**XP-26**  
Aro fixo com remate

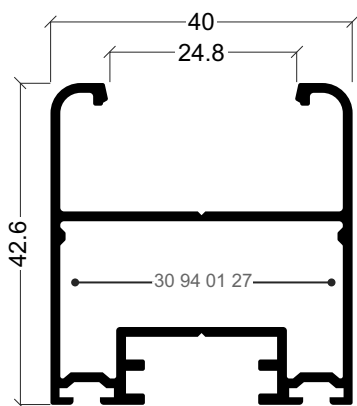

**XP-05**  
Aro móvel

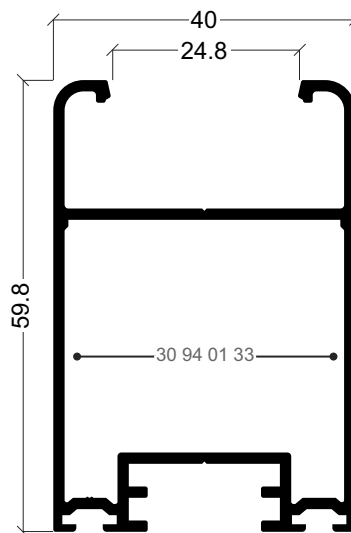

**XP-18**  
Aro móvel

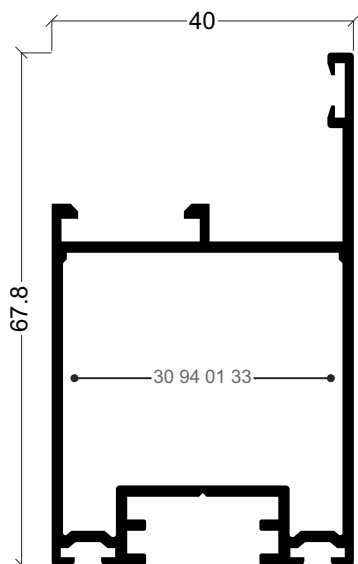

**XP-22**  
Aro móvel com bite

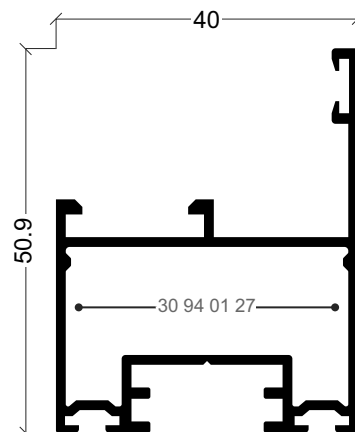

**XP-11**  
Aro móvel com bite

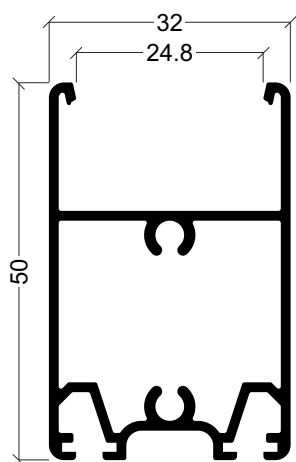

**XP-10**  
Almofada 50 mm

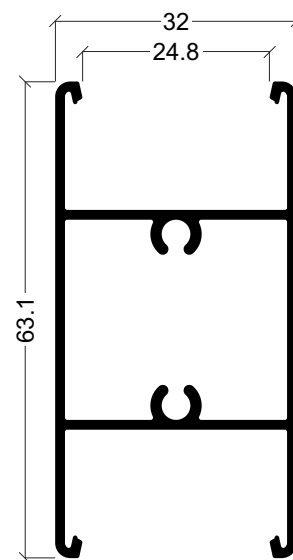

**XP-25**  
Travessa 63 mm

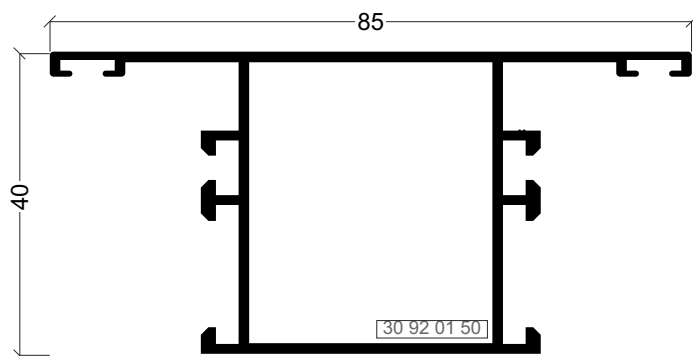

**AZ-09**  
Travessa

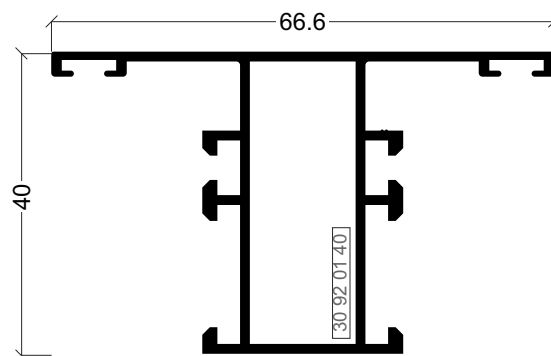

**AZ-01**  
Travessa

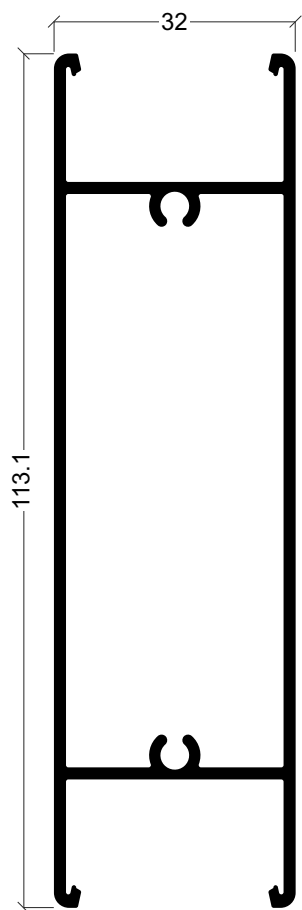

**XP-27**  
Travessa 113 mm

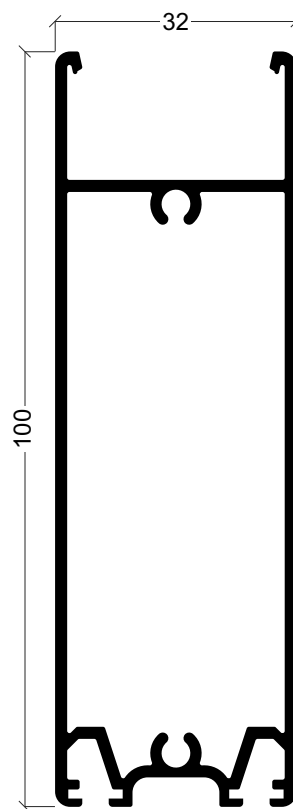

**XP-16**  
Almofada 100 mm

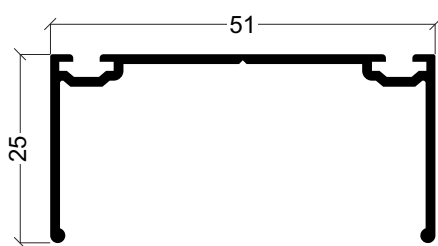

**XP-20**  
Distanciador aro fixo de correr

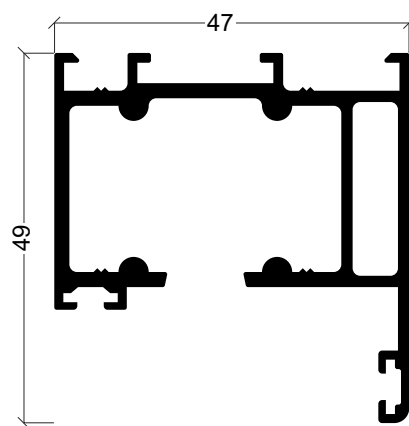

**XP-21**  
Aro fixo de correr

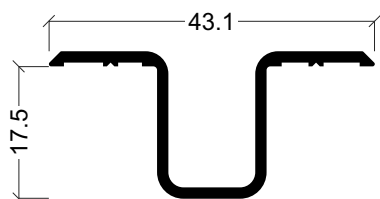

**XP-23**  
Guia embutir de correr

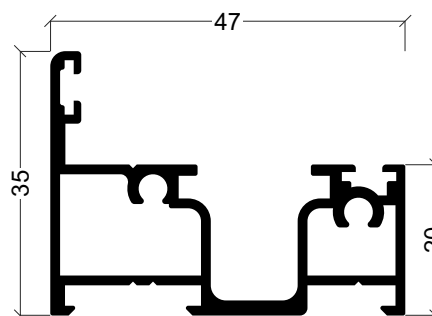

**XP-24**  
Aro fixo guia de correr

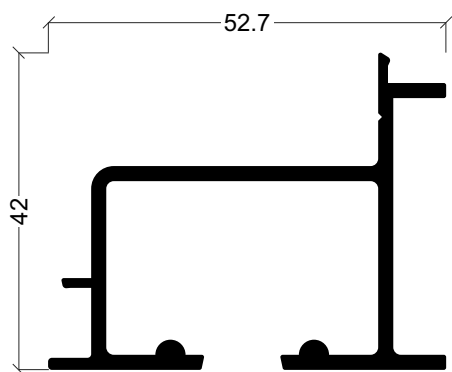

**XP-07**  
Guia superior de correr

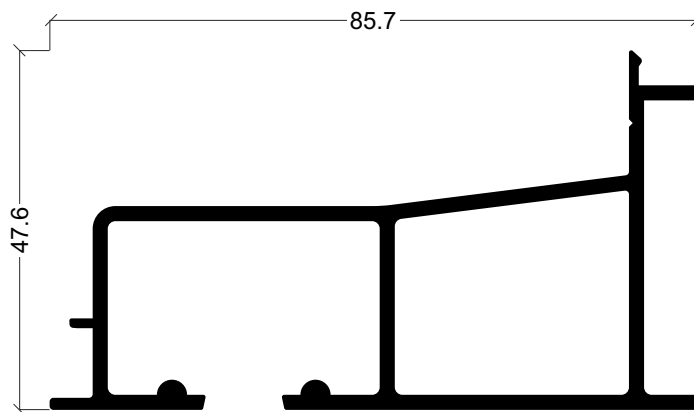

**XP-13**  
Guia superior de correr

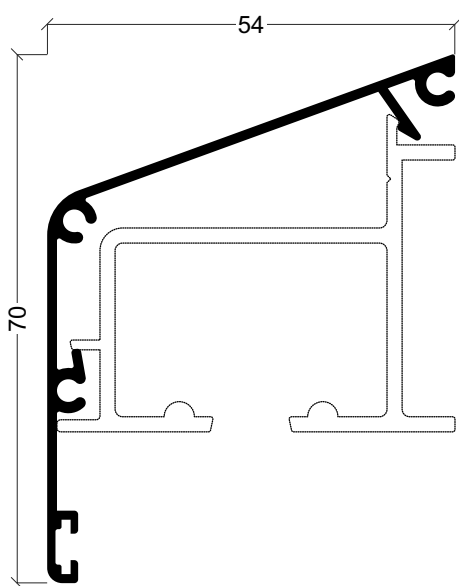

**XP-06**  
Tampa guia superior de correr

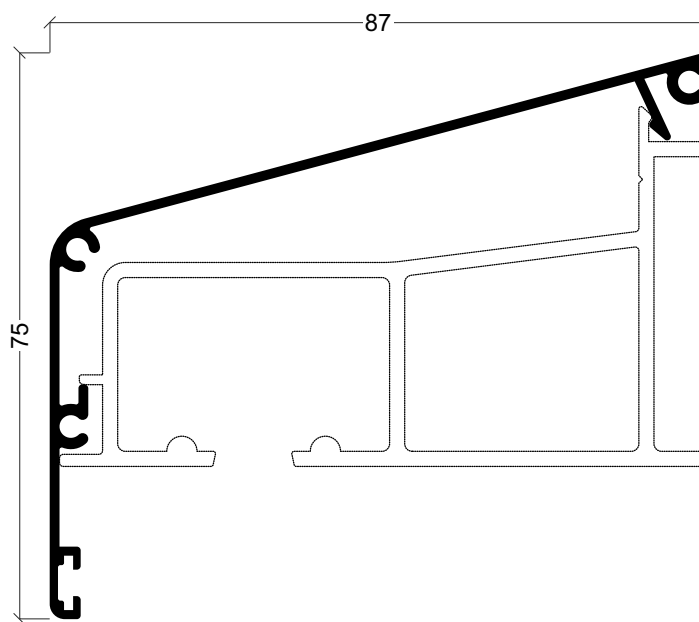

**XP-12**  
Tampa guia superior de correr longa

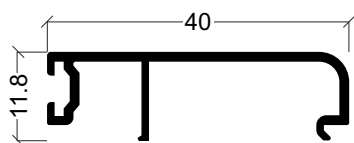

**XP-08**  
Tampa lateral de correr

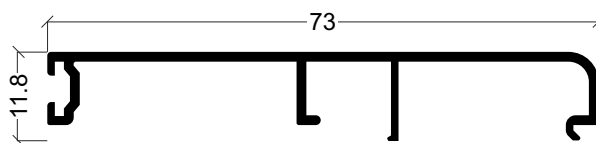

**XP-14**  
Tampa lateral de correr larga

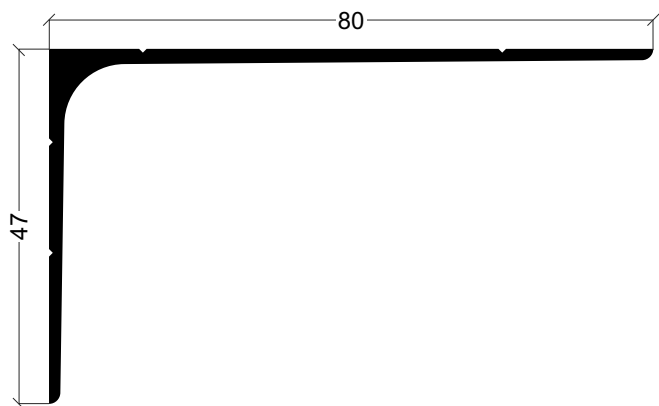

**XP-15**  
Guia inferior de correr

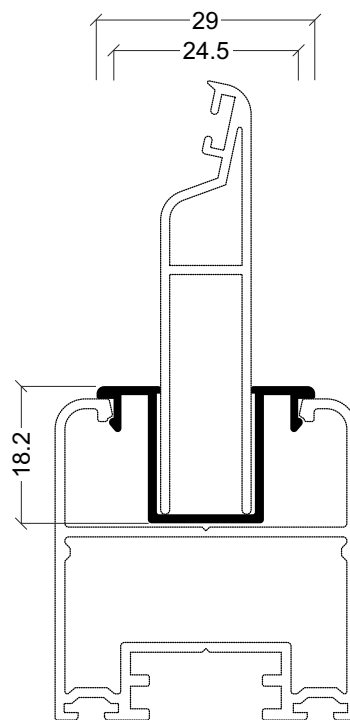

**XP-19**  
Redutor para Z/54

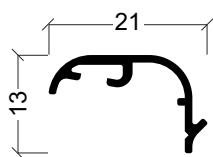

**XP-17**  
Perfil batente de correr

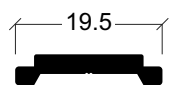

**AX-19**  
Vareta

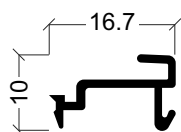

**AX-33**  
Mola Bite

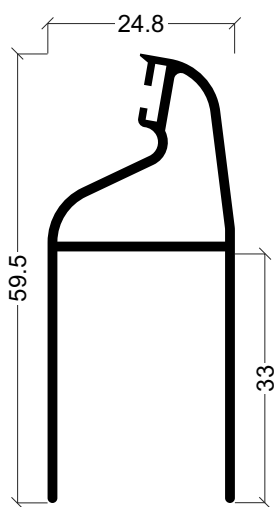

**XP-01**  
Meia lâmina 33 mm

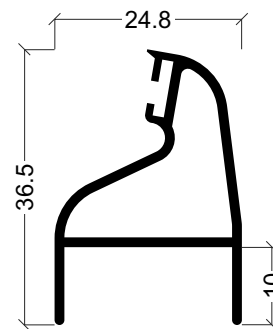

**XP-02**  
Meia lâmina 10 mm

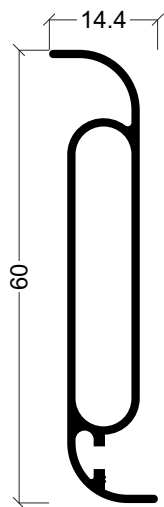

**Z-52**  
Lâmina móvel

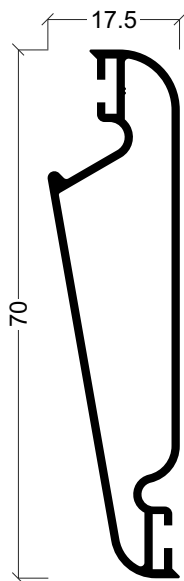

**Z-53**  
Lâmina móvel

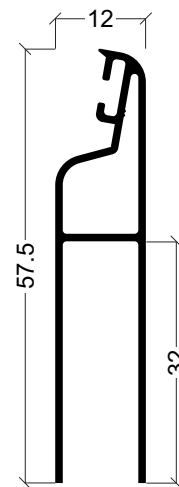

**Z-54**  
Meia lâmina 32 mm

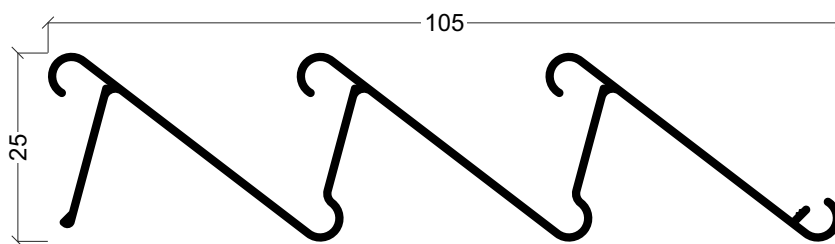

**Z-20**  
Meia lâmina

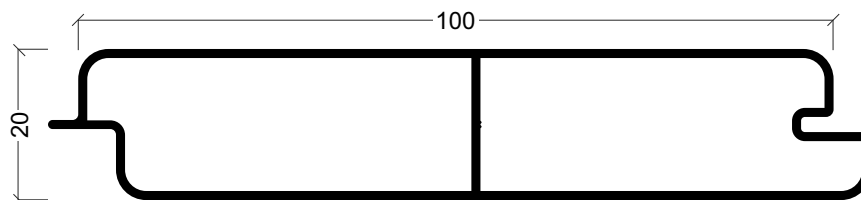

**W-25**  
Lâmina de encaixe 100 x 20



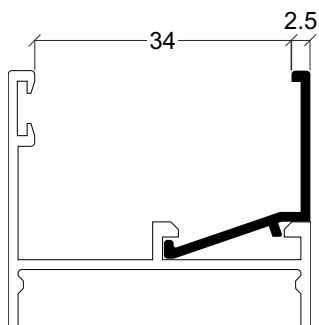

**AX-69**

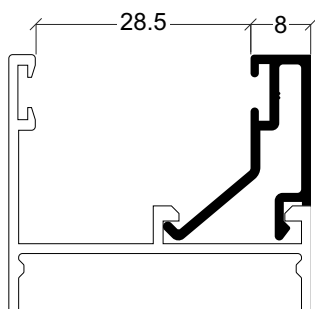

**AX-74**

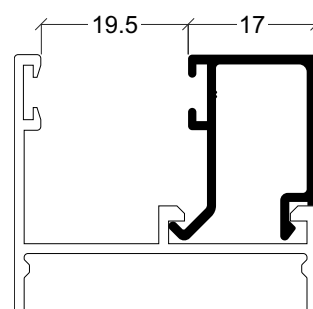

**AX-46**

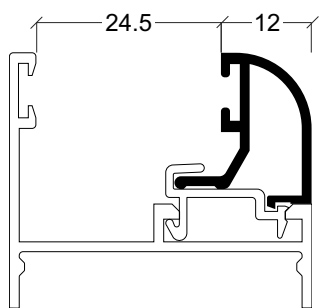

**AX-37**

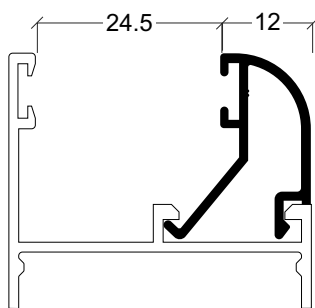

**AZ-8**

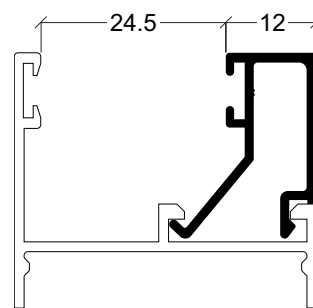

**AX-36**

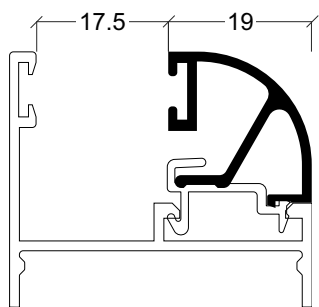

**AX-30**

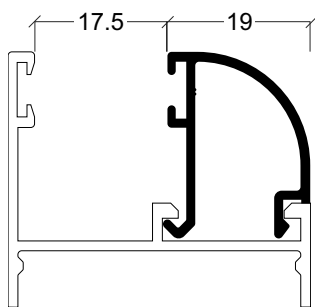

**AZ-7**

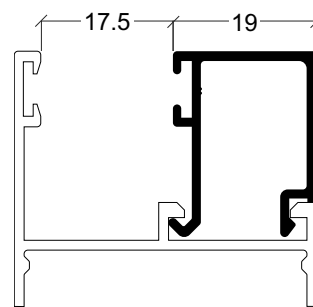

**AX-35**

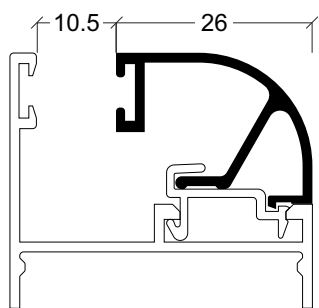

**AX-29**

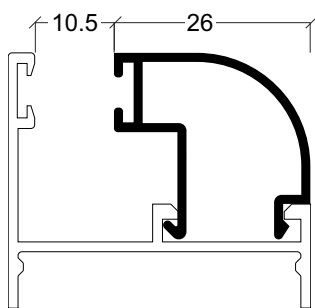

**AZ-6**

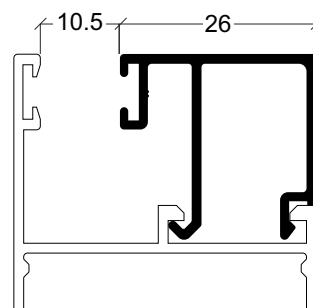

**AX-31**

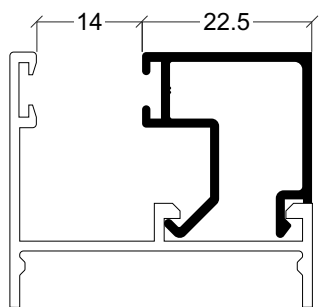

**AX-78**

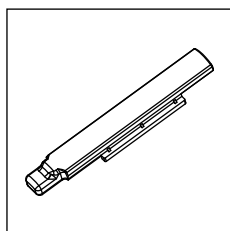

**30 92 00 41**

Terminal superior

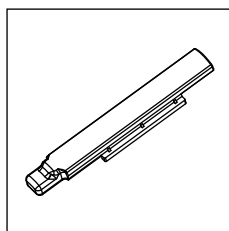

**30 92 00 42**

Terminal inferior

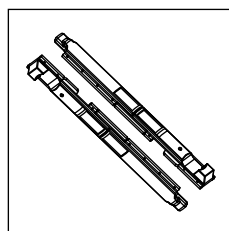

**30 92 01 20**

Fecho 2ª folha

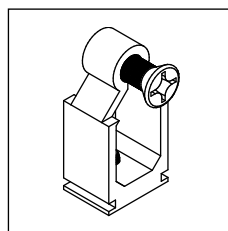

**30 92 01 40**

União topos janela

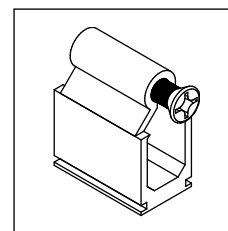

**30 92 01 50**

União topos porta

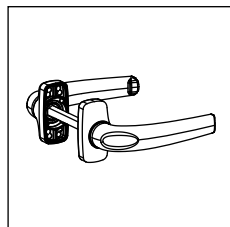

**30 92 05 60**

Puxador duplo

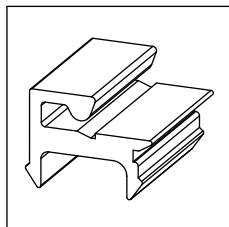

**30 94 01 01**

Mola bite plástica

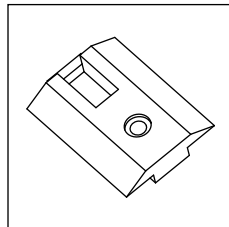

**30 94 01 02**

Complemento de fecho

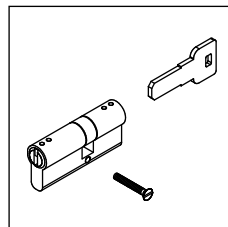

**30 94 01 03**

Canhão 30x30

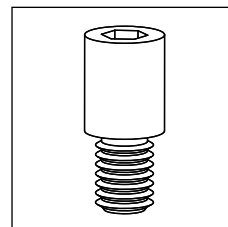

**30 94 01 04**

Jogo parafusos  
distanciadores

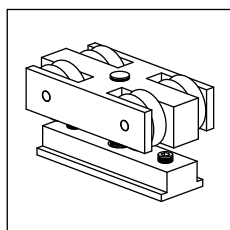

**30 94 01 05**

Rolamentos

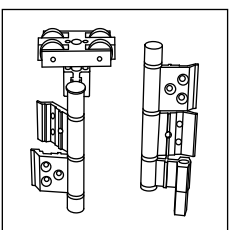

**30 94 01 06/14**

Rolamento e dobradiça  
harmónio (branco/preto)

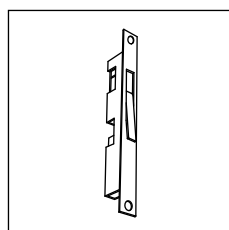

**30 94 01 07/15**

Fecho de embutir  
(branco/preto)

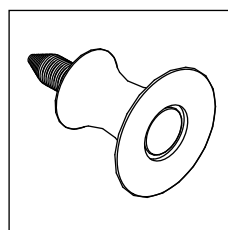

**30 94 01 08/16**

Aplique fixador (branco/  
preto)

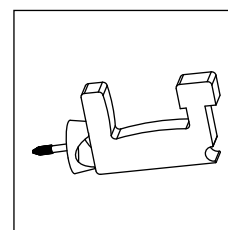

**30 94 01 09/17**

Fixador de portada 2  
folhas (branco/preto)

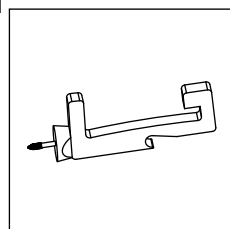

**30 94 01 10/18**

Fixador portada 4 folhas  
(branco/preto)

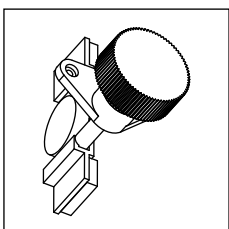

**30 94 01 11/19**

Comando lâminas  
orientáveis (branco/preto)

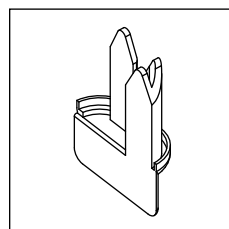

**30 94 01 12/20**

Jogo topos perfil batente  
(branco/preto)

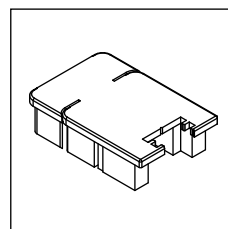

**30 94 01 13/21**

Tampa aro móvel  
(branco/preto)

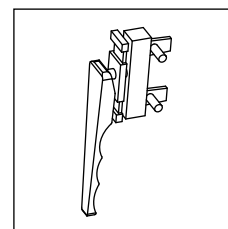

**30 94 01 23/29 - 30 94 02 23/29**

Cremona 4ª folha direito (branco/  
preto) - esquerdo (branco/preto)

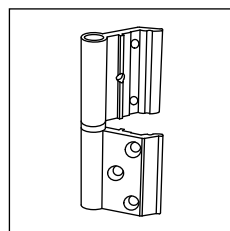

**30 94 01 24/30**

Dobradiça (branco/preto)

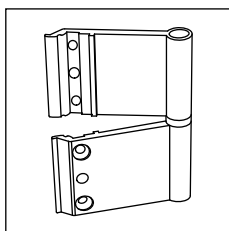

**30 94 01 25/31**

Dobradiça 4ª folha  
(branco/preto)

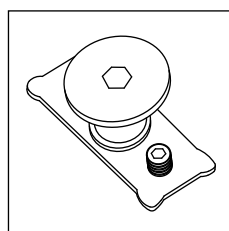

**30 94 01 26**

Distanciador aro

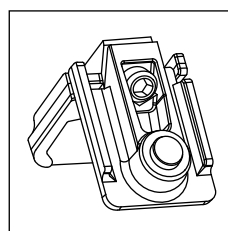

**30 94 01 27**

Esquadro janela

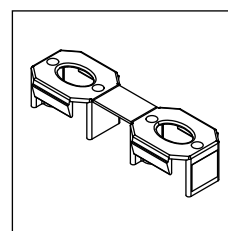

**30 94 01 32**

Distanciador travessa

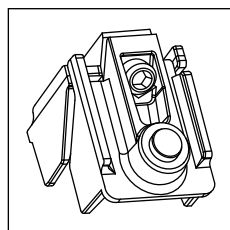

**30 94 01 33**

Esquadro porta

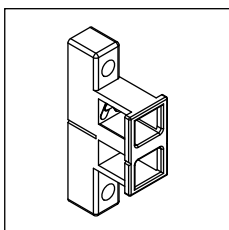

**30 94 01 34**

Fecho superior correr

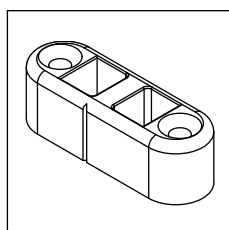

**30 94 01 35**

Fecho inferior correr

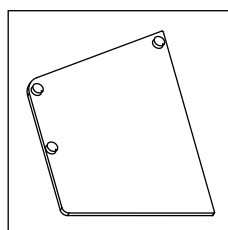

**30 94 01 36**

Tampa lateral correr  
54 mm

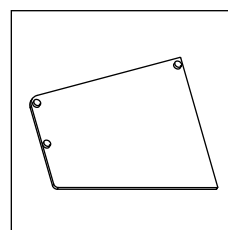

**30 94 01 37**

Tampa lateral correr  
87 mm

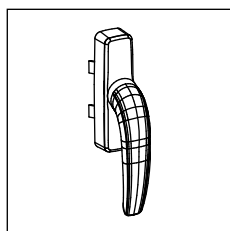

**30 94 01 38**

Cremona abertura exterior

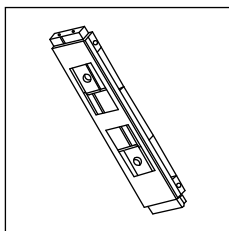

**30 94 01 39**

Kit fixação cremone abertura exterior

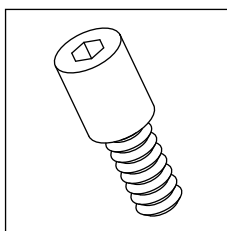

**30 94 01 40**

Distanciador abertura exterior 14 mm

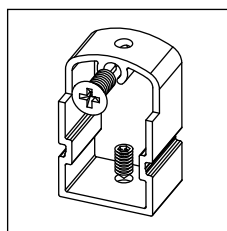

**30 94 01 42**

Topo travessa XP-10

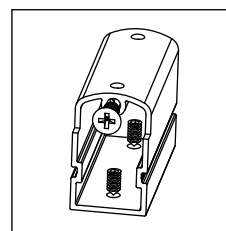

**30 94 01 43**

Topo travessa XP-16

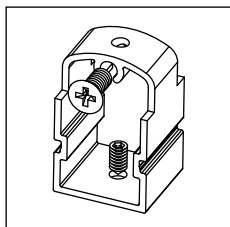

**30 94 01 44**

União topos janela

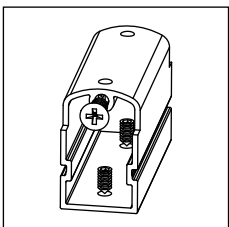

**30 94 01 45**







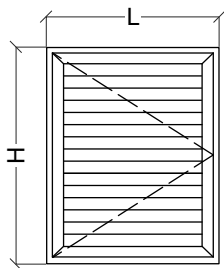

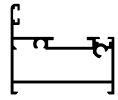

Topo travessa XP-27

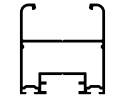
Referência	Desenho	Descrição
30 93 01 40		Junta lâminas
30 94 01 46		Junta interior/exterior
30 95 00 10		Pelúcia 7x9 mm
30 95 00 30		Pelúcia 7x7 mm

## Janela 1 folha abertura exterior

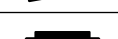

### Perfis

Desenho	Ref	Descrição	Corte	Quant	Medida
	XP-03	Aro fixo		1	L
				2	H
	XP-05	Aro móvel de janela		2	L-64 mm
				2	H-37 mm
	XP-01	Meia lâmina		2	L-173 mm
	Z-53	Lâmina		Segundo altura	L-163 mm
	AX-19	Vareta		2	Apro. H/2 mm

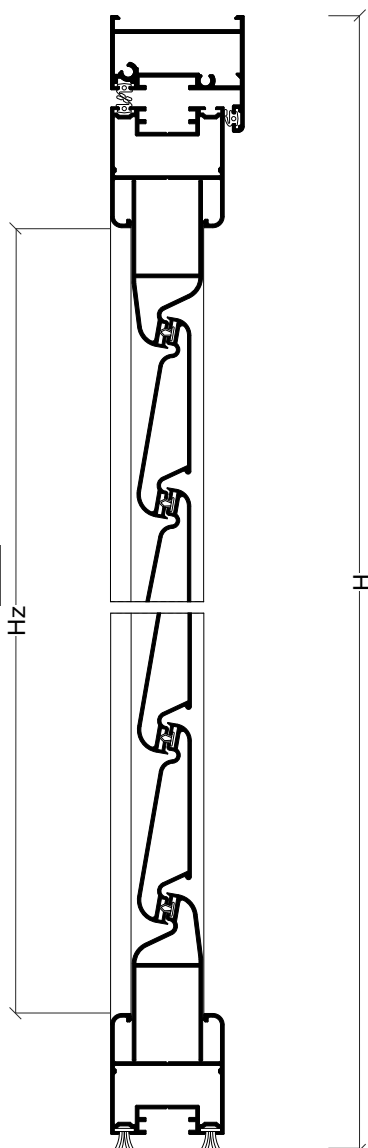

### Acessórios e Juntas

Referência	Descrição	Quantidade
30 94 01 02	Complemento fecho de portada	2
30 94 01 09	Fixador de portada	1
30 94 01 24	Dobradiça branca	2
30 94 01 27	Esquadro de janela	6
30 92 00 41	Terminal de fecho	2
30 94 01 38	Cremone abertura exterior	1
30 94 01 39	Kit fixação cremone	1
30 94 01 40	Distanciador 14 mm abertura exterior	2
---	Jogo portalâminas (segundo altura)	1
30 93 01 40	Vedante lâminas	Nº lâminas + 1L
30 94 01 46	Junta interior/exterior	3L+6H
30 95 00 30	Pelúcia 7x7 mm	2L

### Portalâminas

Hz = H-122 mm
---------------

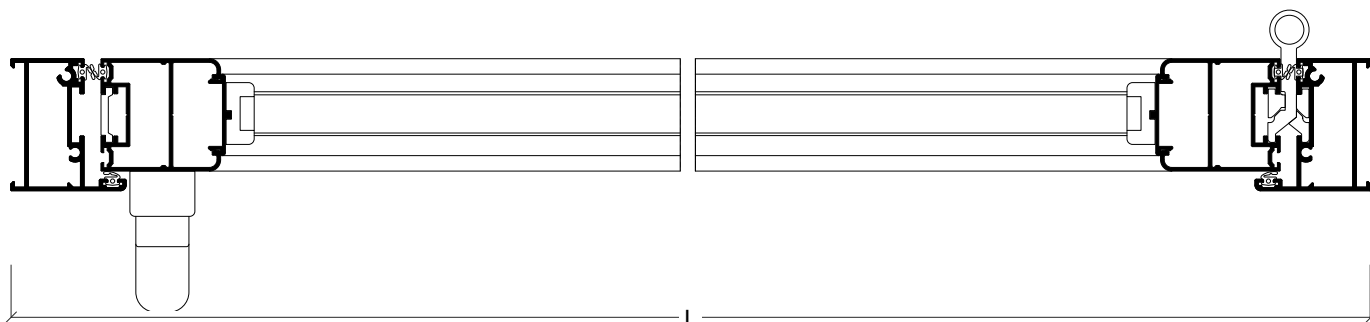

## Janela 1 folha abertura exterior - lâminas fixas

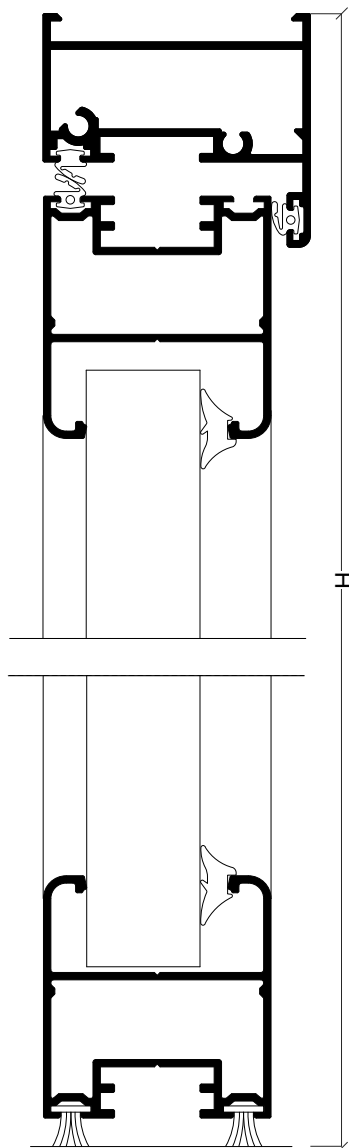
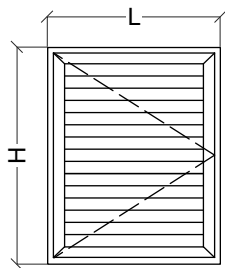

### Perfis

Desenho	Ref	Descrição	Corte	Quant	Medida
	XP-03	Aro fixo		1	L
				2	H
	XP-05	Aro móvel de janela		2	L-64 mm
				2	H-37 mm
	W-25	Lâmina		Segundo altura	H-93 mm
	AX-19	Vareta		2	Apro. H/2 mm

### Acessórios e Juntas

Referência	Descrição	Quantidade
30 94 01 02	Complemento fecho de portada	2
30 94 01 09	Fixador de portada	1
30 94 01 24	Dobradiça branca	2
30 94 01 27	Esquadro de janela	6
30 92 00 40	Terminal de fecho	2
30 94 01 38	Cremone abertura exterior	1
30 94 01 39	Kit fixação cremone	1
30 94 01 40	Distanciador 14 mm abertura exterior	2
30 94 01 46	Junta interior/exterior	3L+6H
30 95 00 30	Pelúcia 7x7 mm	2L
30 93 00 65	Junta de cunha	2L+2H



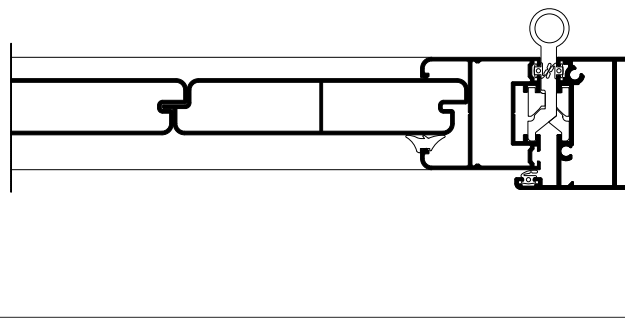
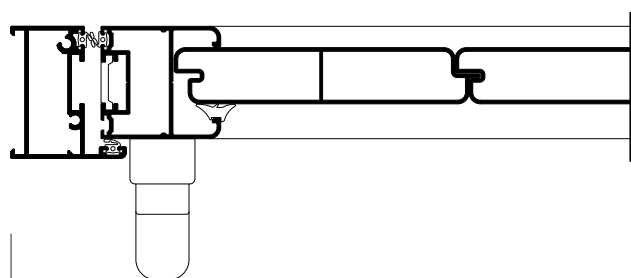



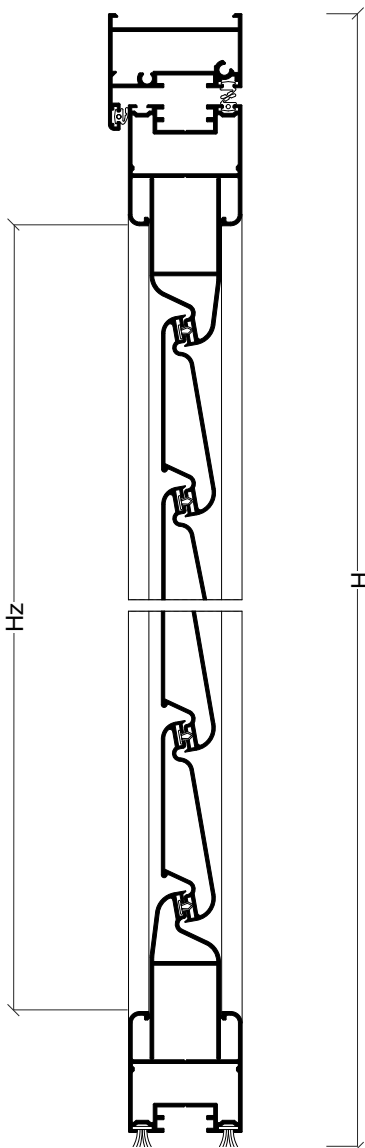
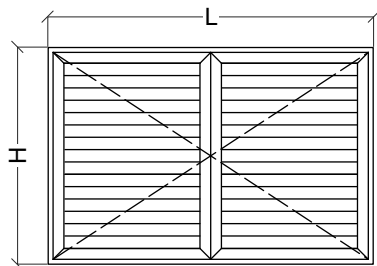



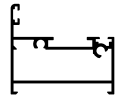



201



## Janela 2 folhas abertura exterior



### Perfis

Desenho	Ref	Descrição	Corte	Quant	Medida
	XP-03	Aro fixo		1	L
				2	H
	XP-05	Aro móvel de janela		4	L/2-37 mm
				4	H-37 mm
	XP-01	Meia lâmina		4	L/2-144 mm
	Z-53	Lâmina		Segundo altura	L/2-134 mm
	XP-04	Perfil de batente		2	H-37 mm
	AX-19	Vareta		2	Apro. H/2 mm

### Acessórios e Juntas

Referência	Descrição	Quantidade
30 92 00 41	Terminal de fecho	2
30 94 01 02	Complemento fecho de portada	2
30 92 01 20	Fecho 2ª folha	2
30 94 01 09	Fixador de portada	2
30 94 01 12	Jogo topos para perfil batente	2
30 94 01 24	Dobradiça	4
30 94 01 27	Esquadro de janela	10
30 94 01 38	Cremone abertura exterior	1
30 94 01 39	Kit fixação cremone	1
30 94 01 40	Distanciador 14 mm abertura exterior	2
---	Jogo portalâminas (segundo altura)	1
30 93 01 40	Vedante lâminas	Nº lâminas + 1 L/2
30 94 01 46	Junta interior/exterior	2L+2L/2+8H
30 95 00 30	Pelúcia 7x7 mm	4L/2

### Portalâminas

Hz = H-122 mm
---------------

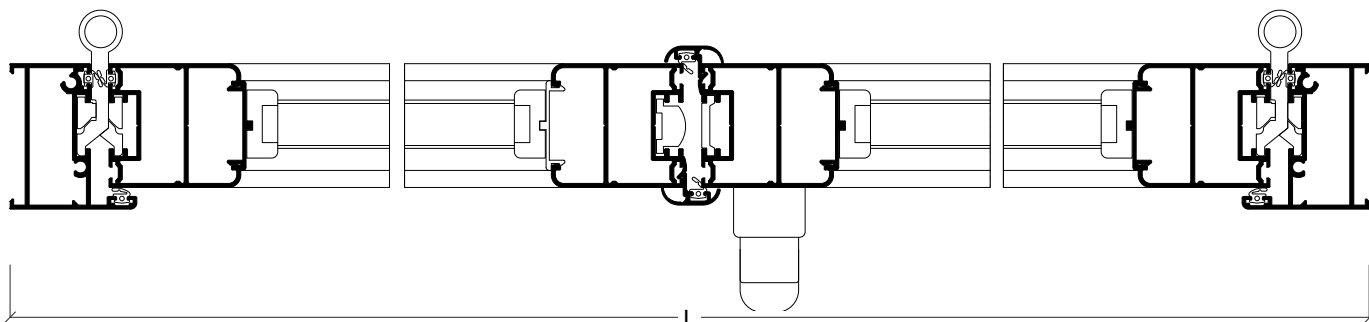

## Janela 3 folhas abertura exterior

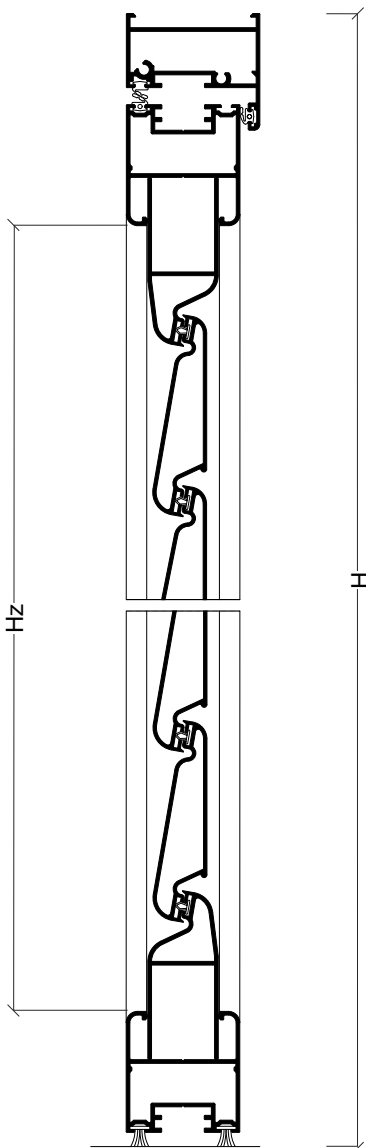
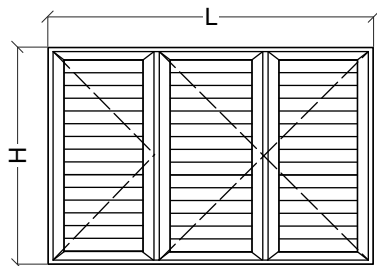

### Perfis

Desenho	Ref	Descrição	Corte	Quant	Medida
	XP-03	Aro fixo		1	L
				2	H
	XP-05	Aro móvel de janela		4	Lat. = L/2-37 mm
				2	Cen. = L/3-42 mm
				6	H-37 mm
	XP-01	Meia lâmina		4	Lat. = L/3-126 mm
				2	Cen. = L/3-151 mm
	Z-53	Lâmina		Segundo altura	Lat. = L/3-116 mm
				Segundo altura	Cen. = L/3-141 mm
	XP-04	Perfil de batente		2	H-37 mm
	AX-19	Vareta		2	Apro. H/2 mm

### Acessórios e Juntas

Referência	Descrição	Quantidade
30 92 00 41	Terminal de fecho	2
30 94 01 02	Complemento fecho de portada	4
30 92 01 20	Fecho 2ª folha	4
30 94 01 09	Fixador de portada (opcional)	1
30 94 01 10	Fixador de portada 3/4 folhas (opcional)	1
30 94 01 12	Jogo topos para perfil batente	3
30 94 01 24	Dobradiça	4
30 94 01 25	Dobradiça 3ª/4ª folha	2
30 94 01 27	Esquadro de janela	14
30 94 01 38	Cremone abertura exterior	1
30 94 01 39	Kit fixação cremone	1
30 94 01 40	Distanciador 14 mm abertura exterior	2
---	Jogo portalâminas (segundo altura)	3
30 93 01 40	Vedante lâminas	Nº lâminas + 1 L/3
30 94 01 46	Junta interior/exterior	2L+3L/3+11H
30 95 00 30	Pelúcia 7x7 mm	6L/2

203

### Portalâminas

Hz = H-122 mm
---------------

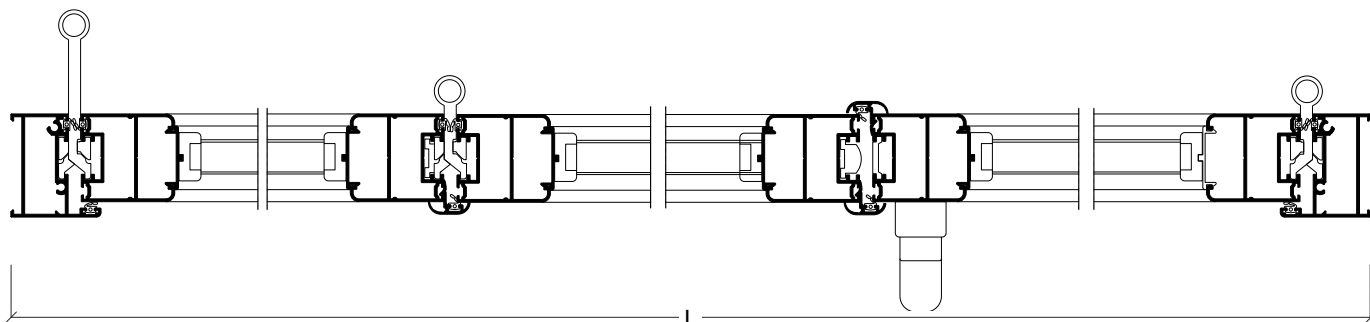

## Janela 4 folhas abertura exterior

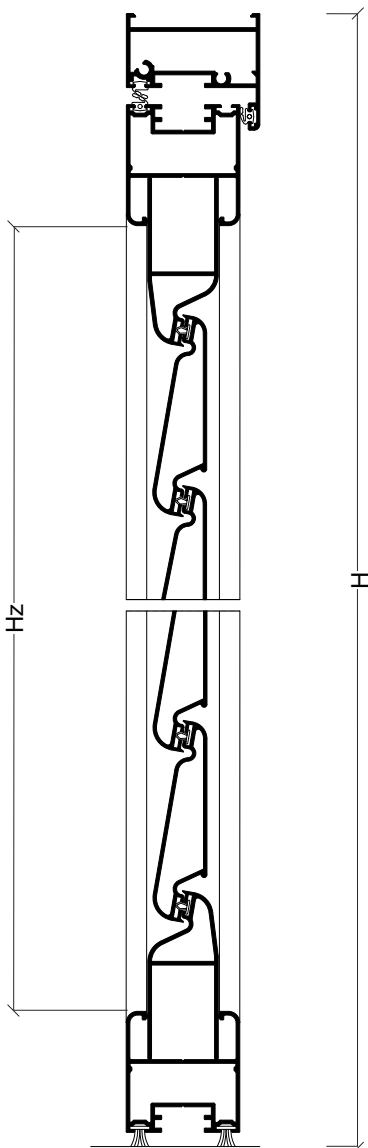
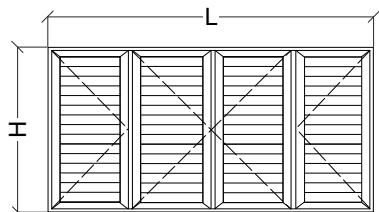

### Perfis

Desenho	Ref	Descrição	Corte	Quant	Medida
	XP-03	Aro fixo		1	L
				2	H
	XP-05	Aro móvel de janela		4	Lat. = L/4-8 mm
				4	Cen. = L/4-33 mm
				8	H-37 mm
	XP-01	Meia lâmina		4	Lat. = L/4-117 mm
				4	Cen. = L/4-132 mm
	Z-53	Lâmina		Segundo altura	Lat. = L/4-107 mm
				Segundo altura	Cen. = L/4-132 mm
	XP-04	Perfil de batente		4	H-37 mm
	AX-19	Vareta		2	Apro. H/2 mm

### Acessórios e Juntas

Referência	Descrição	Quantidade
30 92 00 41	Terminal de fecho	2
30 94 01 02	Complemento fecho de portada	6
30 92 01 20	Fecho 2ª folha	6
30 94 01 09	Fixador de portada (opcional)	2
30 94 01 10	Fixador de portada 3/4 folhas (opcional)	2
30 94 01 12	Jogo topos para perfil batente	4
30 94 01 24	Dobradiça	4
30 94 01 25	Dobradiça 3ª/4ª folha	4
30 94 01 27	Esquadro de janela	18
30 94 01 38	Cremone abertura exterior	1
30 94 01 39	Kit fixação cremone	1
30 94 01 40	Distanciador 14 mm abertura exterior	2
---	Jogo portalâminas (segundo altura)	4
30 93 01 40	Vedante lâminas	Nº lâminas + 1 L/4
30 94 01 46	Junta interior/exterior	2L+4L/4+14H
30 95 00 30	Pelúcia 7x7 mm	8L/4

### Portalâminas

Hz = H-122 mm
---------------

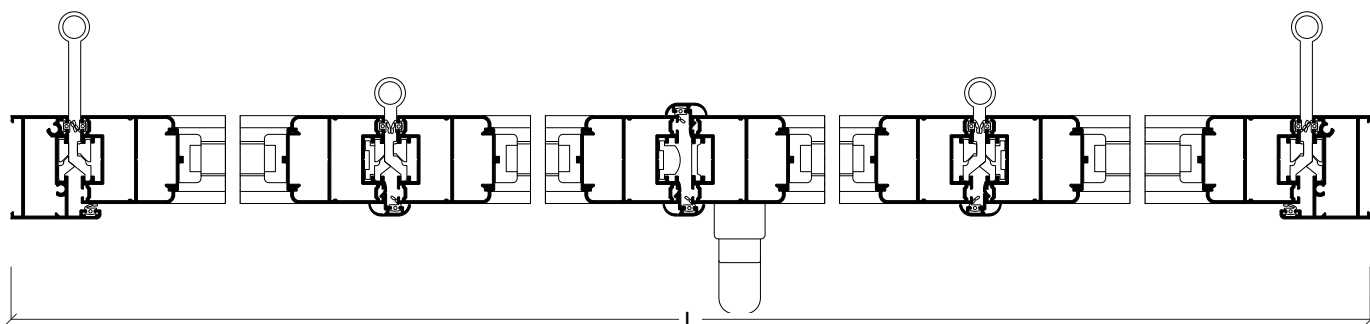



## Porta 2 folhas abertura exterior

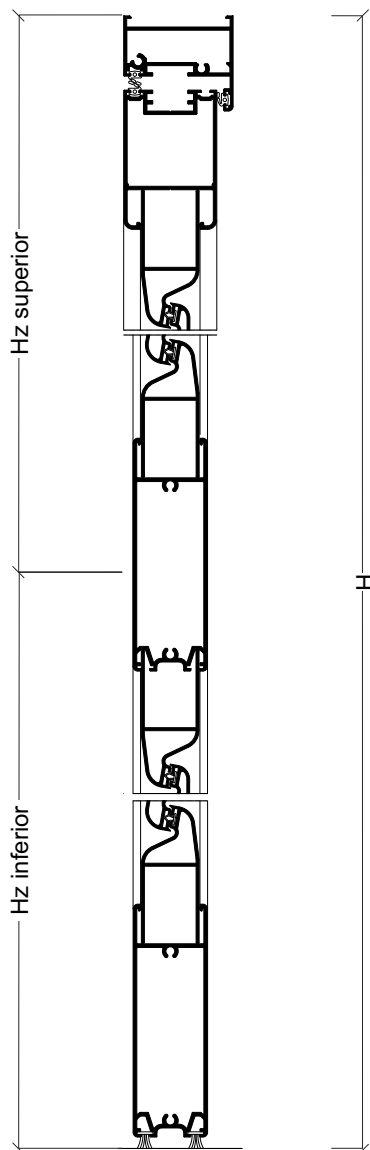
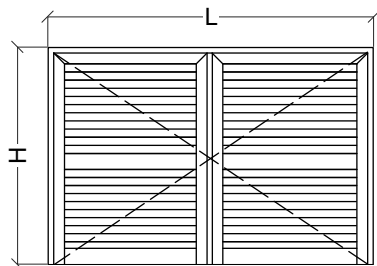

### Perfis

Desenho	Ref	Descrição	Corte	Quant	Medida
	XP-03	Aro fixo		1	L
				2	H
	XP-18	Aro móvel de porta		2	L/2-35 mm
				4	H-37 mm
	XP-16	Almofada 100 mm		4	L/2-154 mm
	XP-01	Meia lâmina		8	L/2-178 mm
	Z-53	Lâmina		Segundo altura	L/2-168 mm
	XP-04	Perfil de batente		2	H-37 mm
	AX-19	Vareta		2	Apro. H/2 mm

### Acessórios e Juntas

Referência	Descrição	Quantidade
30 94 01 38	Cremona abertura exterior	1
30 94 01 02	Complemento fecho de portada	2
30 94 01 39	Kit fixação cremone	1
30 94 01 12	Jogo topos para perfil batente	2
30 94 01 13	Tampa da folha	4
30 94 01 24	Dobradiça	8
30 94 01 27	Esquadro de janela	2
30 94 01 32	Distanciador de travessa	8
30 94 01 33	Esquadro porta	4
30 92 02 40	Fecho 2ª folha	6
30 94 01 40	Distanciador 14 mm abertura exterior	2
30 92 05 60	Puxador duplo	1
---	Jogo portalâminas (segundo Hz superior)	2
---	Jogo portalâminas (segundo Hv inferior)	2
30 93 01 40	Vedante lâminas	Nº lâminas + 2 L/2
30 94 01 46	Junta interior/exterior	2L+2L/2+8H
30 95 00 30	Pelúcia 7x7 mm	4L/2

### Portalâminas



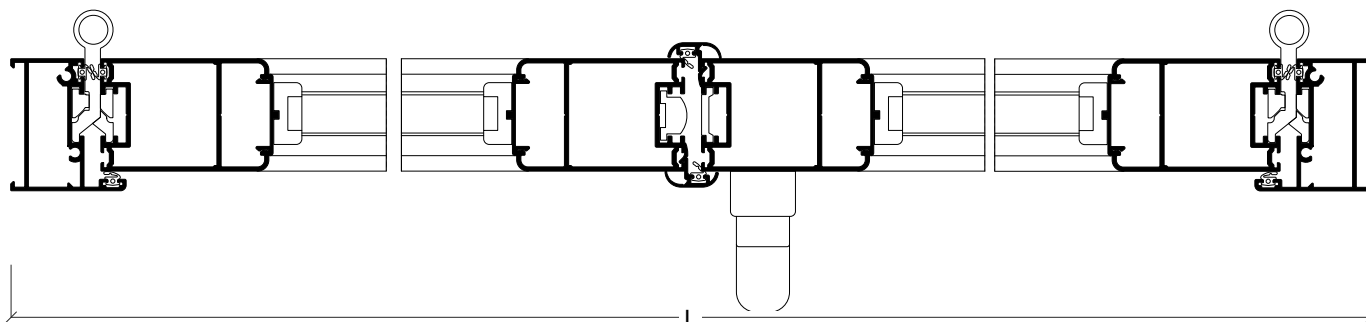



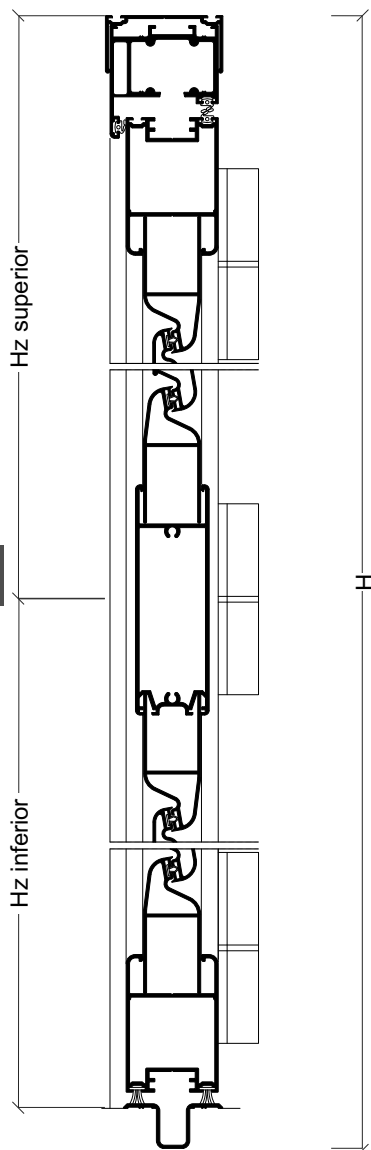
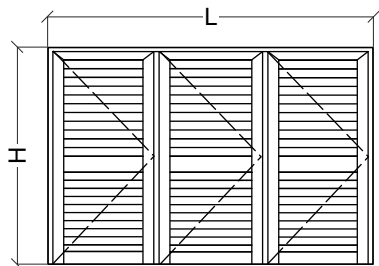











Hz superior = H1-148 mm
Hv inferior = H2-161 mm



## Porta 3 folhas harmónio abertura exterior



### Perfis

Desenho	Ref	Descrição	Corte	Quant	Medida
	XP-20	Distanciador de aro		1	L
	XP-21	Aro fixo para carril		1	L
	XP-03	Aro fixo		2	H-31 mm
	XP-18	Aro móvel de porta		6	L/3-25 mm
				6	H-47 mm
	XP-16	Almofada 100 mm		3	L/3-145 mm
	XP-01	Meia lâmina		12	L/3-168 mm
	Z-53	Lâmina		Segundo altura	L/3-158 mm
	XP-23	Guia de embutir		1	L
	AX-19	Vareta		2	Apro. H

Dimensões máximas: 800x2500 mm por folha  
 Peso máximo: 40 Kg por folha

### Acessórios e Juntas

Referência	Descrição	Quantidade
30 94 01 04	Jogo parafusos distanciadores	2
30 94 01 07	Fecho de embutir portada	2
30 94 01 08	Aplique fixador	2
30 94 01 06	Rolamentos/dobradiças harmónio	1
30 94 01 23	Cremona 4 folhas (opcional a A)	2
30 94 01 24	Dobradiça	8
30 94 01 26	Distanciador de aro	4
30 94 01 32	Distanciador de travessa	8
30 94 01 33	Esquadro porta	12
30 92 00 41	Terminal fecho	2
30 92 00 42	Terminal fecho inferior	2
---	Jogo portalâminas (segundo Hz superior)	3
---	Jogo portalâminas (segundo Hz inferior)	3
30 93 01 40	Vedante lâminas	Nº lâminas + 2 L/3
30 94 01 46	Junta interior/exterior	2L+3L/3+14H
30 95 00 30	Pelúcia 7x7 mm	6L/3

### Portalâminas

Hz superior = H1-156 mm
Hz inferior = H2-123 mm

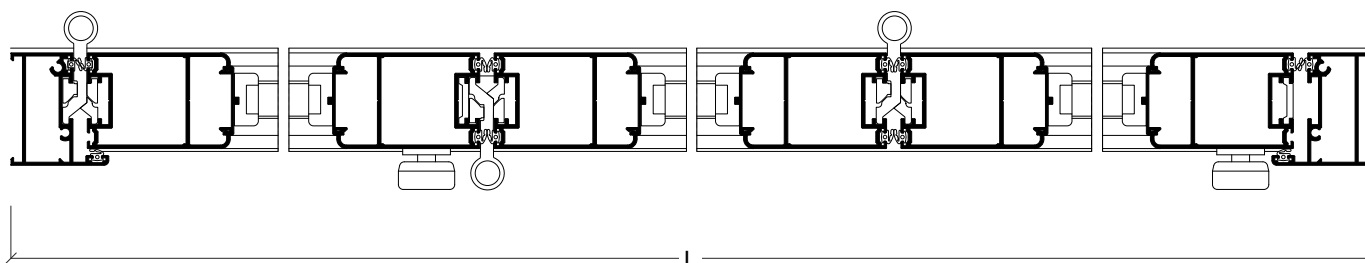

## Porta 5 folhas harmónio abertura exterior com vidro

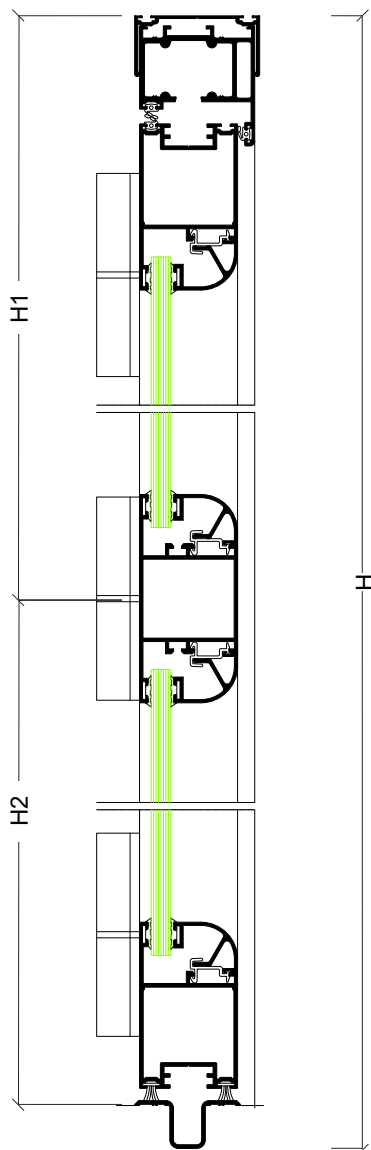
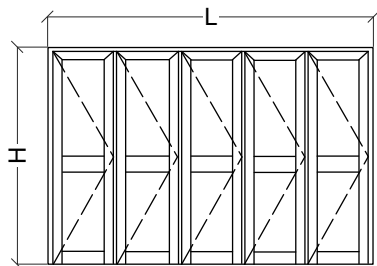

### Perfis

Desenho	Ref	Descrição	Corte	Quant	Medida
	XP-20	Distanciador de aro		1	L
	XP-21	Aro fixo para carril		1	L
	XP-03	Aro fixo		2	H-31 mm
	XP-22	Aro móvel de porta		10	L/5-17 mm
				10	H-47 mm
	AZ-09	Travessa		5	L/5-103 mm
	AZ-06	Bite redondo		10	H1-100 mm
				10	H2-67 mm
	AX-29	Bite redondo		20	L/5-113 mm
	AX-33	Mola bite		A cada 300 mm	80 mm
	XP-23	Guia de embutir		1	L
	AX-19	Vareta		2	Apro. H

Dimensões máximas: 800x2500 mm por folha  
Peso máximo: 40 Kg por folha

### Acessórios e Juntas

Referência	Descrição	Quantidade
30 94 01 04	Jogo parafusos distanciadores	3
30 94 01 07	Fecho de embutir portada	3
30 94 01 08	Aplique fixador	3
30 94 01 06	Rolamentos/dobradiças harmónio	2
30 94 01 23	Cremona 4 folhas (opcional a A)	3
30 94 01 24	Dobradiça	11
30 94 01 26	Distanciador de aro	1 a cada 50 cm
30 94 01 33	Esquadro porta	20
30 92 00 41	Terminal fecho	3
30 92 00 42	Terminal fecho inferior	3
30 92 01 50	União topos porta	10
30 94 01 46	Junta interior/exterior	2L+5L/5+22H
30 95 00 30	Pelúcia 7x7 mm	10L/5
---	Junta exterior vidro	4L+10H
---	Junta interior vidro	4L+10H

### Vidros

L/5-126 mm	H1-123 mm
L/5-126 mm	H2-90 mm

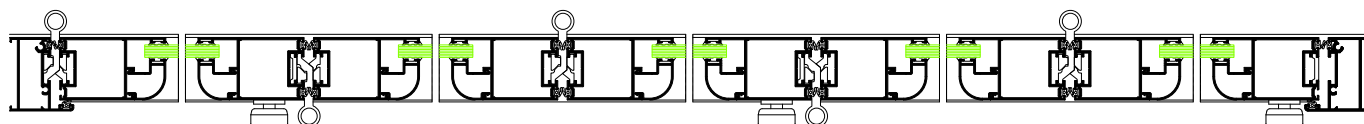

207  
A

## Janela 1 folha correr

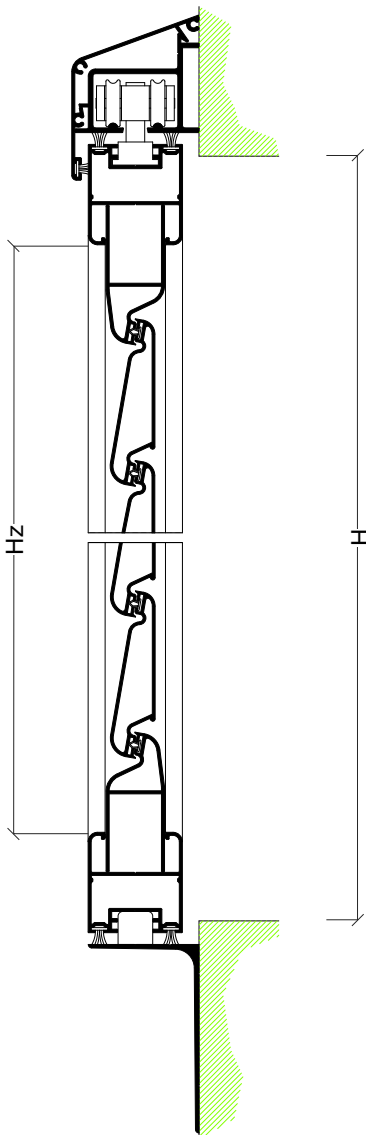
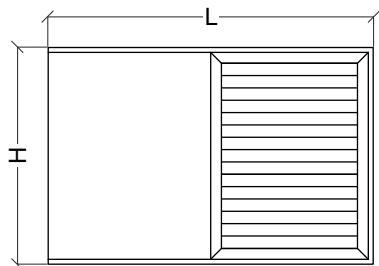

### Perfis

Desenho	Ref	Descrição	Corte	Quant	Medida
	XP-07	Guia superior de correr		1	2L+59 mm
	XP-05	Aro móvel de janela		2	L+10 mm
				2	L+10 mm
	XP-01	Meia lâmina		2	L-99 mm
	Z-53	Lâmina		Segundo altura	L-89 mm
	AX-19	Vareta		2	Apro. H/2 mm
	XP-06	Tampa da guia superior		1	2L+59 mm
	XP-08	Tampa lateral de correr		2	H+10 mm
	XP-15	Guia inferior de correr		1	2L+59 mm

### Acessórios e Juntas

Referência	Descrição	Quantidade
30 94 01 04	Jogo parafusos distanciadores	1
30 94 01 05	Rolamentos portada de correr	2
30 94 01 07	Fecho de embutir portada	1
30 94 01 27	Esquadro de janela	4
30 94 01 34	Fecho superior correr	2
30 94 01 35	Fecho inferior correr	2
30 94 01 36	Tampa lateral	2
30 92 00 41	Terminal fecho	2
---	Jogo portalâminas (segundo altura)	1
30 93 01 40	Vedante lâminas	Nº lâminas + 1 L
30 95 00 10	Pelúcia 7x9 mm	4L+2H+12L

### Portalâminas



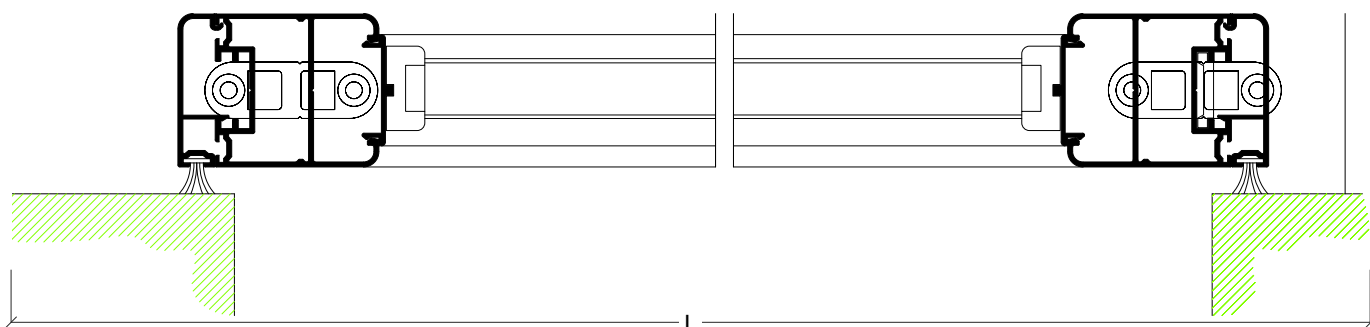



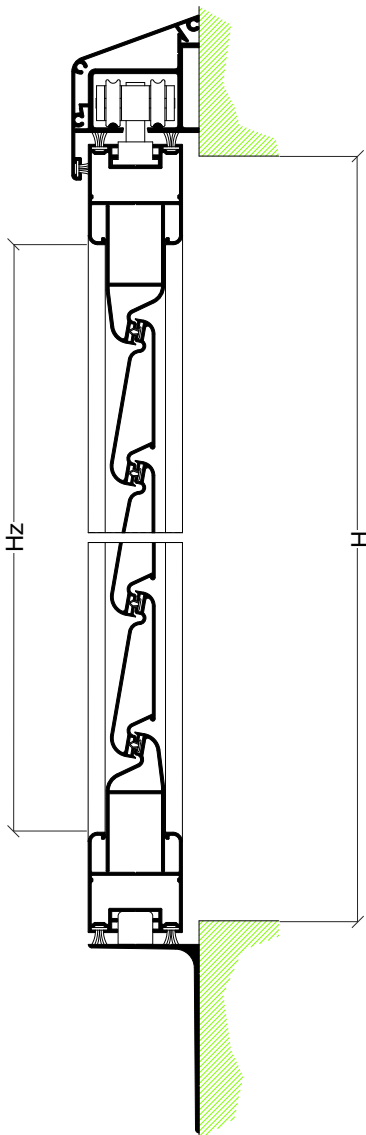
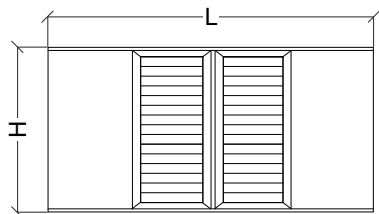

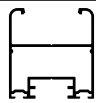

Hz = H-75 mm
--------------

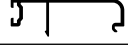

## Janela 2 folhas correr



### Perfis

Desenho	Ref	Descrição	Corte	Quant	Medida
	XP-07	Guia superior de correr		1	2L+19 mm
	XP-05	Aro móvel de janela		4	L/2 mm
				4	H+10 mm
	XP-01	Meia lâmina		4	L/2-109 mm
	Z-53	Lâmina		Segundo altura	L/2-99 mm
	AX-19	Vareta		2	Apro. H/2 mm
	XP-06	Tampa da guia superior		1	2L+19 mm
	XP-08	Tampa lateral de correr		2	H+10 mm
	XP-15	Guia inferior de correr		1	2L+19 mm
	XP-17	Perfil de batente		2	H-7 mm

### Acessórios e Juntas

Referência	Descrição	Quantidade
30 94 01 04	Jogo parafusos distanciadores	2
30 94 01 05	Rolamentos portada de correr	4
30 94 01 07	Fecho de embutir portada	2
30 94 01 12	Jogo topos para perfil batente	2
30 94 01 27	Esquadro de janela	8
30 94 01 34	Fecho superior correr	3
30 94 01 35	Fecho inferior correr	3
30 94 01 36	Tampa lateral	2
30 92 00 41	Terminal fecho	4
---	Jogo portalâminas (segundo altura)	2
30 93 01 40	Vedante lâminas	Nº lâminas + L/2
30 95 00 10	Pelúcia 7x9 mm	8L/2+4H+12L

209

### Portalâminas

Hz = H-75 mm
--------------

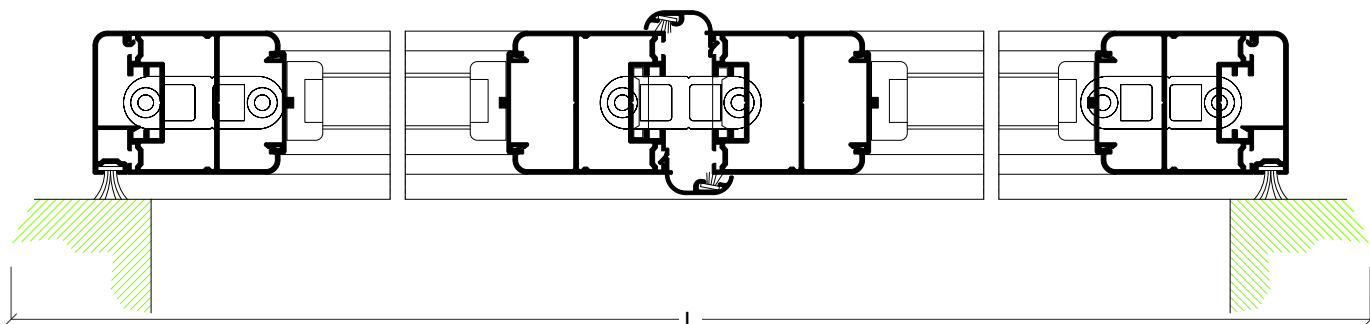

## Janela 2 folhas correr afastada

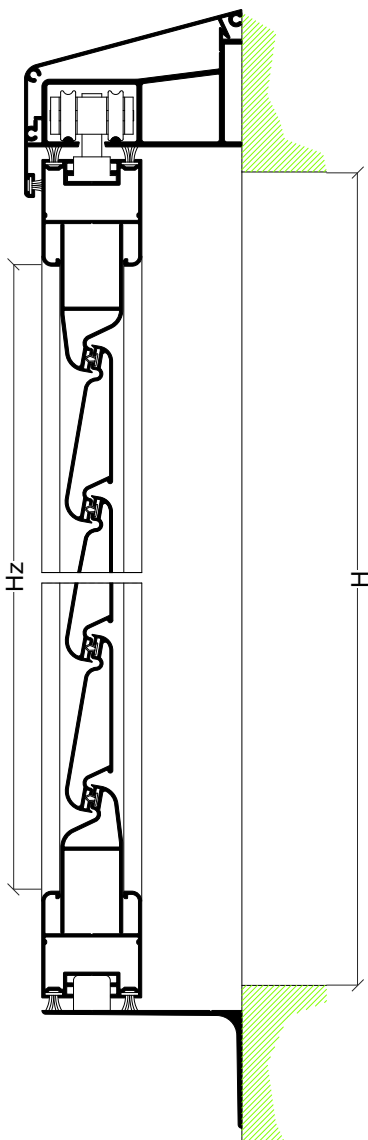
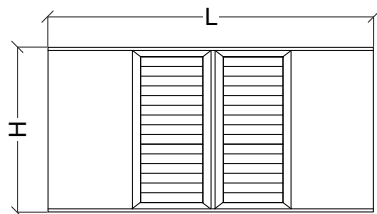

### Perfis

Desenho	Ref	Descrição	Corte	Quant	Medida
	XP-13	Guia superior de correr larga		1	2L+19 mm
	XP-05	Aro móvel de janela		4	L/2 mm
				4	H+10 mm
	XP-01	Meia lâmina		4	L/2-109 mm
	Z-53	Lâmina		Segundo altura	L/2-99 mm
	AX-19	Vareta		2	Apro. H/2 mm
	XP-12	Tampa guia superior larga		2	2L+19 mm
	XP-14	Tampa lateral de correr larga		2	H+10 mm
	XP-15	Guia inferior de correr		1	2L+19 mm
	XP-17	Perfil de batente		2	H-7 mm

### Acessórios e Juntas

Referência	Descrição	Quantidade
30 94 01 04	Jogo parafusos es	2
30 94 01 05	Rolamentos portada de correr	4
30 94 01 07	Fecho de embutir portada	2
30 94 01 12	Jogo topos para perfil batente	2
30 94 01 27	Esquadro de janela	8
30 94 01 34	Fecho superior correr	3
30 94 01 35	Fecho inferior correr	3
30 94 01 36	Tampa lateral	2
30 92 00 41	Terminal fecho	4
---	Jogo portalâminas (segundo altura)	2
30 93 01 40	Vedante lâminas	Nº lâminas + L/2
30 95 00 10	Pelúcia 7x9 mm	8L/2+4H+12L

### Portalâminas

Hz = H-75 mm
--------------

