

Sistema

AKi

Sistema AKi

Sistema de batente com RPT - 75 mm

Características do sistema

Sistema de batente com rotura térmica de elevadas prestações térmicas e acústicas.

O sistema AKi possibilita a execução de 5 versões de caixilharia:

1. Linha recta;
2. Linha curva;
3. Linha tradição;
4. Linha oval;
5. Folha Oculta 3D.

O sistema AKi permite a aplicação de vidros duplos ou triplos de alto rendimento de modo a responder às exigências de isolamento térmico e acústico.

A versão AKi Folha Oculta permite a ocultação do aro móvel.

Perfis de alumínio

Os perfis de alumínio são extrudidos na liga de alumínio 6060 para arquitectura de acordo com norma NP EN 12020-02;

Rotura térmica obtida por inserção de varetas isolantes de poliamida tipo ómega de 39 mm, reforçadas com 25% de fibra de vidro;

Espessura média dos perfis de alumínio de 1.5 mm para janelas e de 1.7 mm para portas.

Aros fixos

Secção dos aros fixos de 75 mm ou 99.5 mm com tripla câmara;

Aros fixos com esquadros duplos para montagem a meia esquadria;

Aros fixos tradicionais para mercado interno;

Aros fixos com clip exterior e aba de remate direta de 25 mm ou 45 mm;

Aros fixos com clip exterior e interior para aplicação de remate de 30 mm.

Aros móveis

Secção dos aros móveis de 83 mm com tripla câmara;

Enchimento para vidro duplo ou triplo de 24 mm a 60 mm no sistema AKi;

Enchimento para vidro duplo ou triplo até 34 mm no sistema AKi Folha Oculta 3D;

Aros móveis de linha recta, curva ou tradição;

Aros móveis com esquadros duplos para montagem a meia esquadria;

Perfil inversor de linha recta.

Dimensionamento e manobralidade

Dimensões mínimas - máximas de folha: 457 mm - 1700 mm (L); 600 mm - 2700 mm (H);

Possibilidades de abertura: fixo, batente interior 1 ou 2 folhas com oscilo-batente, exterior, basculante, projectante, pivotante, harmónio e oscilo-paralela;

Estanquidade assegurada através de juntas triplas em EPDM.

Performances

Sistema certificado por laboratório notificado para Ensaio Tipo Inicial (ITT) de acordo com a norma de produto EN 14351-1 para efeitos de Marcação CE.

Categorias alcançadas na avaliação do sistema AKi tipologia janela:

1. Permeabilidade ao ar: Classe 4 (norma de ensaio EN 1026)
2. Estanquidade à água: Classe E750 (norma de ensaio EN 1027)
3. Resistência ao vento: Classe C5 (norma de ensaio EN 12211)

Categorias alcançadas na avaliação do sistema AKi tipologia porta:

1. Permeabilidade ao ar: Classe 4 (norma de ensaio EN 1026)
2. Estanquidade à água: Classe E1200 (norma de ensaio EN 1027)
3. Resistência ao vento: Classe C2 (norma de ensaio EN 12211)
4. Resistência à torção estática: Apto 350N (norma de ensaio EN 14609)

Categorias alcançadas na avaliação do sistema AKi – Folha Oculta 3D tipologia janela:

1. Permeabilidade ao ar: Classe 4 (norma de ensaio EN 1026)
2. Estanquidade à água: Classe E750 (norma de ensaio EN 1027)
3. Resistência ao vento: Classe C5 (norma de ensaio EN 12211)

Coefficiente de transmissão térmica de vão de 2 folhas, sistema AKi, com 1.20 m x 1.50 m com vidro $U_g = 0.5 \text{ W/m}^2\text{K}$, com intercalar efeito "Warm Edge":

• $U_w = 1.00 \text{ W/m}^2\text{K}$

Coefficiente de transmissão térmica de vão de 2 folhas, sistema AKi- Folha Oculta 3D, com 1.80m x 2.20m com vidro $U_g = 0.7 \text{ W/m}^2\text{K}$, com intercalar efeito "Warm Edge":

• $U_w = 1.11 \text{ W/m}^2\text{K}$

Coefficiente de atenuação acústica de vão de 2 folhas com vidro 4/14 (gás Argon)/6:

• $R_w \text{ (C; Ctr)} = 34 \text{ dB (-1; -4)}$

Zonas de aplicação segundo RCCTE (em função do valor U_g): I1, I2, I3, V1, V2, V3.

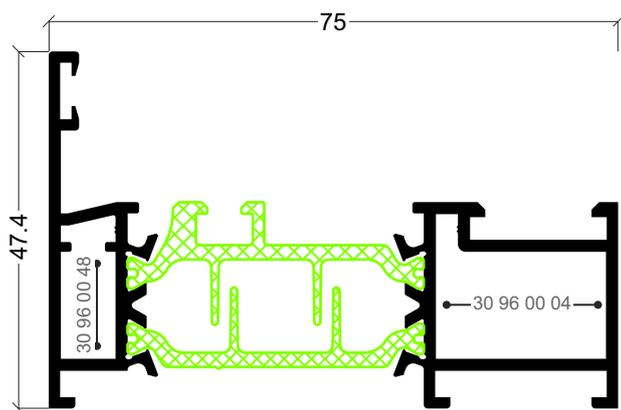

AKi-03
Aro fixo

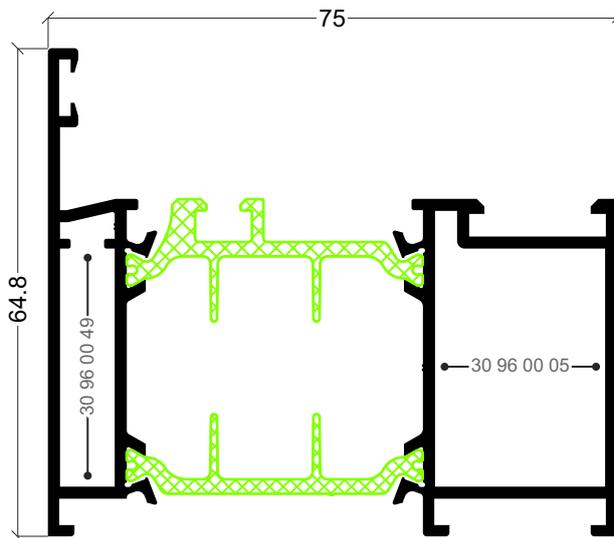

AKi-08
Aro fixo

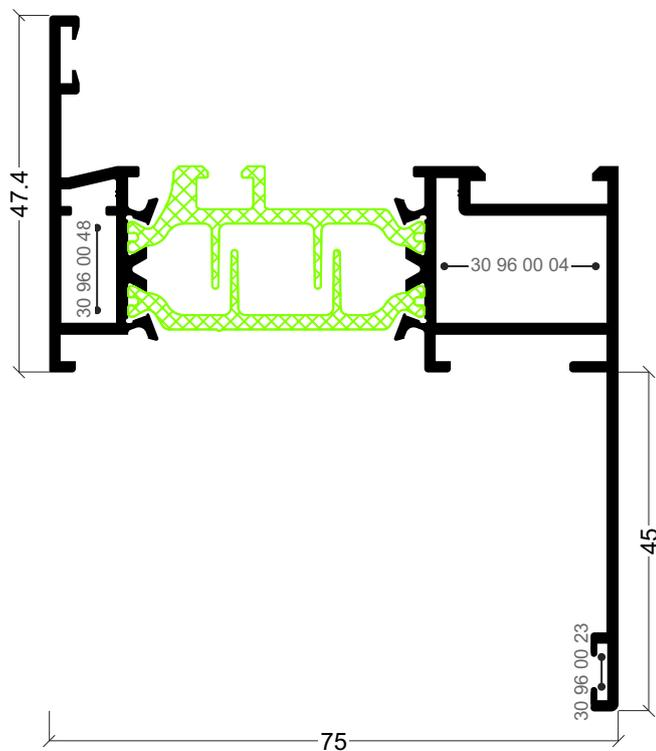

AKi-33
Aro fixo com remate 45 mm

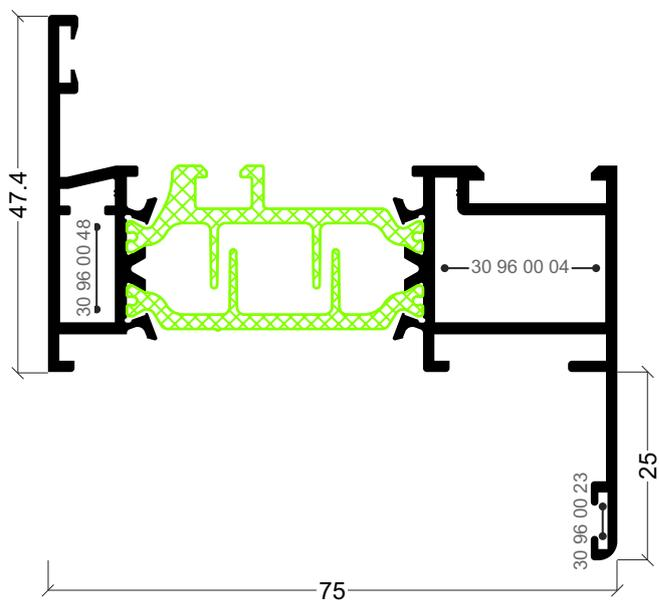

AKi-35
Aro fixo com remate 25 mm

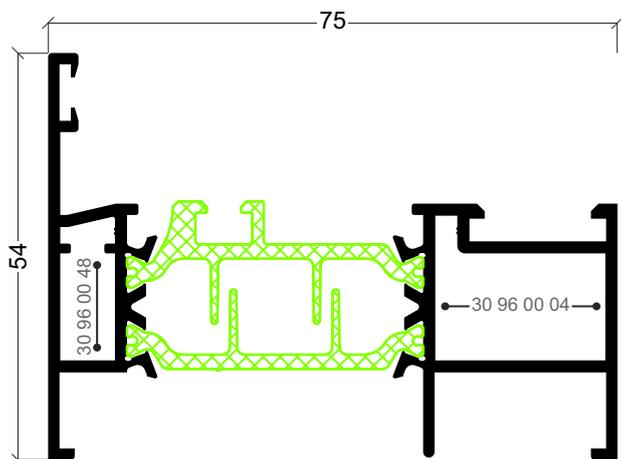

AKi-81
Aro fixo

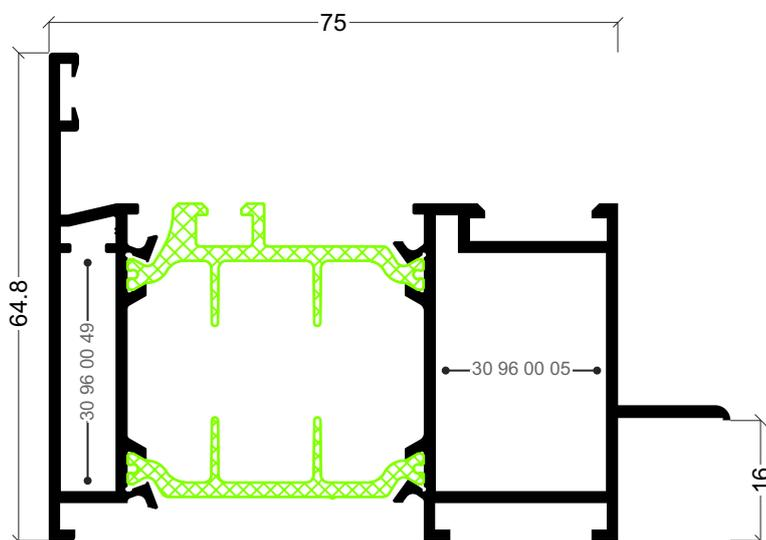

AKi-68
Aro fixo para apanelado

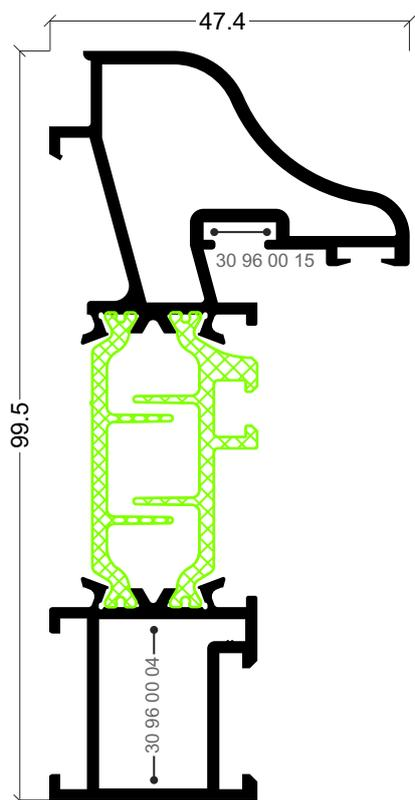

AKi-57
Aro fixo

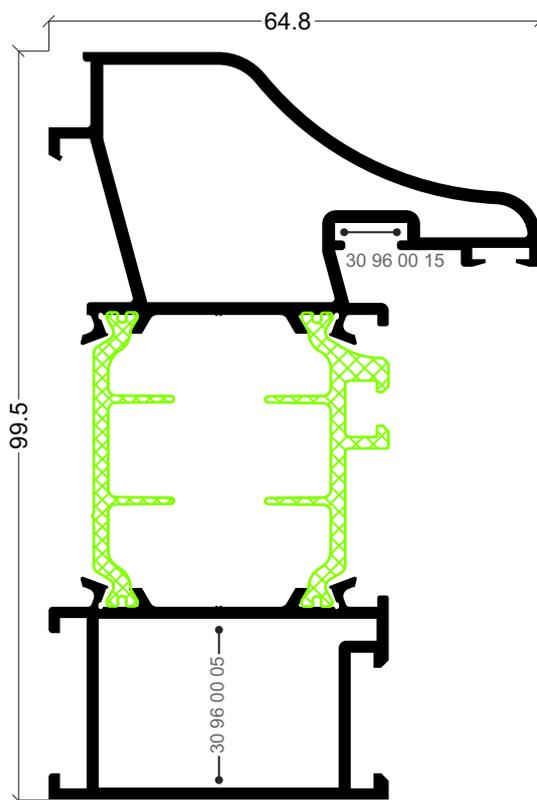

AKi-59
Aro fixo

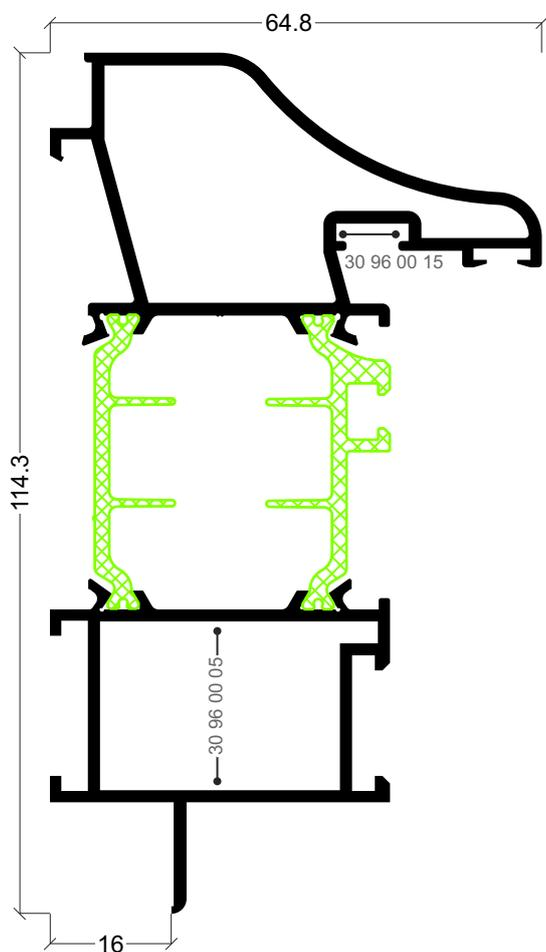

AKi-69
Aro fixo para apanelado

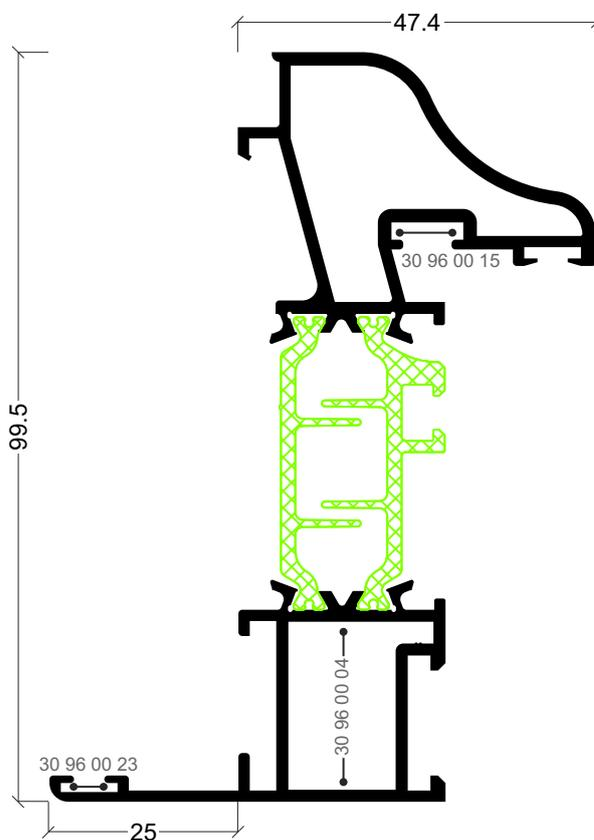

AKi-77
Aro fixo com remate

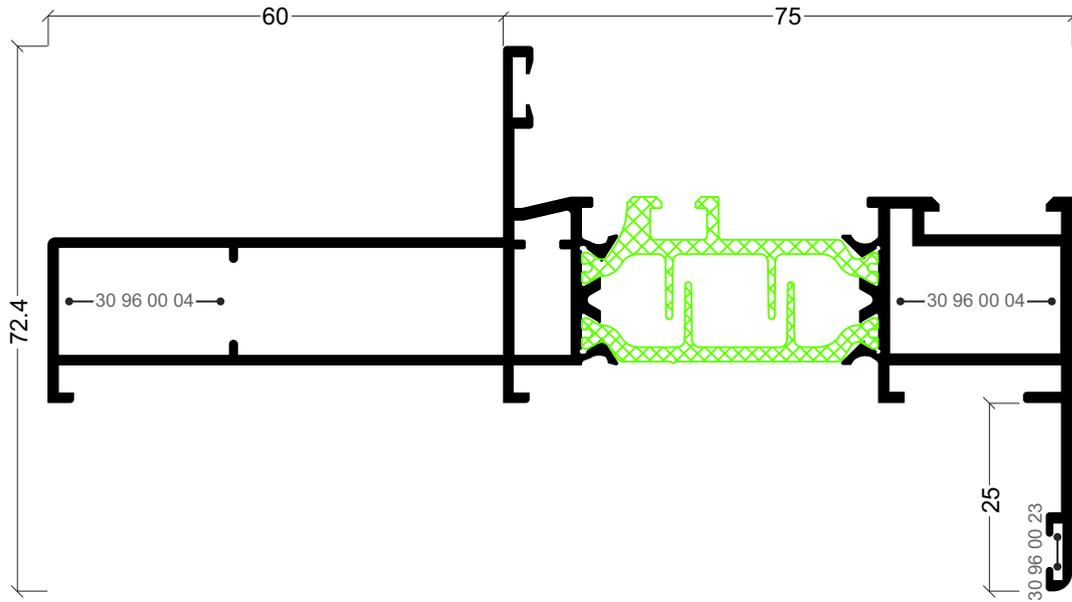

AKi-86
Aro fixo com remate

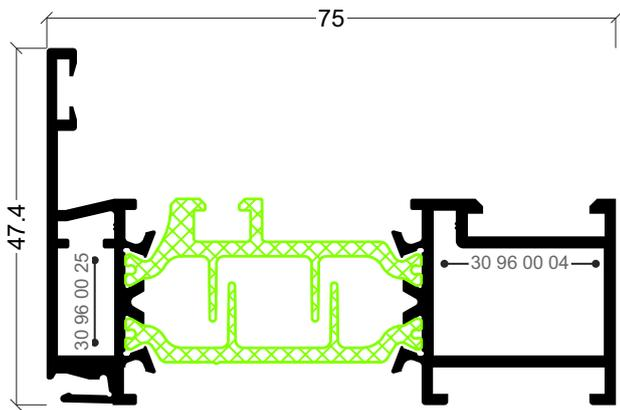

AKi-76
Aro fixo

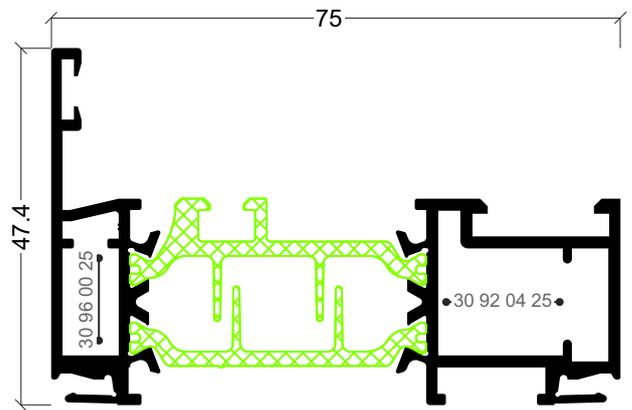

AKi-80
Aro fixo com clip interior/exterior

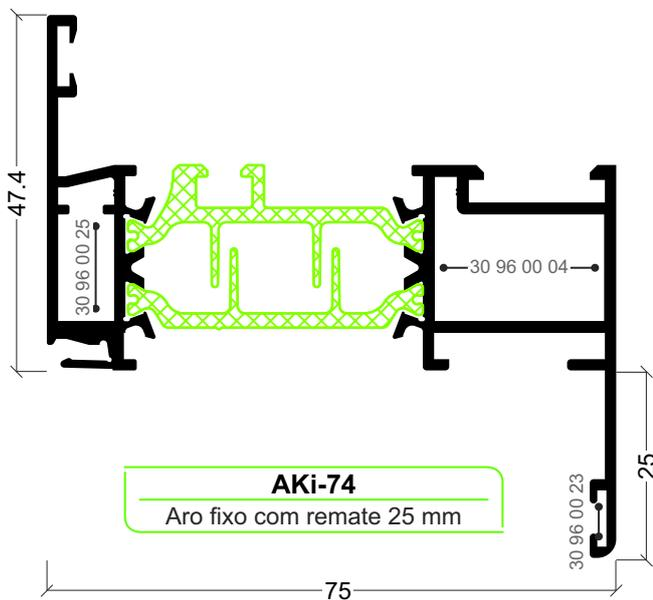

AKi-74
Aro fixo com remate 25 mm

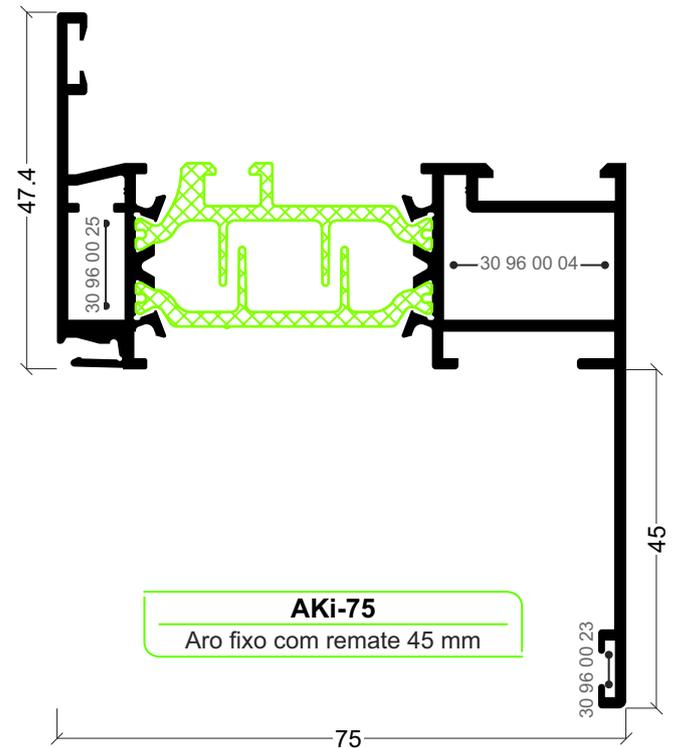

AKi-75
Aro fixo com remate 45 mm

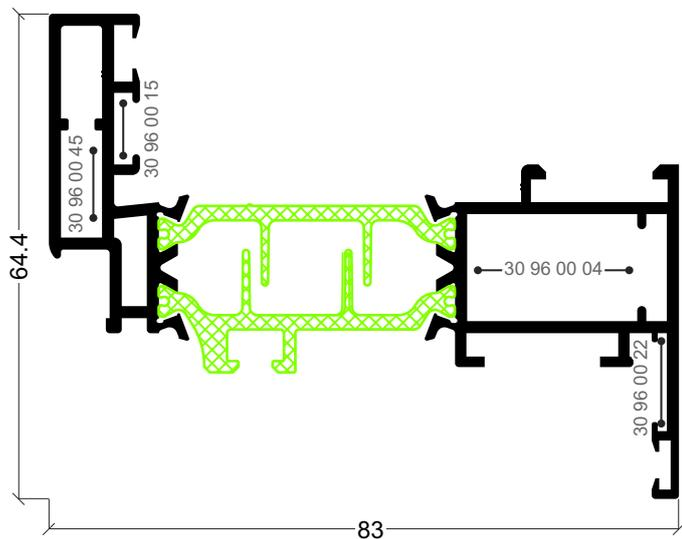

AKi-61
Aro móvil

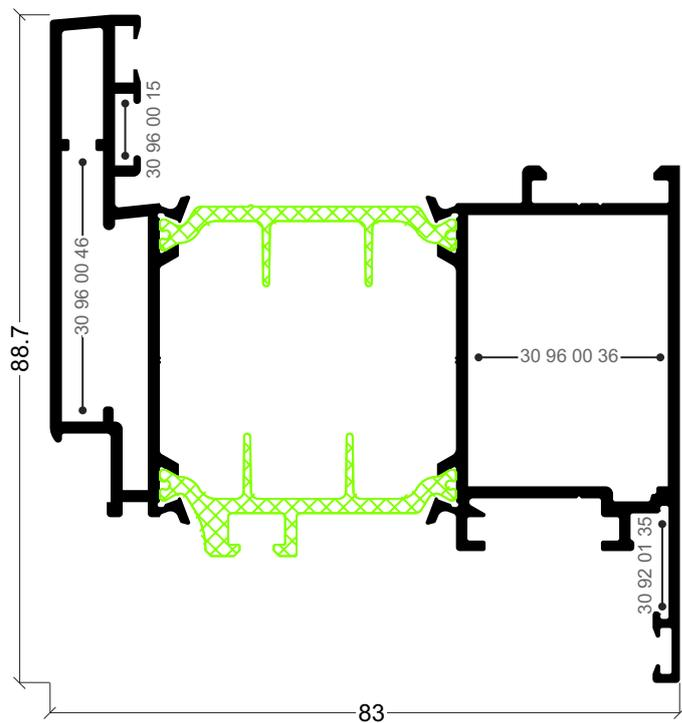

AKi-36
Aro móvil

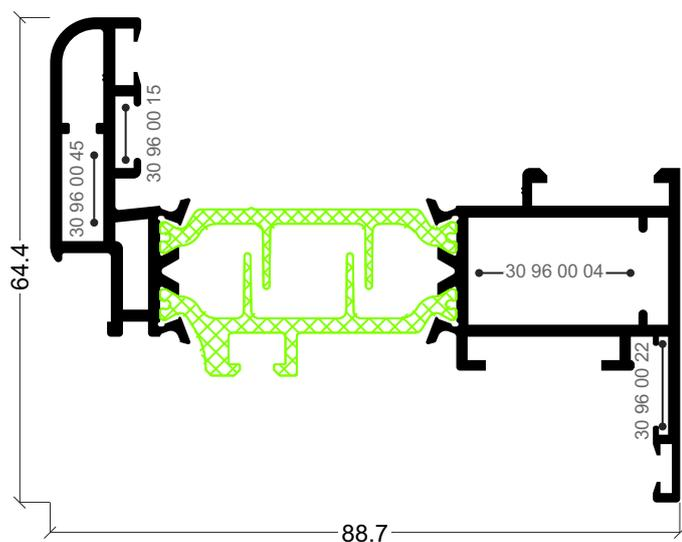

AKi-05
Aro móvil

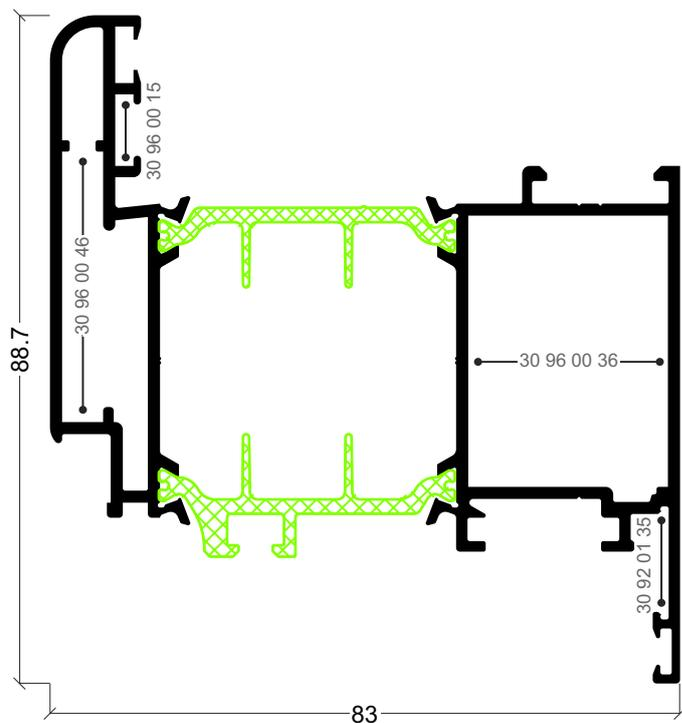

AKi-10
Aro móvil

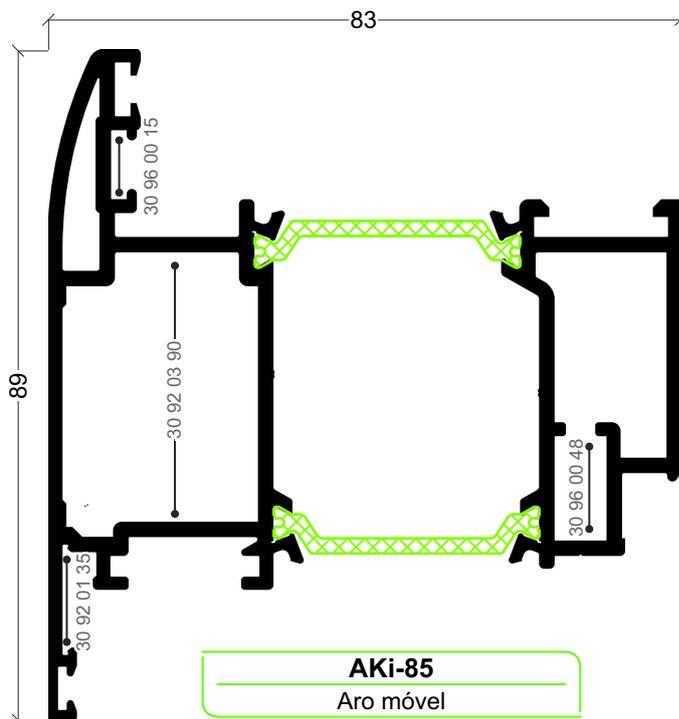
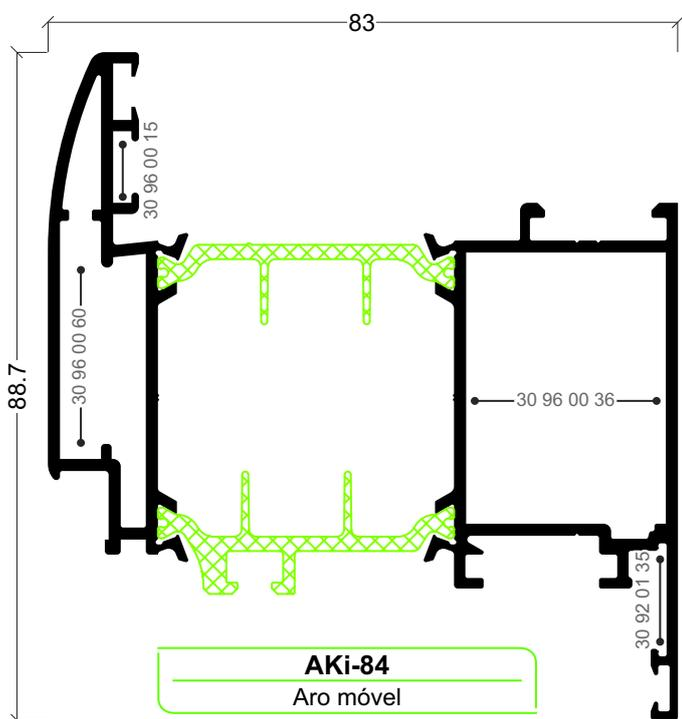
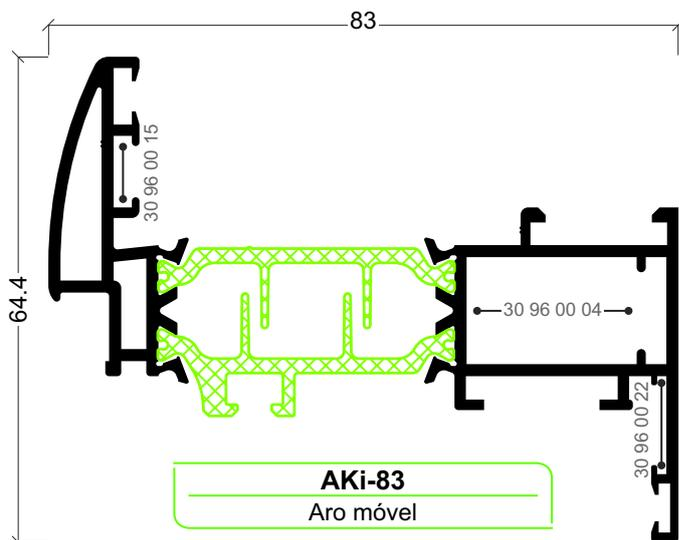
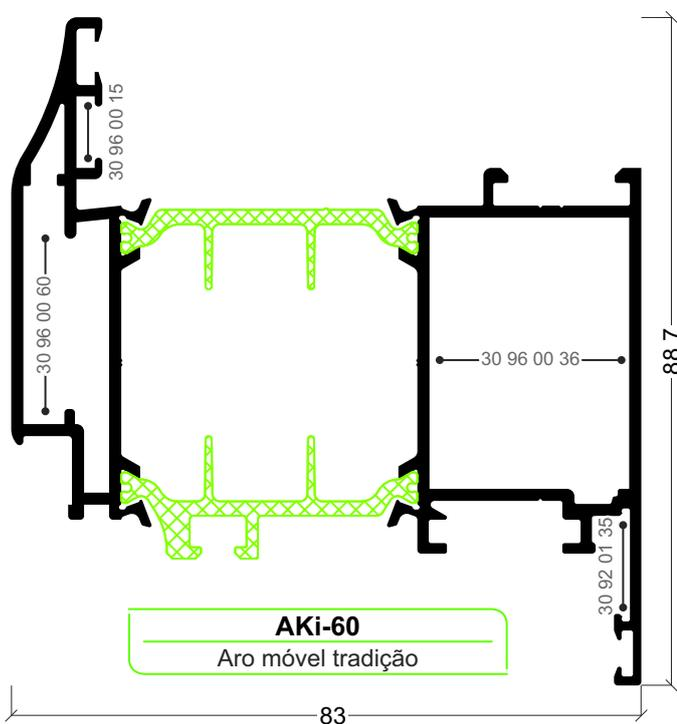
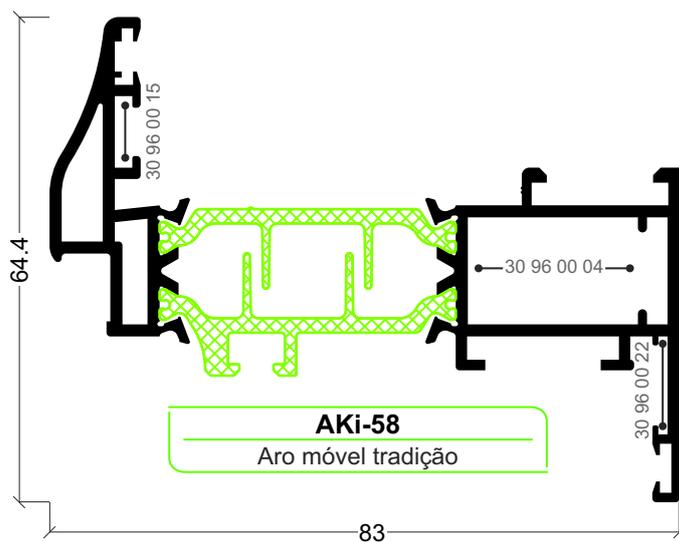

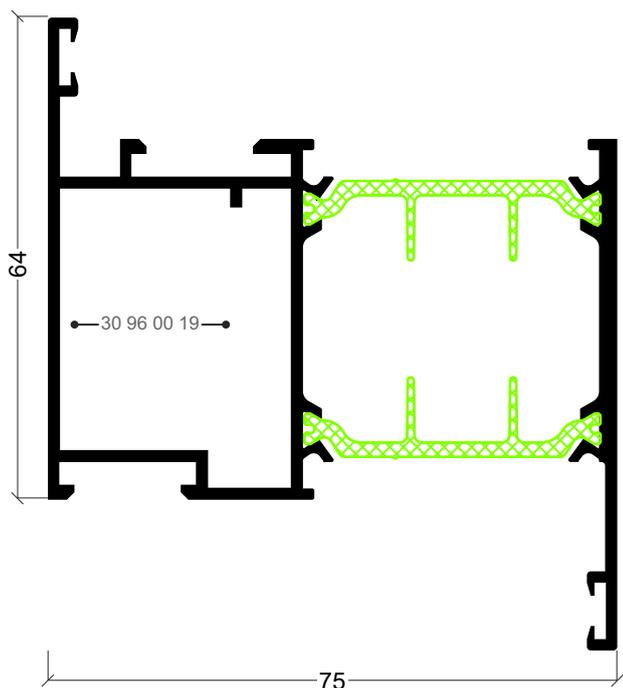

AKi-11
Aro fixo ab.exterior c/ fixo lateral

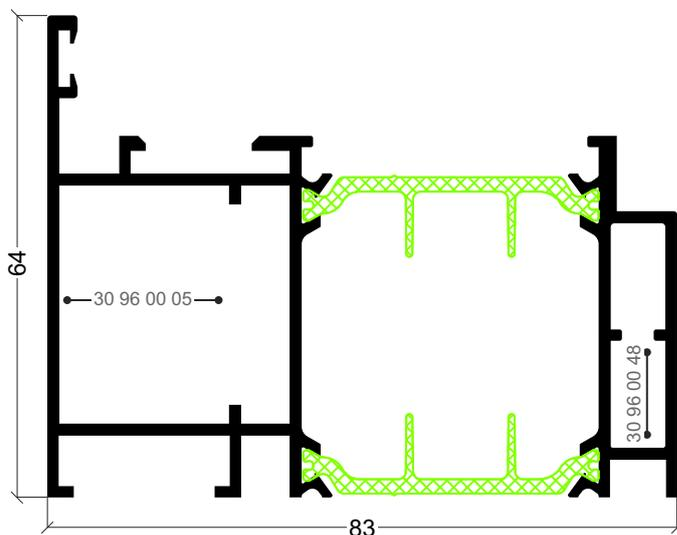

AKi-09
Aro fixo abertura exterior AKi-25

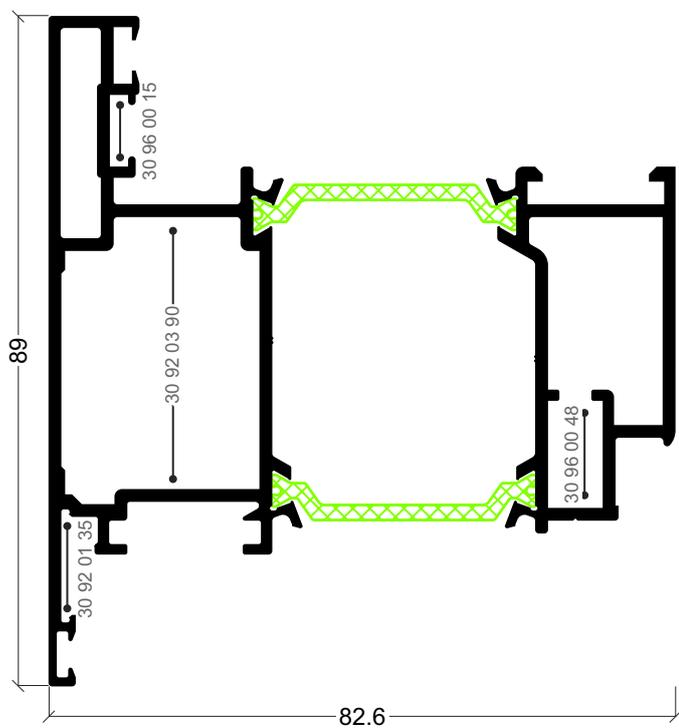

AKi-72
Aro móvel abertura exterior

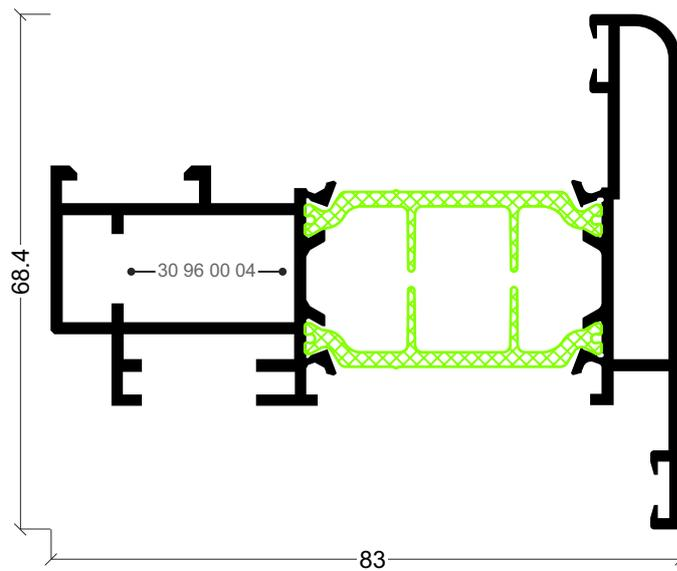

AKi-02
Aro móvel pivotante

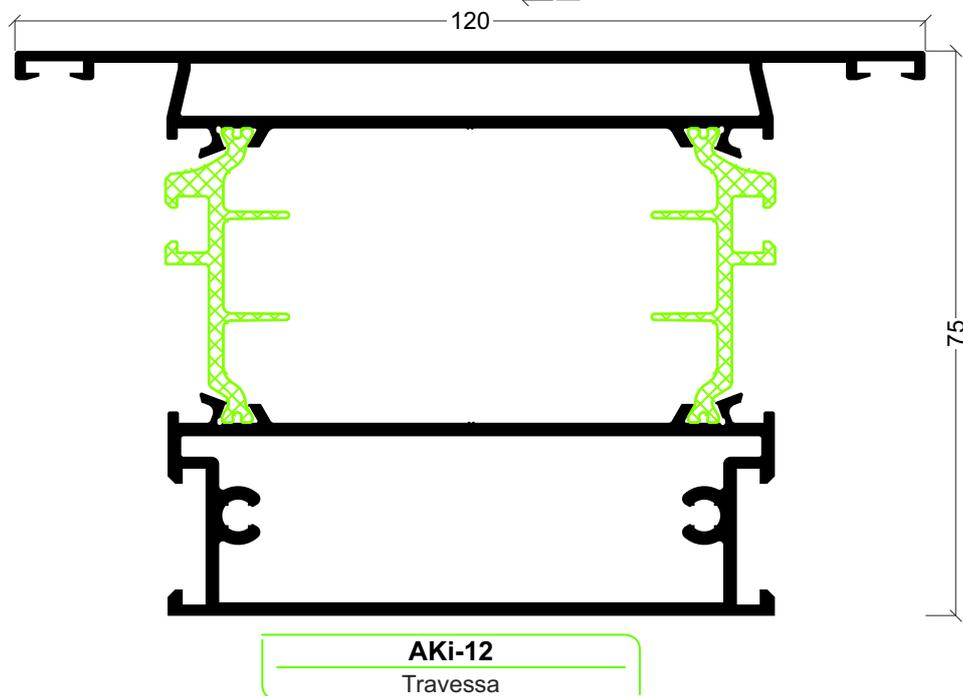
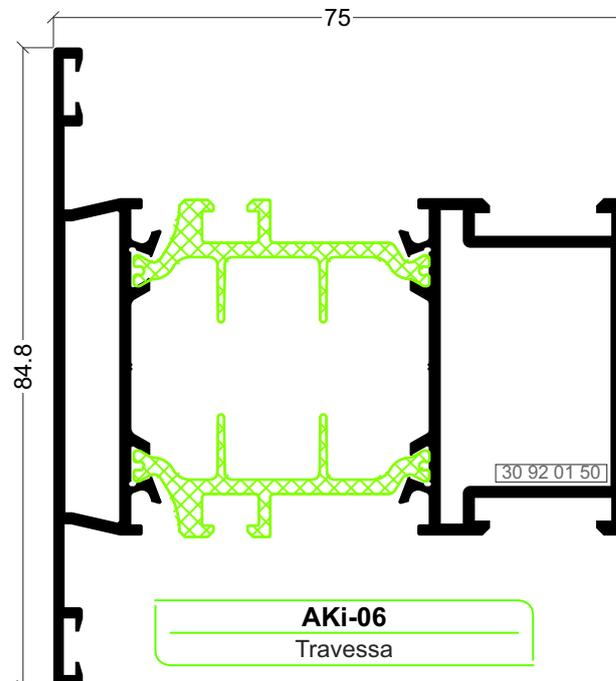
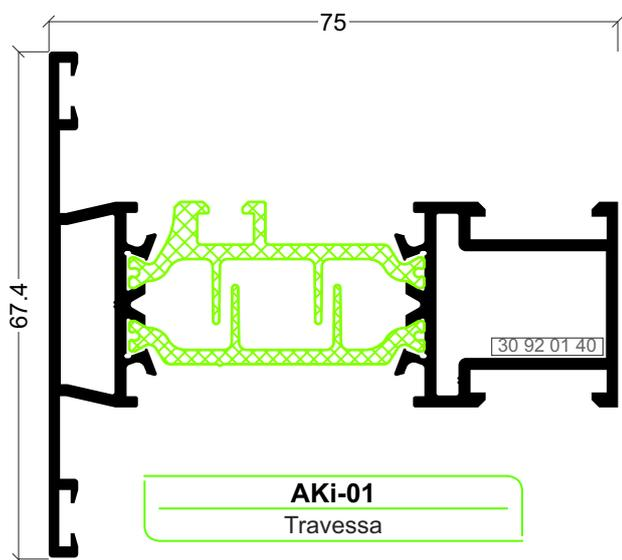
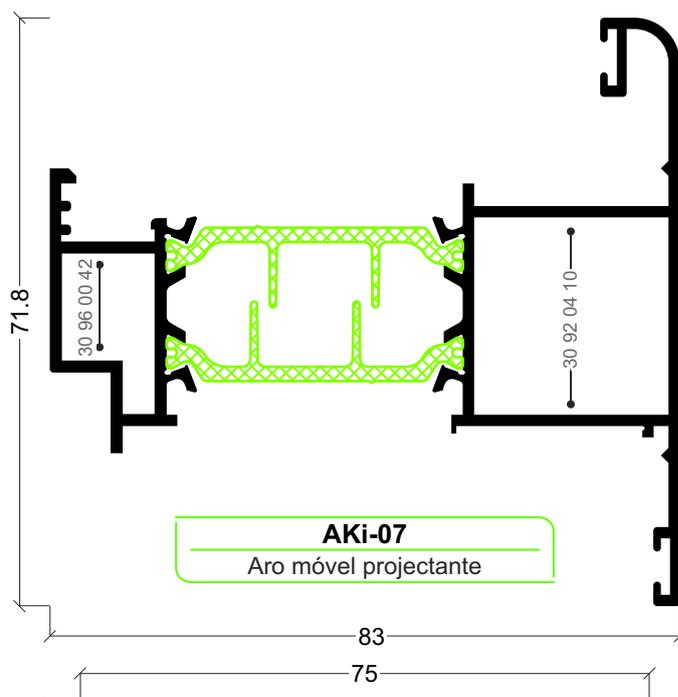
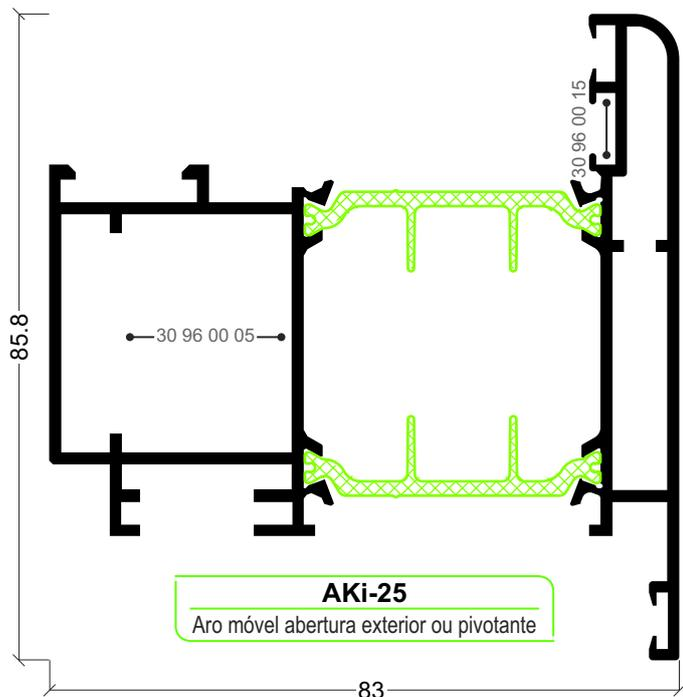

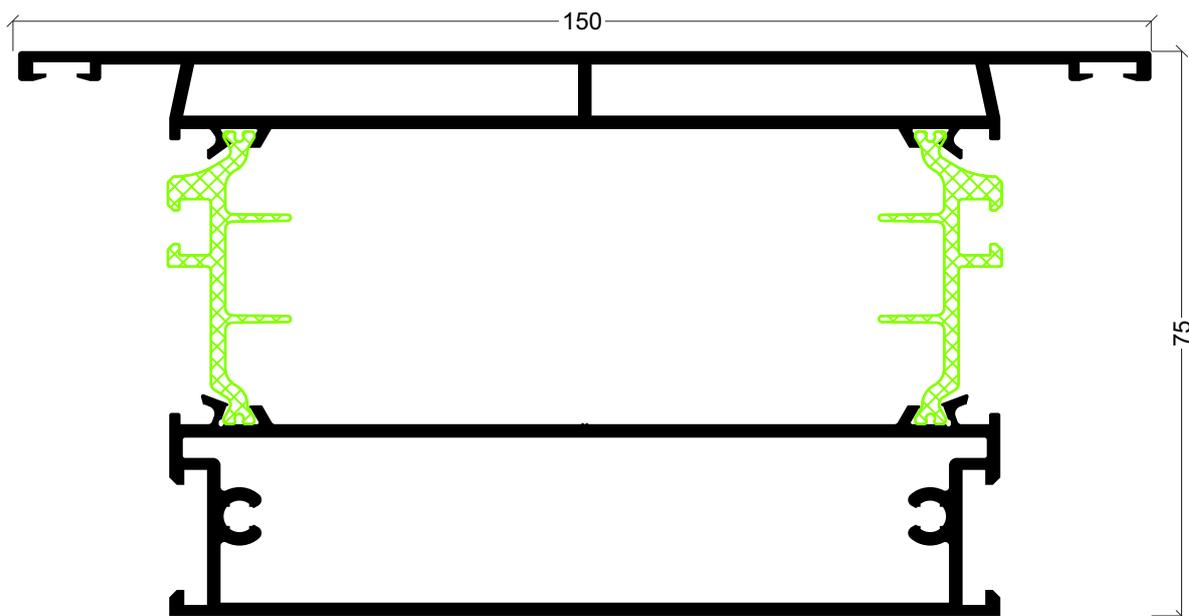

AKi-13
Travessa

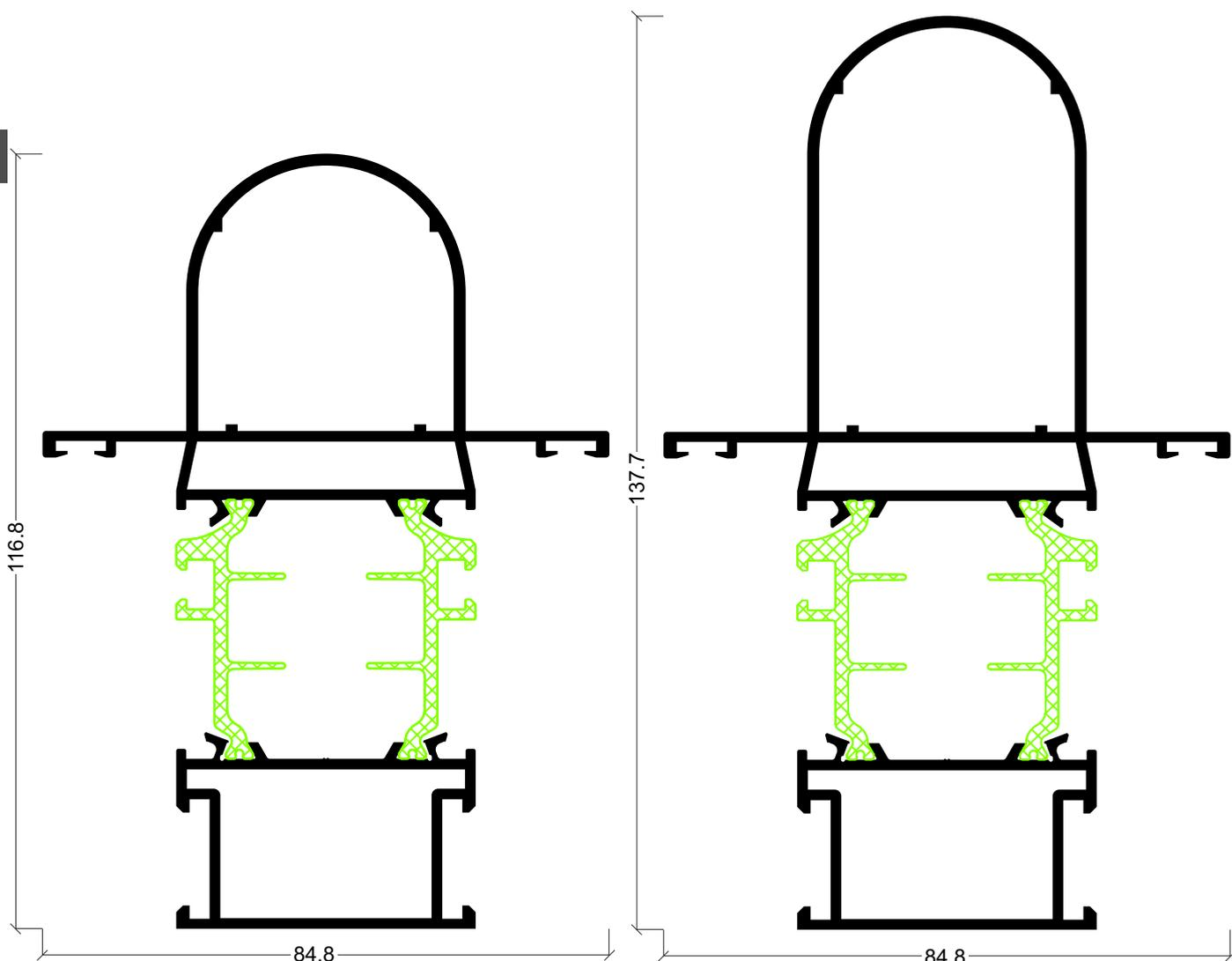

AKi-17
Montante

AKi-18
Montante

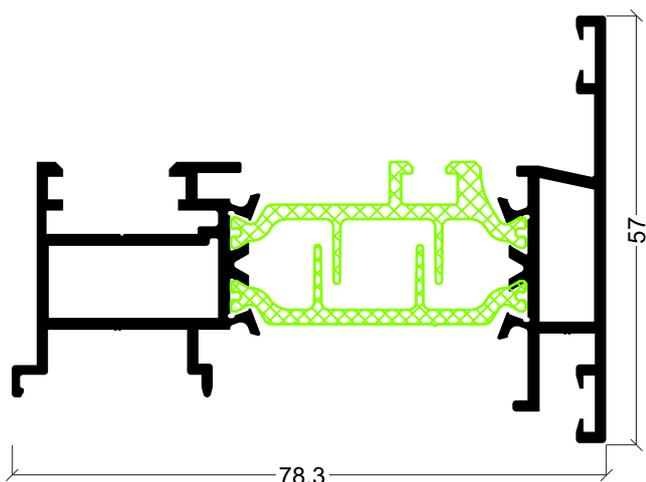

AKi-04
Inversor

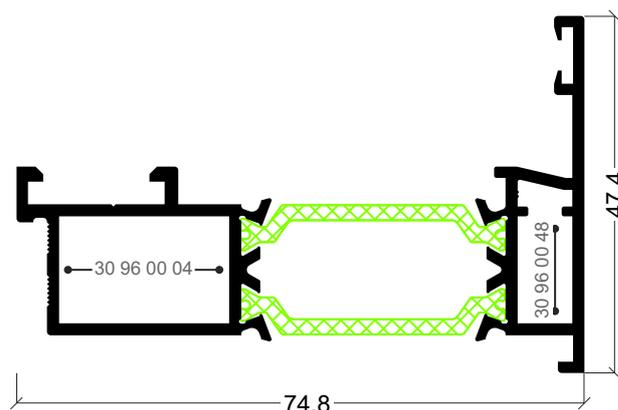

AKi-73
Inversor de sentido de abertura

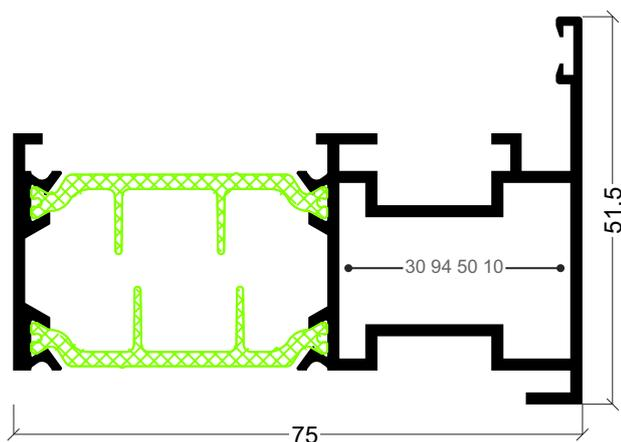

AKi-14
Inversor pivotante

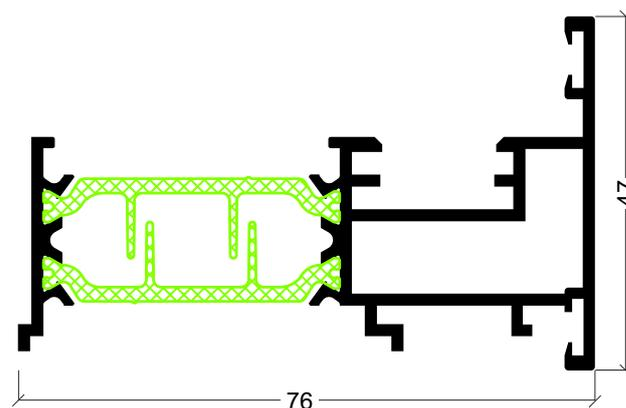

AKi-15
Inversor para ARI-25

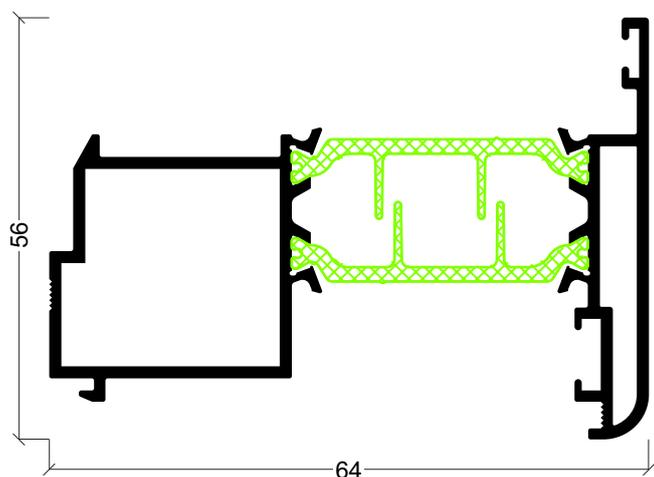

AKi-51
Inversor projectante

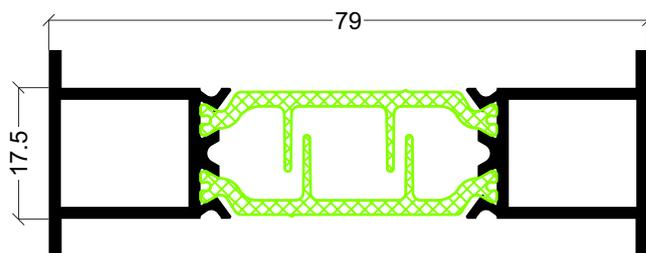

AKi-21
União de aros

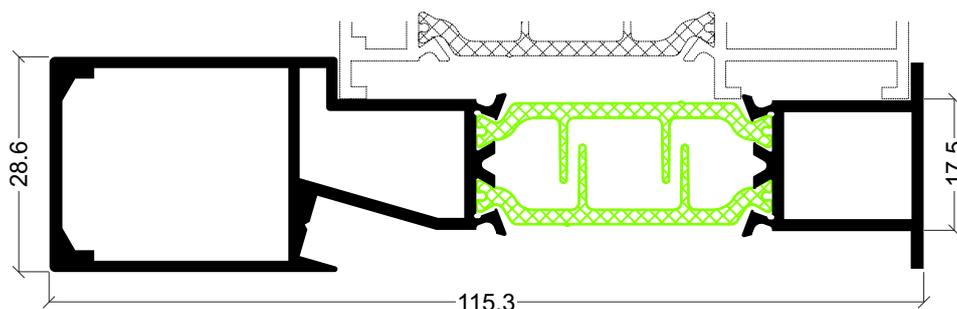

AKi-65
União de aros com reforço

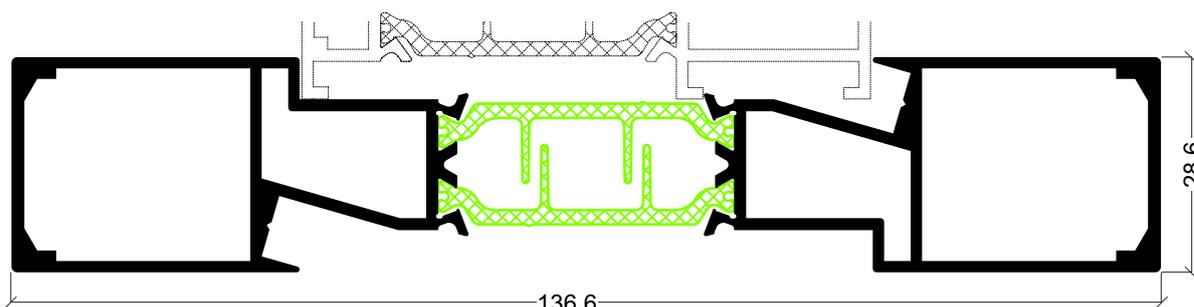

AKi-67
União de aros com reforço

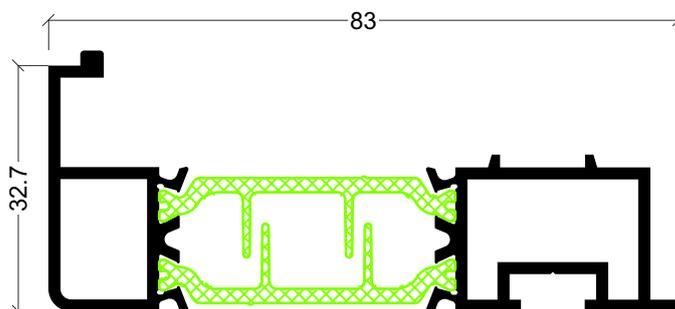

AKi-23
Remate almofada

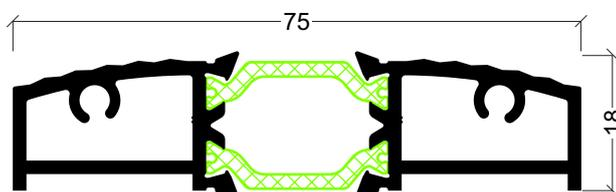

ATI-69
Remate inferior porta

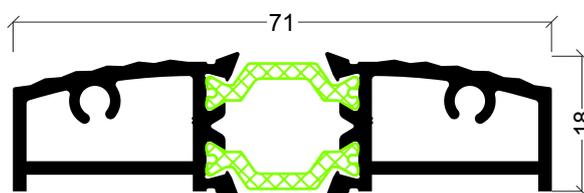

AKi-82
Remate inferior porta

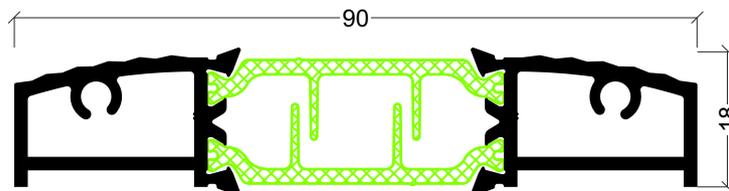

AKi-70
Remate inferior porta

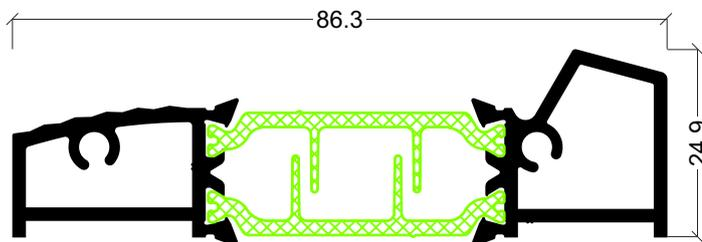

AKi-63
Remate inferior porta

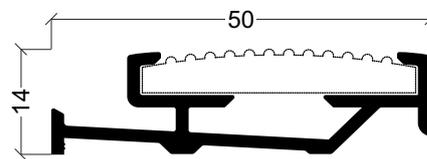

AZ-69
Remate inferior porta

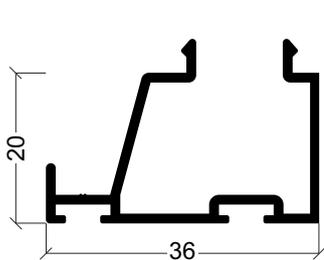

AX-15
Bite remate

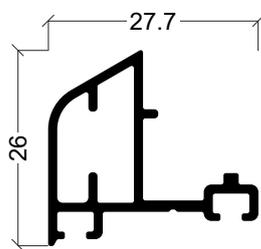

AZ-79
Pingadeira

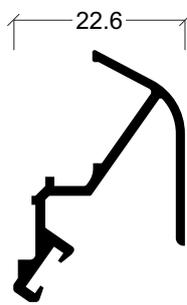

ARi-62
Pingadeira inferior porta

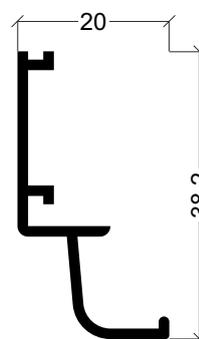

ARi-32
Complemento condensação

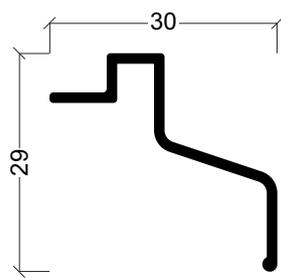

AXi-45
Pingadeira

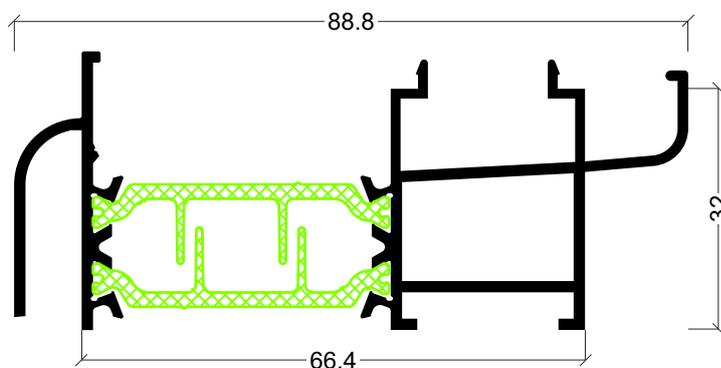

AKi-49
Soleira condensação

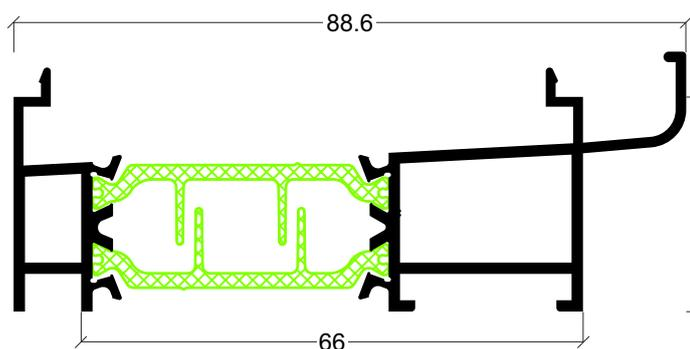

AKi-71
Soleira condensação

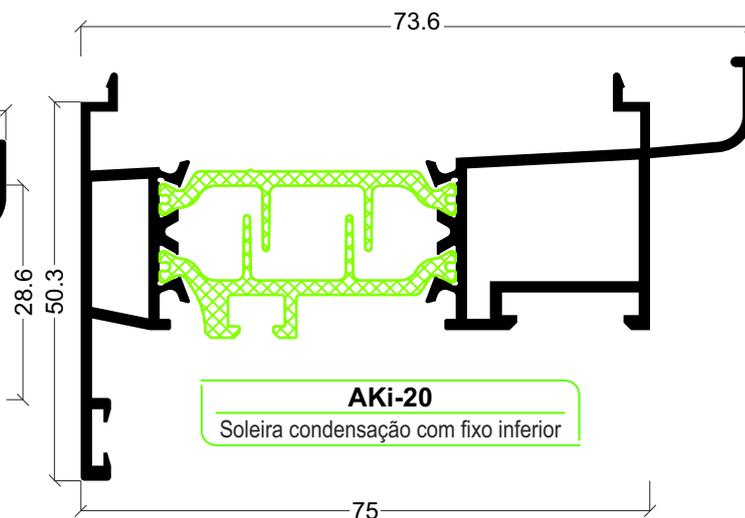

AKi-20
Soleira condensação com fixo inferior

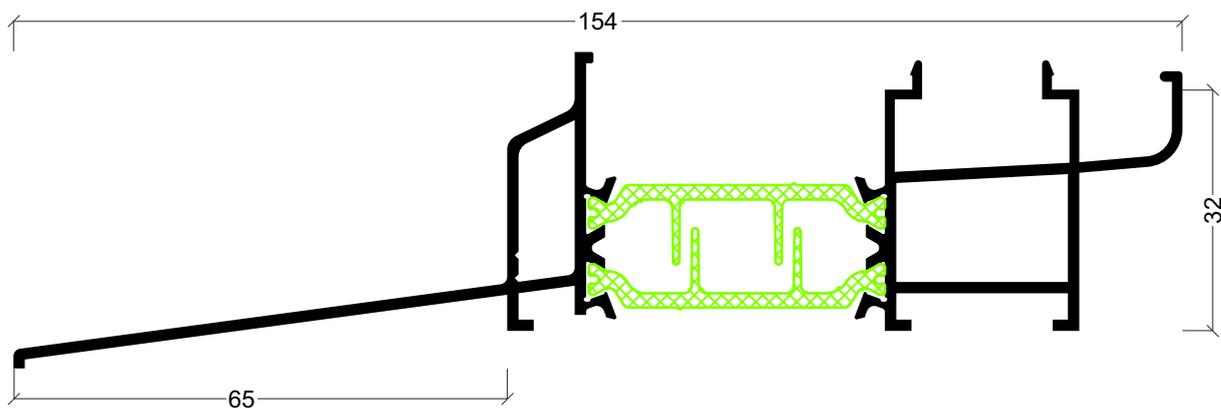

AKi-50
Soleira condensação com pingadeira

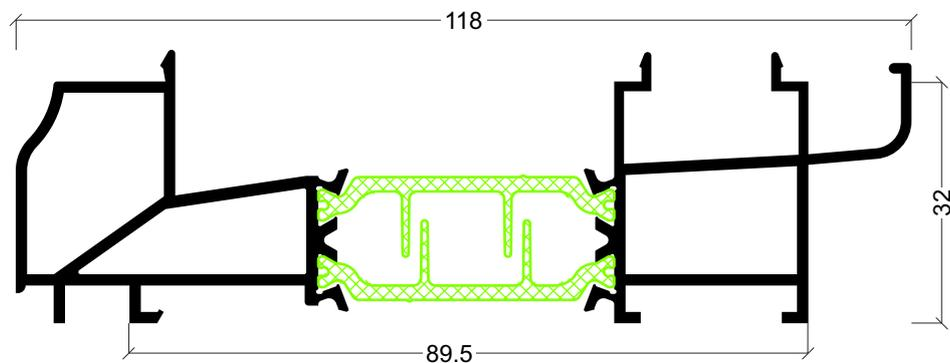

AKi-56
Soleira condensação tradição



AXi-91
Complemento remate

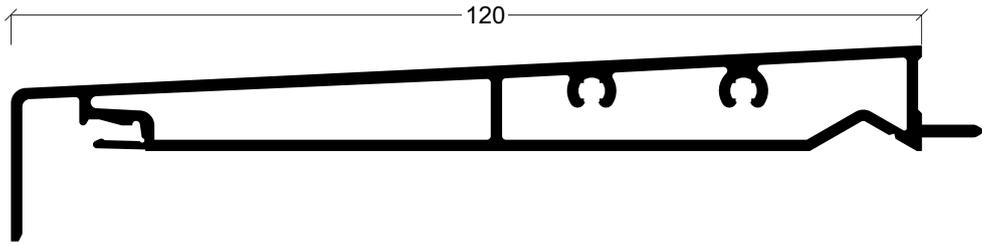

AXi-74
Remate soleira

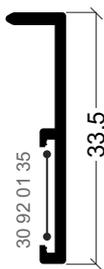

AXi-88
Complemento remate

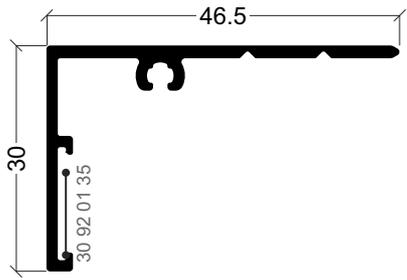

AXi-80
Remate

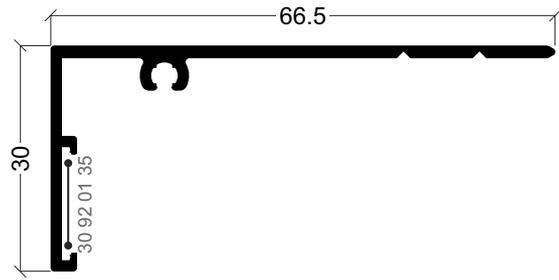

AXi-73
Remate

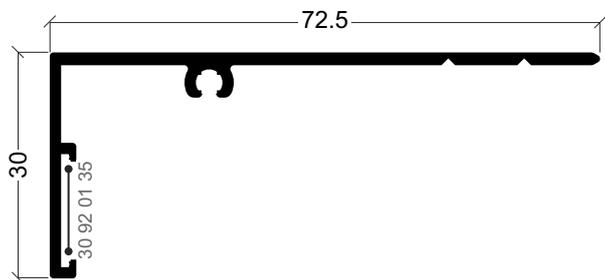

AXi-83
Remate

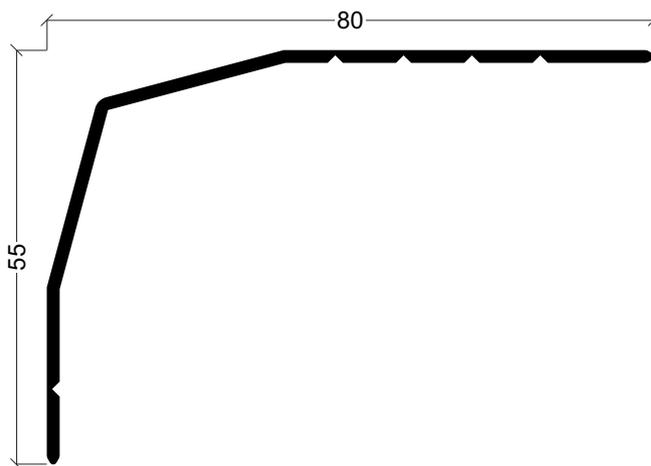

AXi-72
Remate

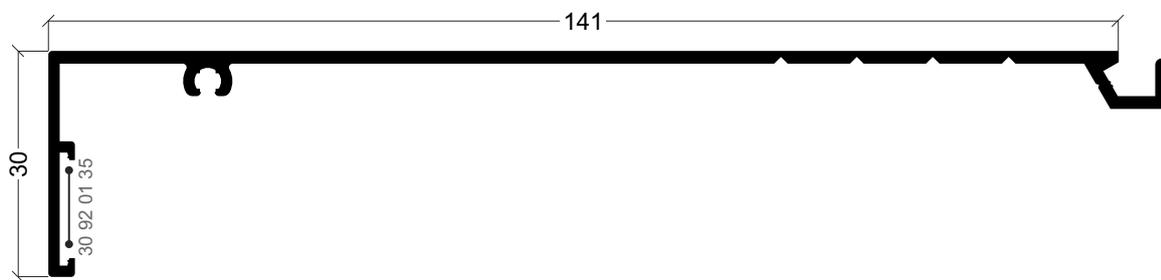

S-09
Remate

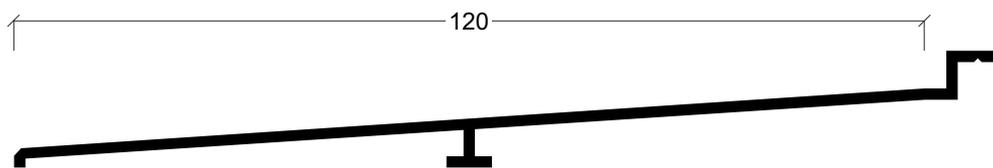

AZ-24
Pingadeira 120 mm

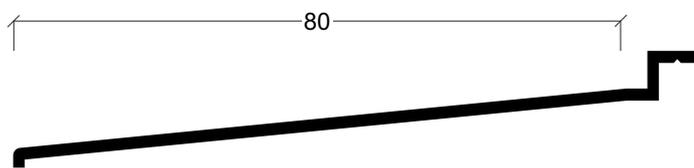

AZ-30
Pingadeira 120 mm

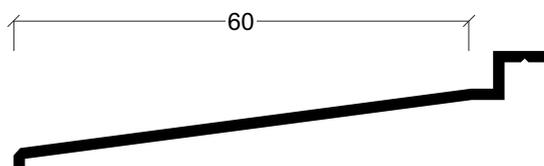

AZ-23
Pingadeira 120 mm

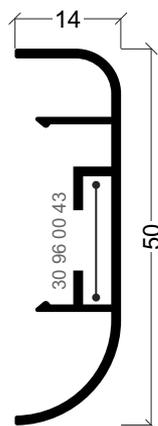

ARi-27
Tapa juntas

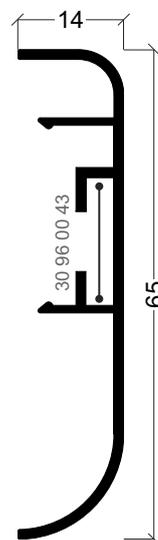

ARi-34
Tapa juntas

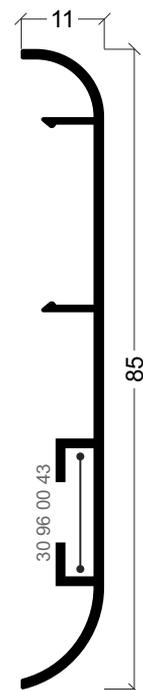

ARi-28
Tapa juntas

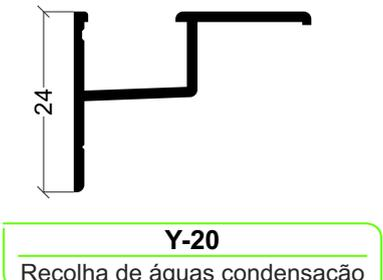
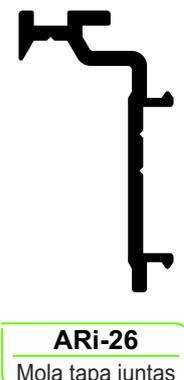
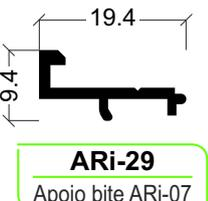
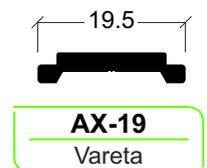
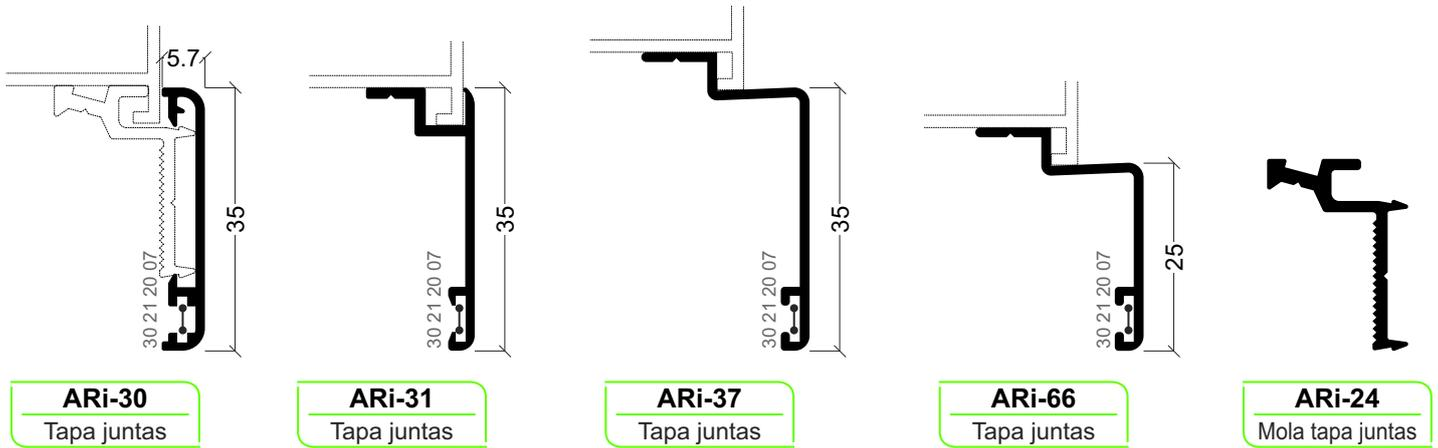

106

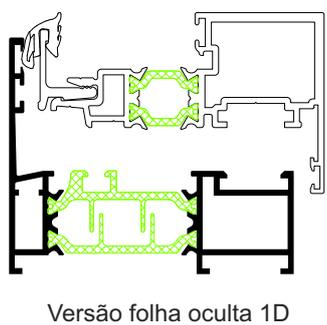
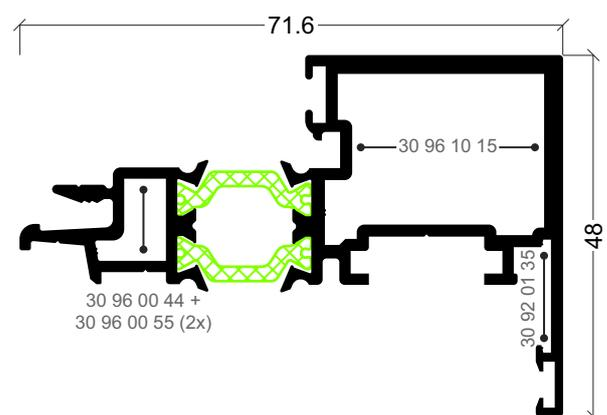
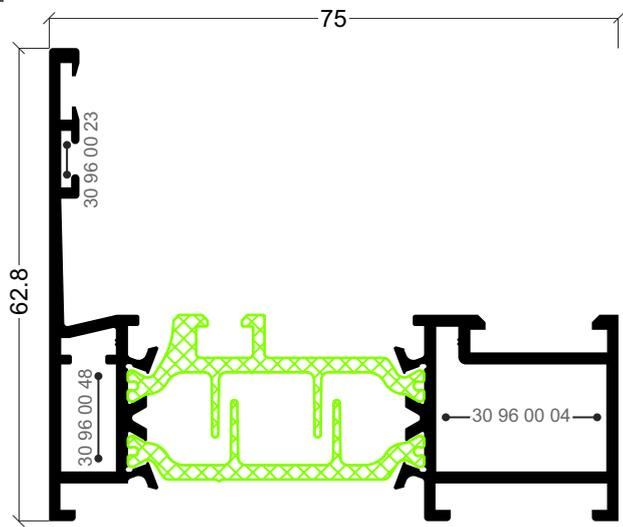

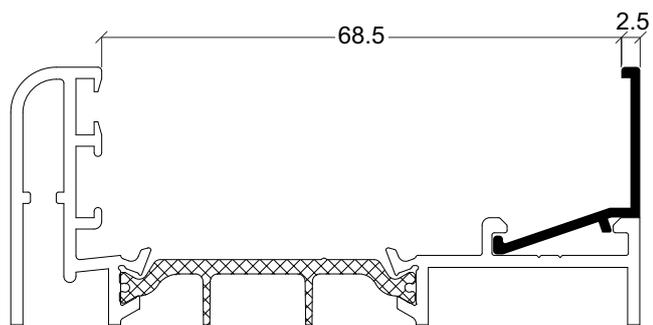

AX-69

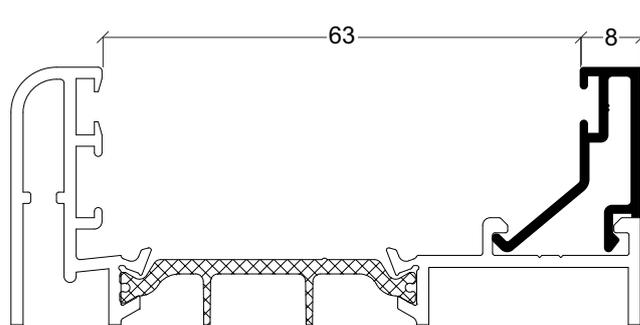

AX-74

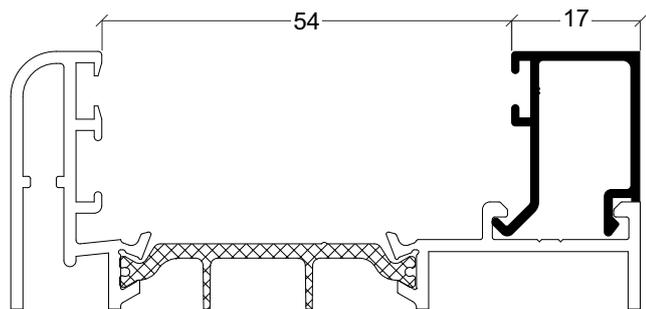

AX-46

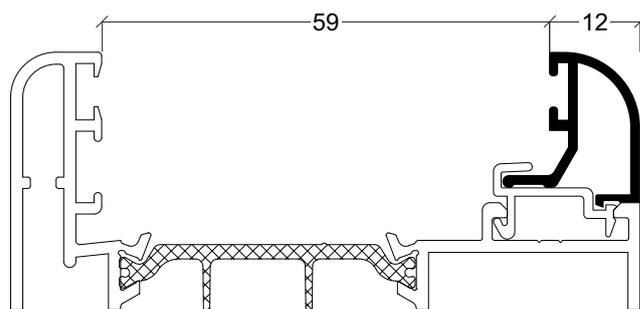

AX-37

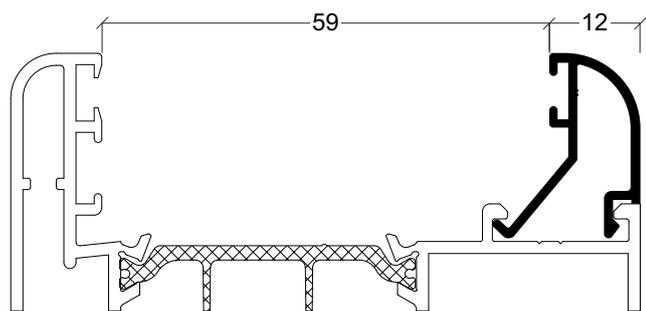

AZ-08

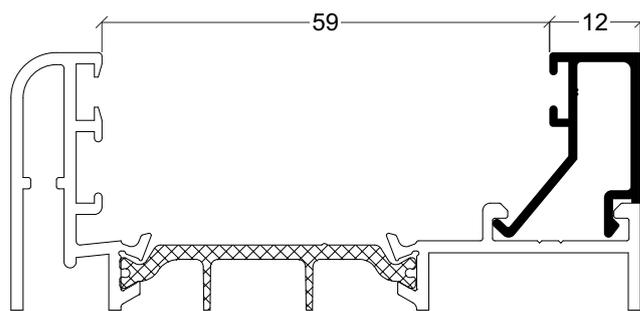

AX-36

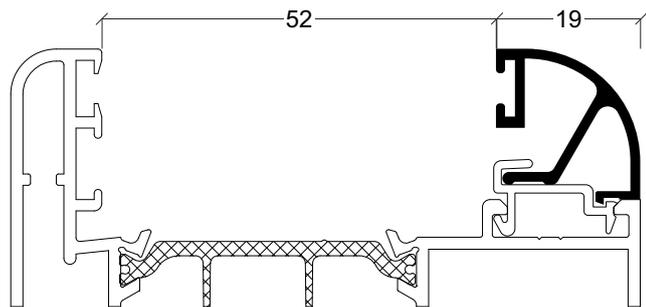

AX-30

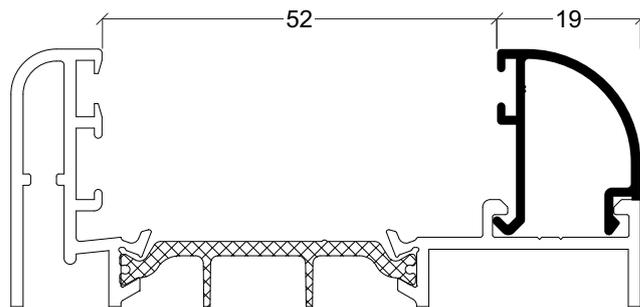

AZ-07

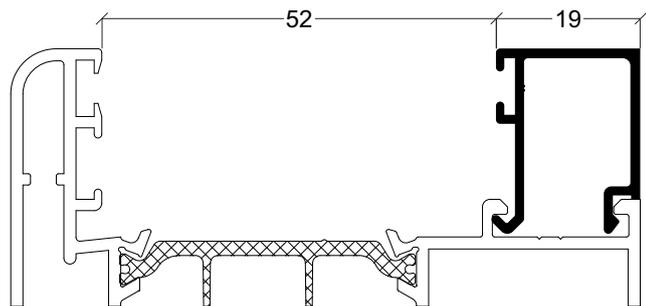

AX-35

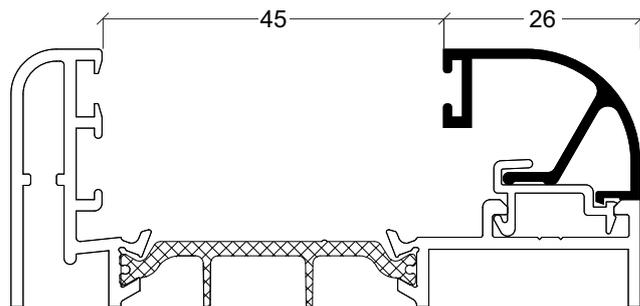

AX-29

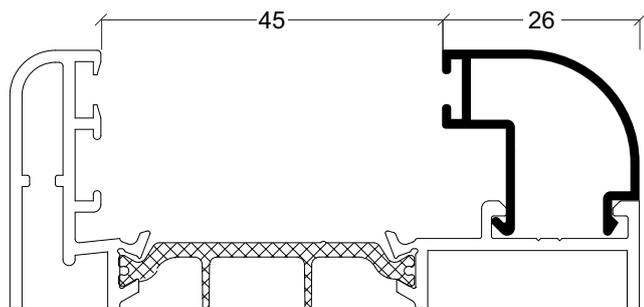

AZ-06

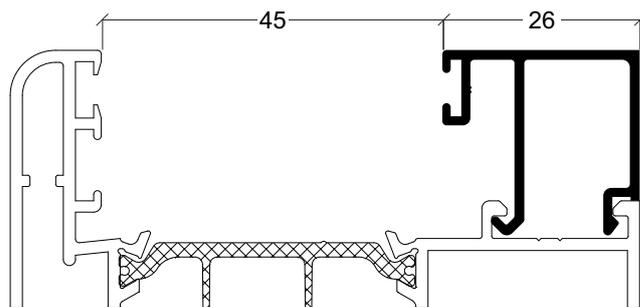

AX-31

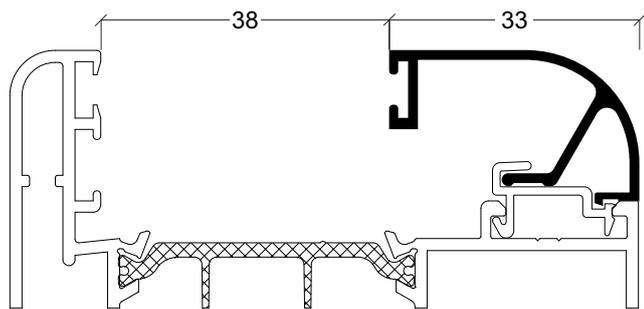

AX-39

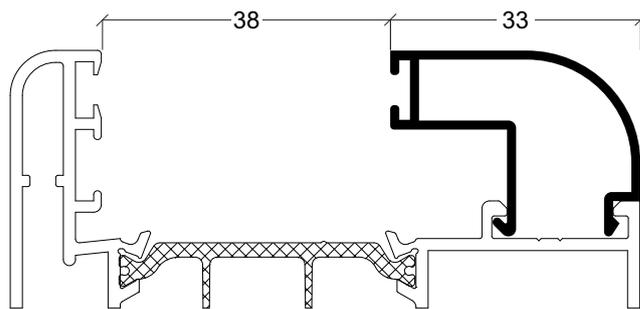

AZ-28

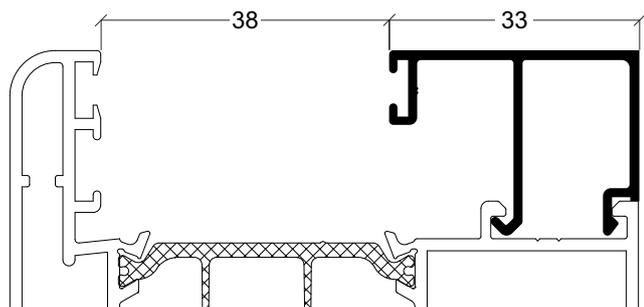

AX-34

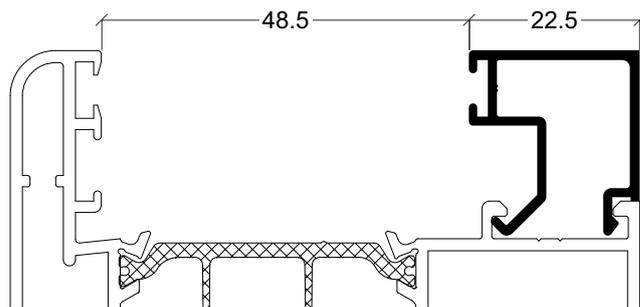

AX-78

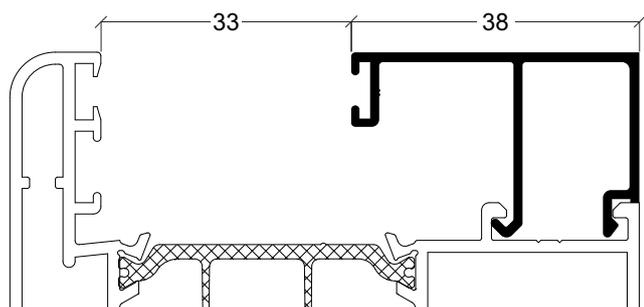

AX-32

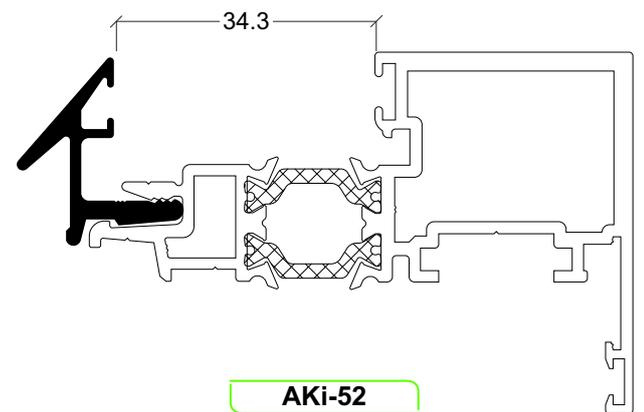

AKi-52

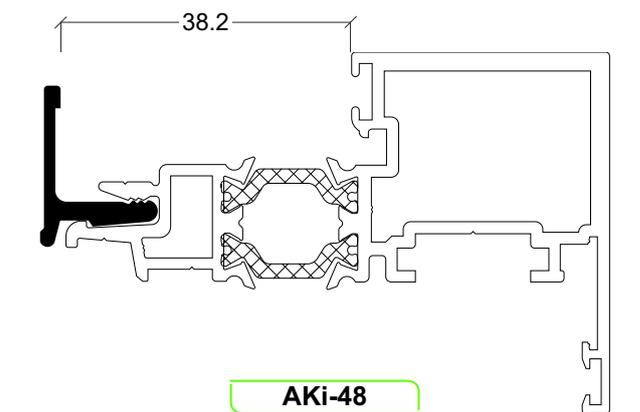

AKi-48

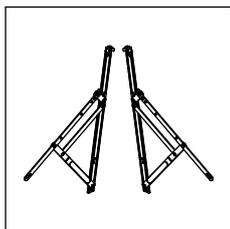

30 00 95 71

Compasso projectante
deslizante até 100 kg/folha

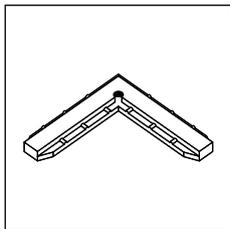

30 21 20 07

Esquadro de
alinhamento

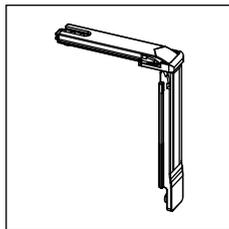

30 90 20 42

Ângulo de reenvio

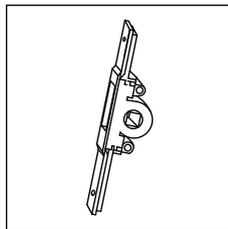

30 90 20 44

Transmissão para
abertura exterior

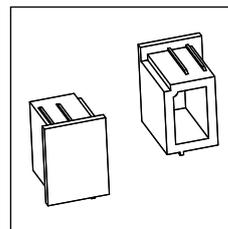

30 91 21 20

Jogo topos condensação
para Y-20

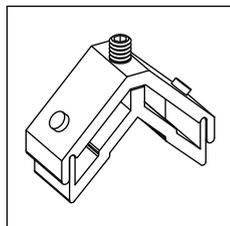

30 91 40 15

Esquadro aro fixo AKi-38

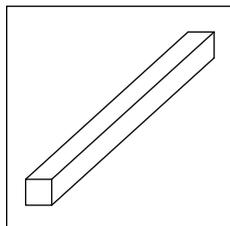

30 91 41 23

Perno 7x131 mm

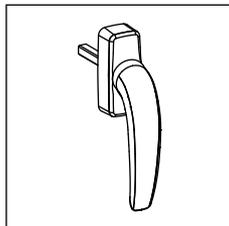

30 91 41 47/48

Cremone pivotante especial
branco/preto

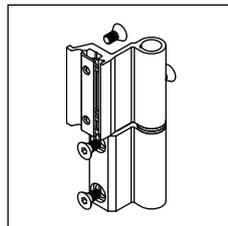

30 92 00 20/21

Dobradiça C.E. branco/
preto

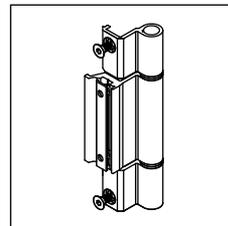

30 92 00 26/27/28

Dobradiça três nós
(bruto/branco/preto)

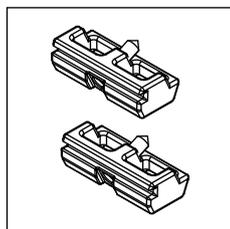

30 92 00 50

Contra-fecho

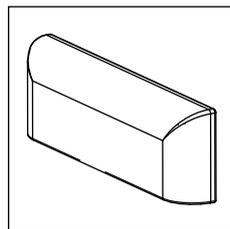

30 92 01 00/01

Goteiras preto/branco

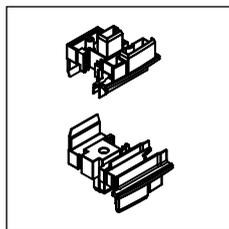

30 92 01 14

Conjunto topos inversor
com furo AKi folha oculta

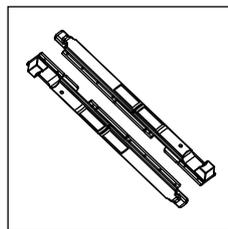

30 92 01 20

Jogo fecho C.E.

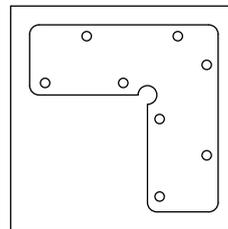

30 92 01 35

Esquadro alinhamento
móvel

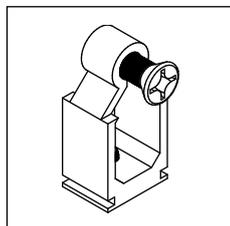

30 92 01 40

União topos janela

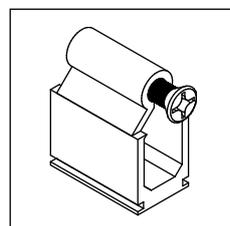

30 92 01 50

União topos porta

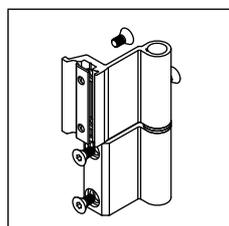

30 92 01 70/80

Dobradiça 3 folhas
branco/preto

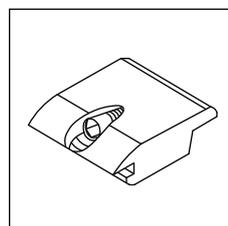

30 92 02 60

Apoio da folha

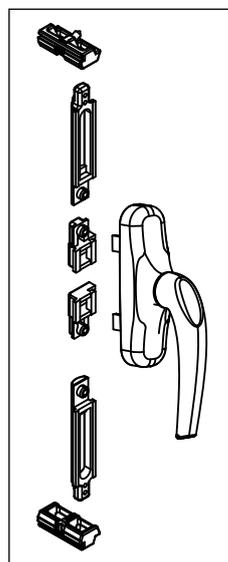

30 92 03 10/11

Kit cremone branco/preto

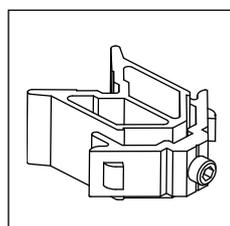

30 92 03 90

Esquadro porta

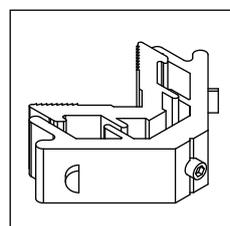

30 92 04 25

Esquadro AKi-80

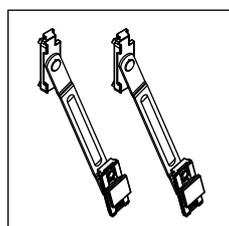

30 92 04 75

Jogo compasso
basculante

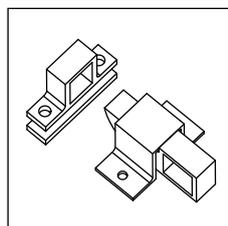

30 92 04 76/77

Fecho clack (branco/
preto)

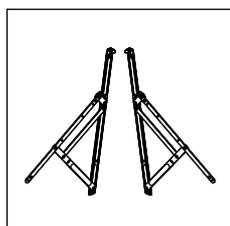

30 92 04 80

Compasso projectante
deslizante até 50 kg/folha

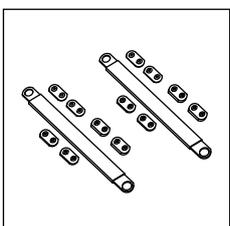

30 92 04 85

Jogo compasso

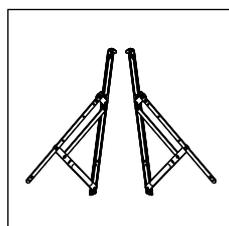

30 92 04 90

Compasso projectante
deslizante até 70 kg/folha

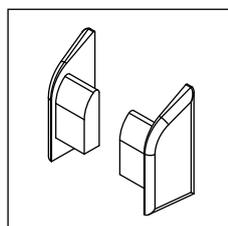

30 92 05 00

Jogo topos AZ-60

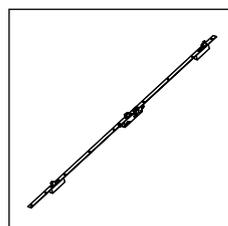

30 92 05 10

Fechadura 3 pontos
(35 mm)

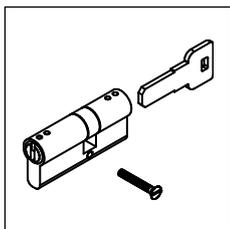

30 92 05 55

Canhão fechadura

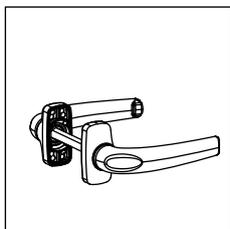

30 92 05 60/61

Puxador duplo branco/
preto

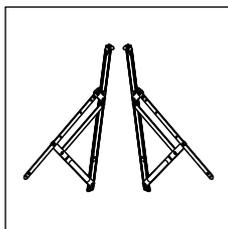

30 92 06 00

Compasso projectante
deslizante até 20 kg/folha

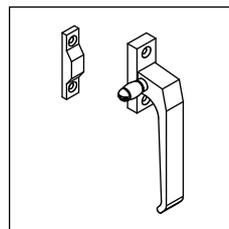

30 92 06 10/11

Cremone de lingueta
branco/preto

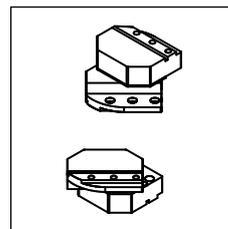

30 92 07 12

Jogo pivotante vertical
especial AKi preto (130Kg)

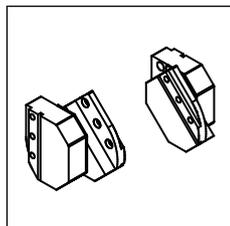

30 92 07 13

Jogo pivotante horizontal
especial AKi preto (130Kg)

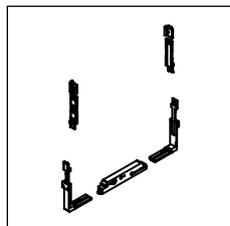

30 92 07 16

Fecho perimetral
pivotante especial

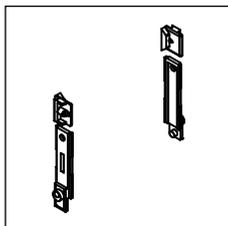

30 92 07 17

Fecho suplementar
pivotante especial

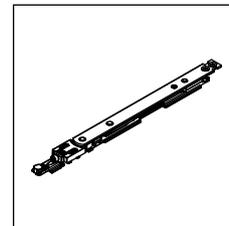

30 92 12 11/12

Compasso oscilo
400/500



30 92 12 13

Compasso suplementar
AKi

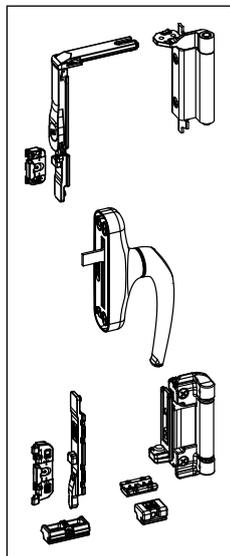

30 92 12 20/21

Kit oscilobatente branco/
preto

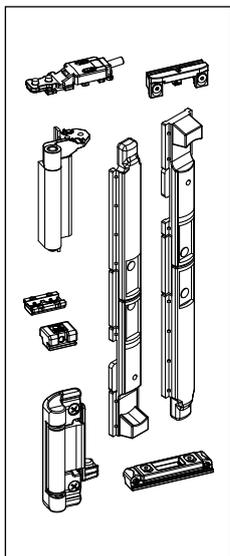

30 92 12 24/25

Kit 2ª folha OB branco/
preto

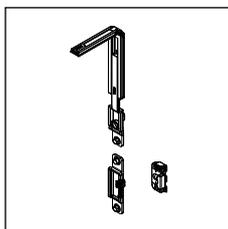

30 92 12 45

Kit fecho 3º ponto AKi

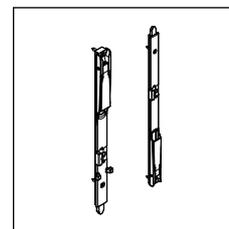

30 92 12 50

Jogo passadores AKi
(Zamack)

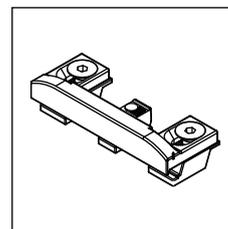

30 92 12 55

Ponto de fecho regulável

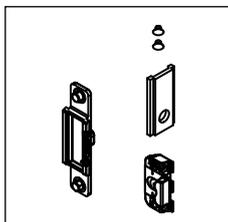

30 92 22 43

Ponto fecho O.B.
suplementar

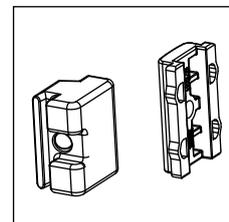

30 95 52 15

Ponto de fecho
suplementar

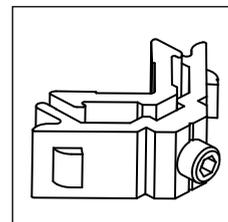

30 96 00 04

Esquadro janela

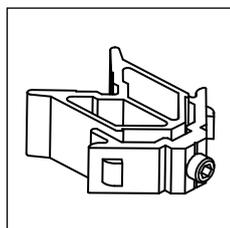

30 96 00 05

Esquadro aro fixo porta

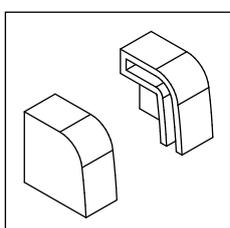

30 96 00 12

Jogo topos condensação

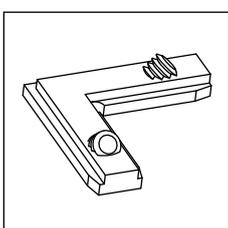

30 96 00 15

Esquadro alinhamento
móvel

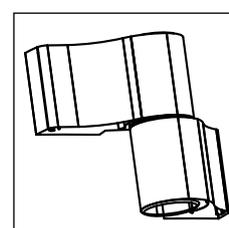

30 96 00 16/20

Dobradiça lisa branco/
preto

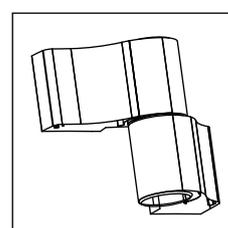

30 96 00 17/21

Dobradiça com ressalto
branco/preto

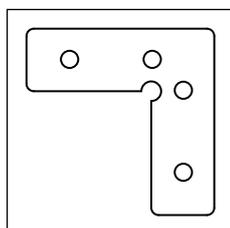

30 96 00 22

Esquadro alinhamento
especial

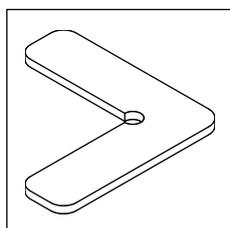

30 96 00 23

Esquadro alinhamento
aro fixo

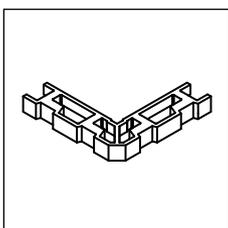

30 96 00 25

Esquadro exterior aro
fixo

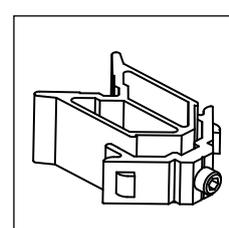

30 96 00 36

Esquadro aro móvel
porta

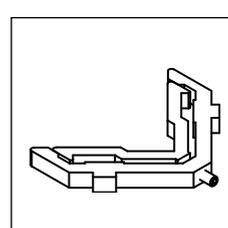

30 96 00 38

Esquadro alinhamento
móvel janela

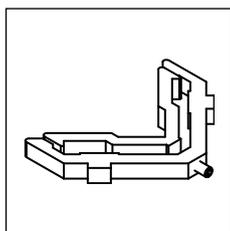

30 96 00 39
Esquadro alinhamento
aro fixo janela

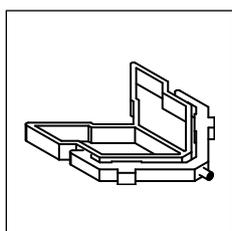

30 96 00 40
Esquadro alinhamento
aro fixo porta

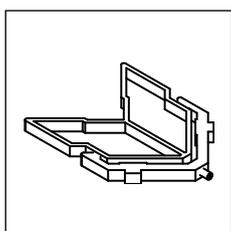

30 96 00 41
Esquadro alinhamento
aro móvel porta

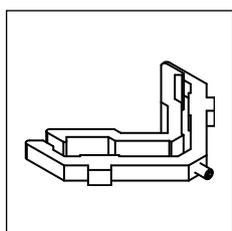

30 96 00 42
Esquadro perfil AKi-07

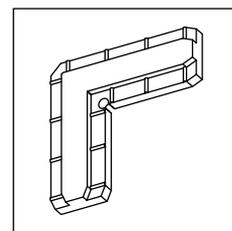

30 96 00 43
Esquadro alinhamento

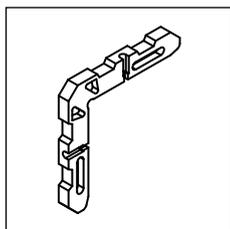

30 96 00 44
Esquadro exterior AKi-78

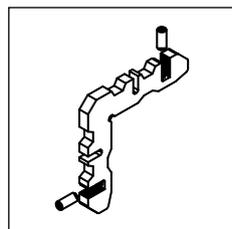

30 96 00 45
Esquadro de alinhamento
5.2x14 com parafusos

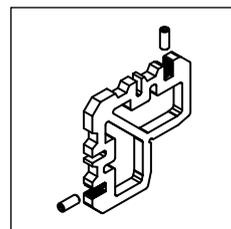

30 96 00 46
Esquadro de alinhamento
5.2x36 com parafusos

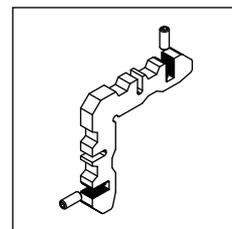

30 96 00 48
Esquadro de alinhamento
7x14 c/ parafusos

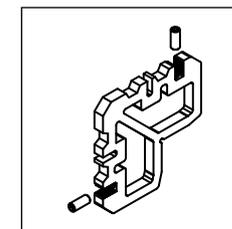

30 96 00 49
Esquadro de alinhamento
aro fixo com parafusos

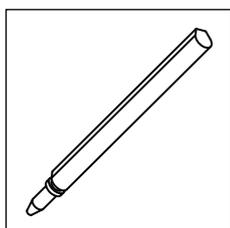

30 96 00 55
Perno alternativo para
fixação de esquadro

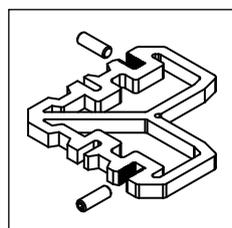

30 96 00 60
Esquadro de alinhamento
5.2x31.6 com parafusos

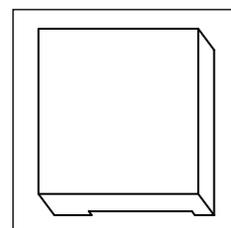

30 96 10 01
Calço para vidro

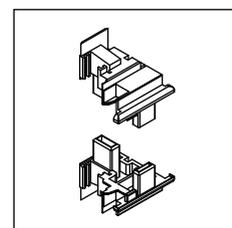

30 96 10 08
Jogo topos inversor
AKi-04

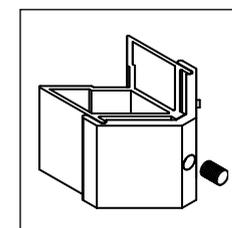

30 96 10 15
Esquadro interior AKi-78

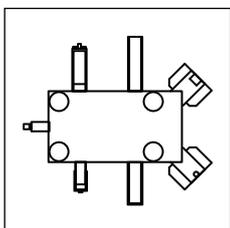

33 20 70 03
Cunho AKi folha oculta
3D

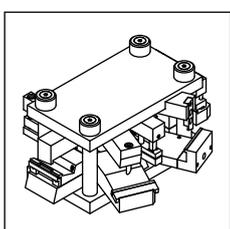

33 96 79 99
Cunho C.E.

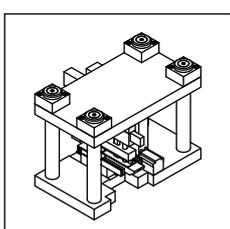

33 96 87 99
Cunho esquadro interior
e exterior ARi/AKi

Referência	Desenho	Descrição
30 00 95 15		Junta vedação interior curta
30 20 26 03		Junta vedação vidro
30 20 70 03		Pelúcia remate porta 11x12 mm
30 92 04 70		Espuma isolante
30 93 00 60		Vedante exterior de vidro (opcional)
30 93 00 61		Junta vedação exterior vidro 2 mm
30 93 00 62		Junta plana para vidro
30 93 00 65		Junta interior para vidro (5 mm)
30 93 00 66		Junta interior para vidro (4 mm)
30 93 00 67		Junta interior para vidro (2 mm)
30 93 00 68		Junta interior para vidro (6/7 mm)
30 93 00 69		Junta interior para vidro (8/9 mm)
30 93 00 70		Vedante interior de vidro (opcional)
30 93 00 80		Junta de vedação inferior AKi-42
30 93 00 82		Junta vedação inferior
30 93 01 20		Junta interior
30 93 01 30		Junta exterior (abertura exterior/projectante)
30 95 00 10		Pelúcia 7x9 mm
30 96 00 02		Junta exterior
30 96 00 18		Junta interior (abertura projectante/deslizante)
30 96 00 27		Junta exterior folha oculta 1D
30 96 10 04		Junta central
30 96 10 05		Junta vedação AKi - folha oculta 3D
30 96 10 09		Junta central AKi-09/AKi-25
30 96 10 12		Junta isolante

Janela 1 folha abrir e oscilo-batente

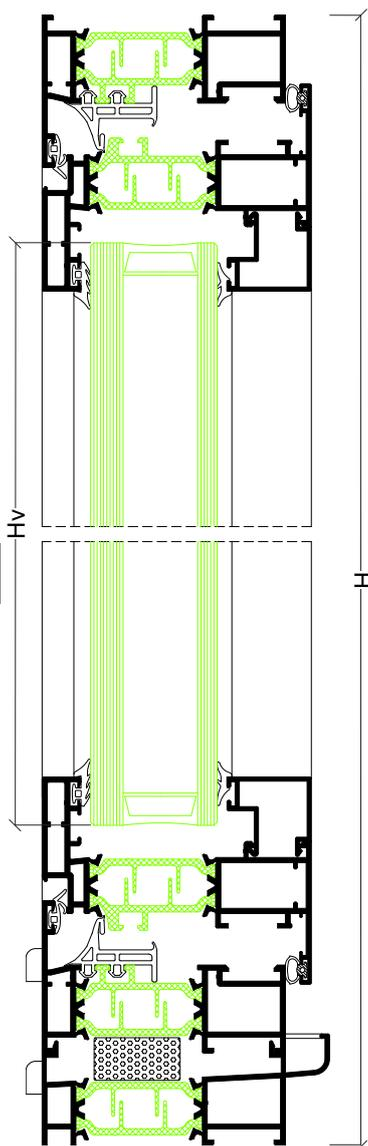
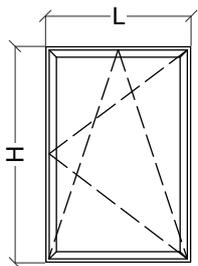

Perfis

Desenho	Ref	Descrição	Corte	Quant	Medida
	AKi-03	Aro fixo		2	L
				2	H-28.5 mm
	AKi-61	Aro móvel		2	L-43 mm
				2	H-71.5 mm
	---	Bíte		2	L-132 mm
				2	H-200.5 mm
	CT-11	Soleira condensação		1	L
	AX-19	Vareta		1+1	Apro. H+L

Acessórios e Juntas

Referência	Descrição	Quantidade	
		Abrir	Oscilo-batente
30 92 00 20	Dobradiças C.E.	2	---
30 92 01 00	Goteiras	4	4
30 92 12 XX	Compasso O.B.	---	1
30 92 12 20	Kit oscilo-batente	---	1
30 92 02 60	Apoio da folha	1	---
30 92 03 10	Kit cremone	1	---
30 96 00 04	Esquadro janela	8	8
30 96 00 48	Esquadro alinhamento aro fixo	4	4
30 96 00 12	Jogo topos condensação	1	1
30 96 00 15	Esquadro alinhamento móvel	4	4
30 96 00 22	Esquadro alinhamento móvel	4	4
30 96 00 45	Esquadro alinhamento exterior móvel	4	4
30 96 10 01	Calço para vidro	4	4
30 92 04 70	Espuma isolante	L	
30 96 00 02	Junta exterior	2L+2H	
30 96 10 04	Junta central	2L+2H	
30 93 01 20	Junta interior	2L+2H	
---	Junta exterior vidro	2L+2H	
---	Junta interior vidro	2L+2H	

Vidro

Hv = H-174 mm	Lv = L-146 mm
---------------	---------------

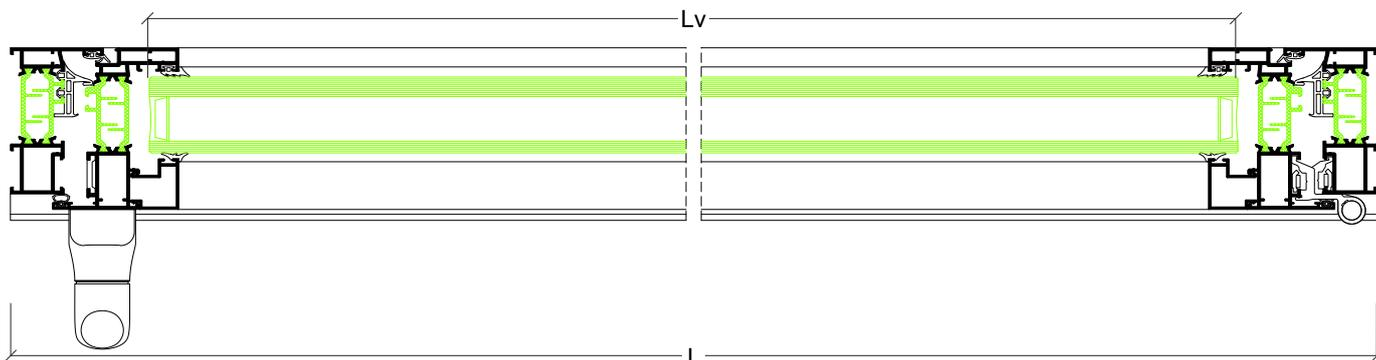

Janela 2 folhas abrir e oscilo-batente

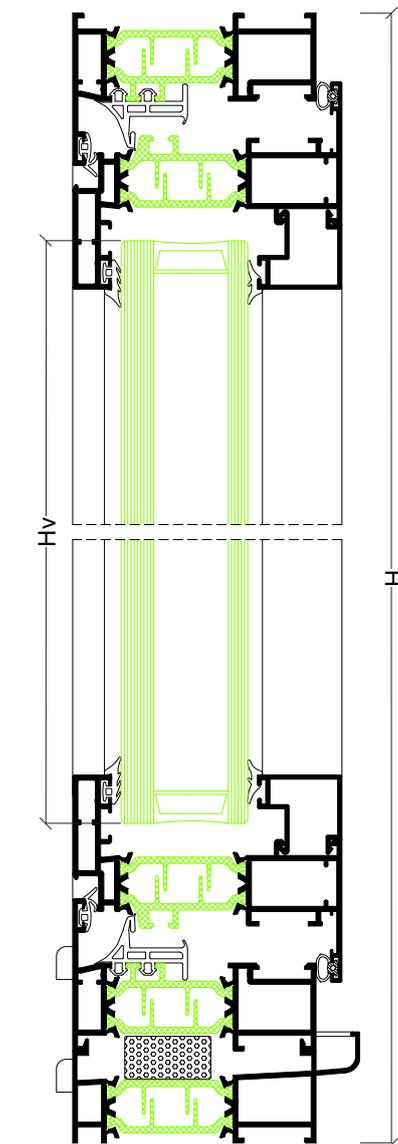
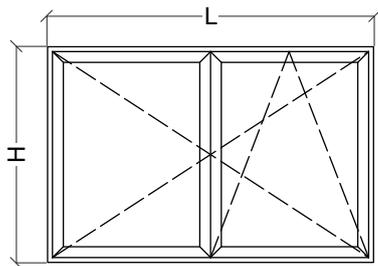

Perfis

Desenho	Ref	Descrição	Corte	Quant	Medida
	AKi-03	Aro fixo		2	L
				2	H-28.5 mm
	AKi-61	Aro móvel		2	L/2-24 mm
				2	H-71.5 mm
	AKi-04	Inversor		1	H-139.5 mm
	---	Bite		4	L/2-113 mm
				4	H-200.5 mm
	CT-11	Soleira condensação		1	L
	AX-19	Vareta		1+1	Apro. H+L

Acessórios e Juntas

Referência	Descrição	Quantidade	
		Abrir	Oscilo-batente
30 92 00 20	Dobradiças C.E.	4	---
30 92 01 00	Goteiras	4	4
30 92 01 20	Jogo fecho C.E.	1	---
30 92 12 XX	Compasso O.B.	---	1
30 92 12 20	Kit oscilo-batente	---	1
30 92 12 24	Kit 2ª folha oscilo-batente	---	1
30 92 02 60	Apoio da folha	1	---
30 92 03 10	Kit cremone	1	---
30 96 00 04	Esquadro janela	12	12
30 96 00 48	Esquadro alinhamento aro fixo	8	8
30 96 10 08	Jogo topos inversor	1	1
30 96 00 12	Jogo topos condensação	1	1
30 96 00 15	Esquadro alinhamento móvel	8	8
30 96 00 22	Esquadro alinhamento móvel	8	8
30 96 00 45	Esquadro alinhamento exterior móvel	4	4
30 96 10 01	Calço para vidro	4	4
30 92 04 70	Espuma isolante	L	
30 96 00 02	Junta exterior	2L+4H	
30 96 10 04	Junta central	2L+3H	
30 93 01 20	Junta interior	2L+4H	
---	Junta exterior vidro	2L+2H	
---	Junta interior vidro	2L+2H	

113

Vidro

Hv = H-174 mm	Lv = L/2-127 mm
---------------	-----------------

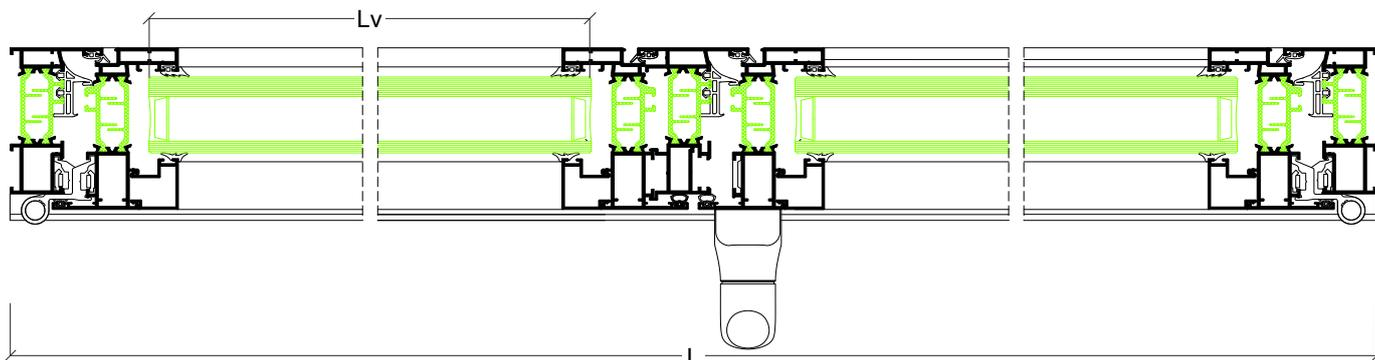

Janela 1 folha projectante deslizante

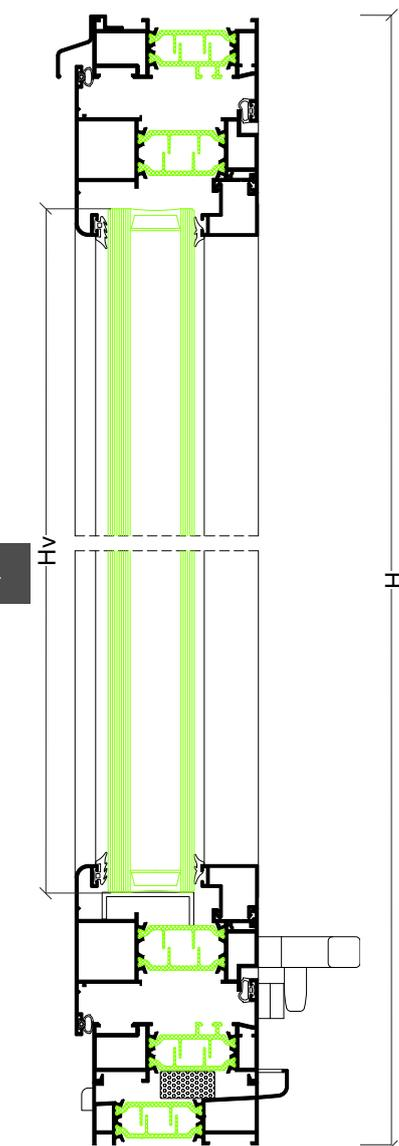
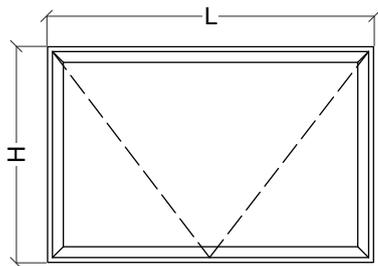

Perfis

Desenho	Ref	Descrição	Corte	Quant	Medida
	AKi-03	Aro fixo		2	L
				2	H-28.5 mm
	AKi-07	Aro móvel abertura projectante deslizante		2	L-43 mm
				2	H-71.5 mm
	---	Bite		4	L-159 mm
				4	H-227.5 mm
	AXi-45	Pingadeira superior		1	L
	AXi-32	Complemento abertura projectante		2	segundo medida compasso
	ARi-29	Apoio bite		2	L-140 mm
				2	H-168.5 mm
	CT-11	Soleira condensação		1	L

Acessórios e Juntas

Referência	Descrição	Quantidade
30 92 01 00	Goteiras	2
30 92 04 10	Esquadro janela	4
30 92 04 90	Jogo compasso projectante deslizante 550	1
30 92 06 10	Cremona de lingueta	2
30 92 04 10	Esquadro janela abertura exterior	4
30 96 00 12	Jogo topos condensação	1
30 96 00 48	Esquadro alinhamento aro fixo	4
30 96 00 42	Esquadro alinhamento interno móvel	4
30 92 04 70	Espuma isolante	L
30 93 01 20	Junta exterior	2L+2H
30 96 00 18	Junta interior projectante deslizante	2L+2H
---	Junta exterior vidro	2L+2H
---	Junta interior vidro	2L+2H

Vidro

Hv = H-201 mm	Lv = L-173 mm
---------------	---------------

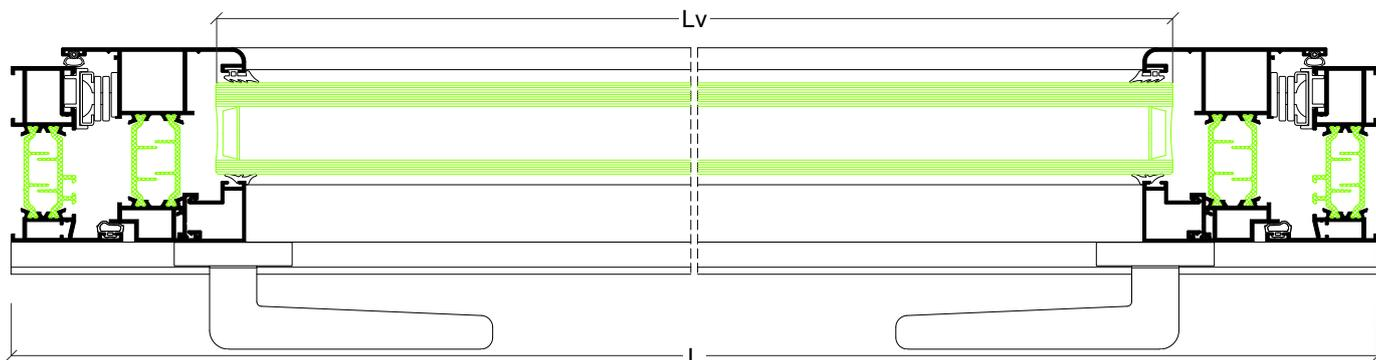

Janela pivotante horizontal

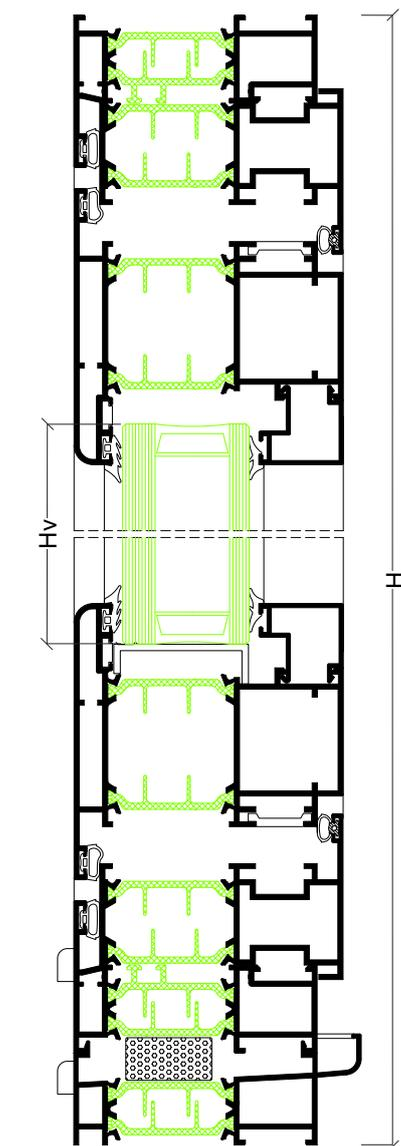
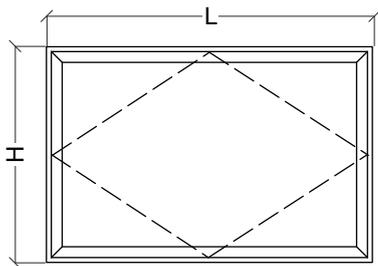

Perfis

Desenho	Ref	Descrição	Corte	Quant	Medida
	AKi-03	Aro fixo		2	L
				2	H-28.5 mm
	AKi-25	Aro móvel abertura exterior		2	L-107 mm
				2	H-135.5 mm
	AKi-14	Inversor pivotante superior		1	L-46 mm
				2	H/2-23 mm
	AKi-14	Inversor pivotante inferior		1	L-46 mm
				2	H/2-51.5 mm
	---	Bite		2	L-239 mm
				2	H-307.5 mm
	CT-11	Soleira condensação		1	L
	AX-19	Vareta		1+1	L+H
				1+1	L+H

Acessórios e Juntas

Referência	Descrição	Quantidade
30 92 01 00	Goteiras	4
30 94 50 10	Esquadro inversor	4
30 96 00 04	Esquadro janela	4
30 96 00 05	Esquadro móvel	4
30 96 00 48	Esquadro alinhamento exterior janela	4
30 96 00 12	Jogo topos condensação	1
30 92 07 13	Jogo pivotante horizontal	1
30 92 07 16	Fecho perimetral pivotante	1
30 96 00 15	Esquadro alinhamento móvel	4
30 91 41 48	Cremones	1
30 92 04 70	Espuma isolante	L
30 96 00 18	Junta exterior	4L+4H
30 93 01 20	Junta interior	2L+2H
---	Junta exterior vidro	2L+2H
---	Junta interior vidro	2L+2H

115

Vidro

Hv = H-281 mm	Lv = L-253 mm
---------------	---------------

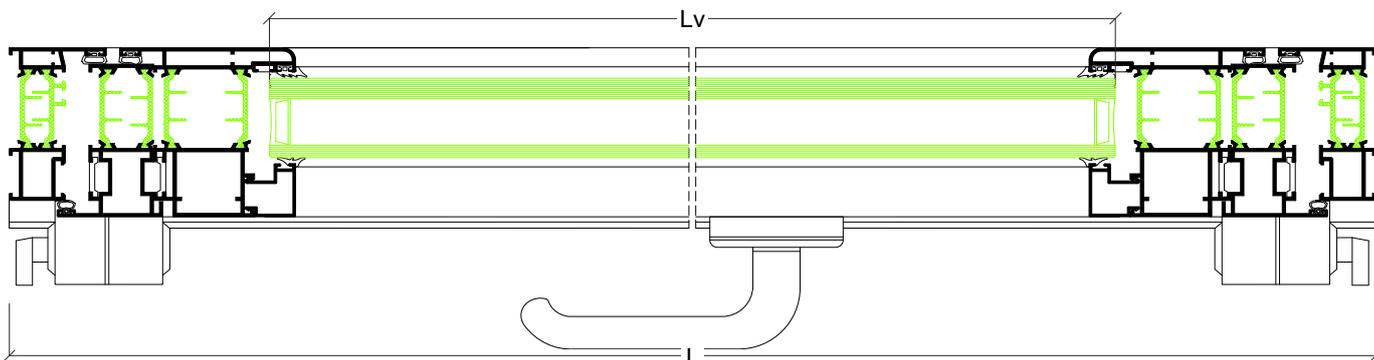

Porta 1 folha

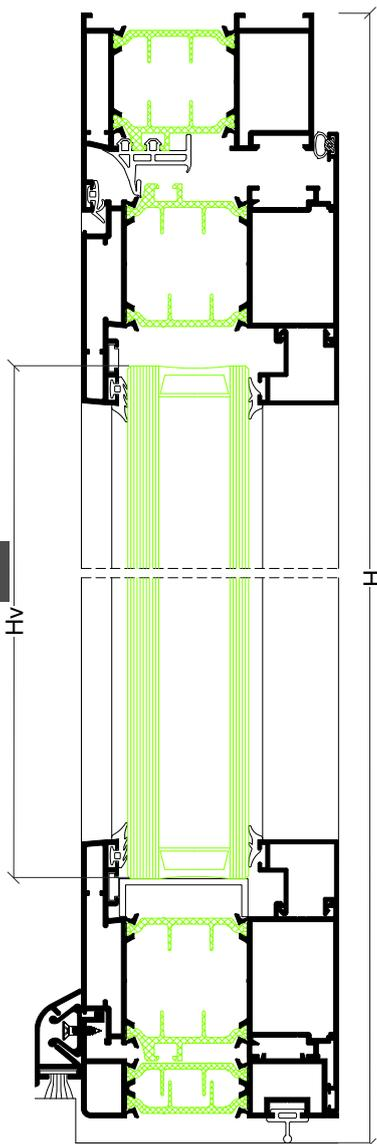
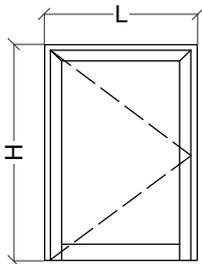

Perfis

Desenho	Ref	Descrição	Corte	Quant	Medida
	AKi-08	Aro fixo		1	L
				2	H
	AKi-36	Aro móvel		2	L-78 mm
				2	H-46 mm
	AKi-23	Almofada		1	L-147 mm
	---	Bite		4	L-216 mm
				4	H-226 mm
	AZ-60	Pingadeira		1	L-148 mm

Acessórios e Juntas

Referência	Descrição	Quantidade
30 92 00 20	Dobradiças C.E.	3
30 92 01 35	Esquadro alinhamento móvel	4
30 92 05 10	Fechadura 3 pontos	1
30 92 05 55	Canhão fechadura	1
30 92 05 60	Puxador duplo	1
30 96 00 05	Esquadro aro porta	2
30 96 00 15	Esquadro alinhamento móvel	4
30 96 00 36	Esquadro móvel porta	4
30 96 00 46	Esquadro alinhamento aro móvel porta	4
30 96 00 49	Esquadro alinhamento aro fixo	2
31 03 40 00	Mola para pingadeira	A cada 200 mm
30 92 05 00	Jogo topos AZ-60	1
30 96 10 01	Calço para vidro	4
30 93 00 80	Junta inferior	L
30 96 00 02	Junta exterior	L+2H
30 96 10 04	Junta central	L+2H
30 93 01 20	Junta interior	L+2H
---	Junta exterior vidro	2L+2H
---	Junta interior vidro	2L+2H

Vidro

Hv = H-200 mm	Lv = L-230 mm
---------------	---------------

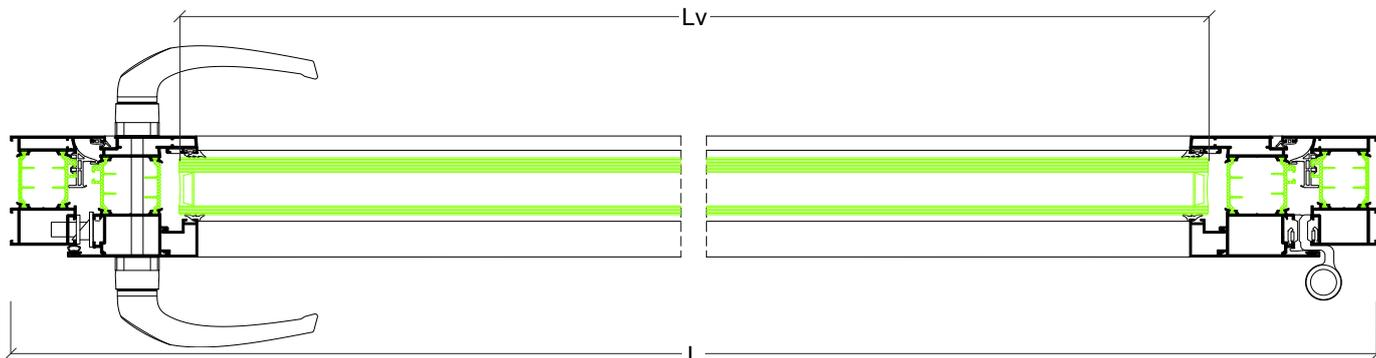

Porta 2 folhas

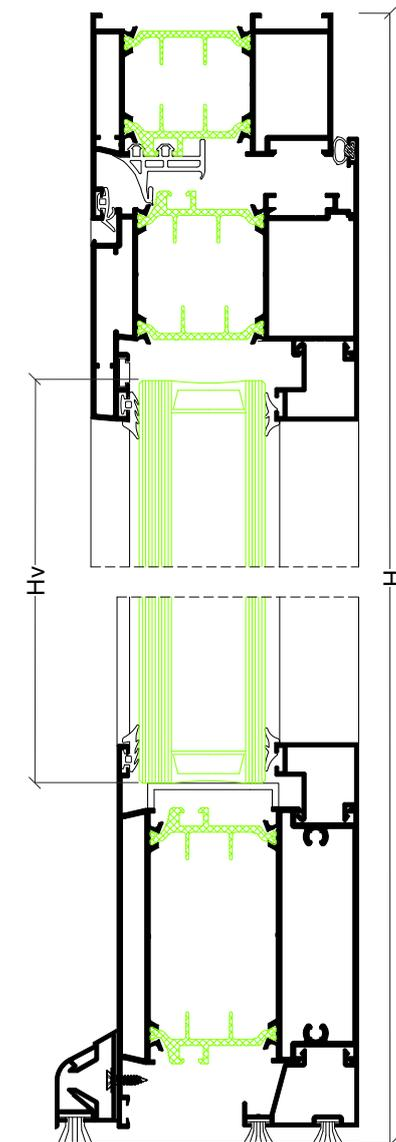
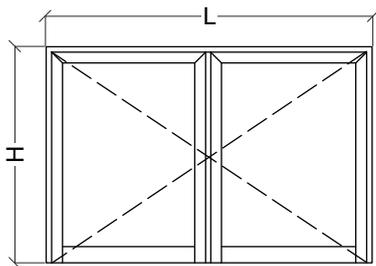

Perfis

Desenho	Ref	Descrição	Corte	Quant	Medida
	AKi-08	Aro fixo		1	L
				2	H
	AKi-10	Aro móvel		2	L/2-41.5 mm
				4	H-44 mm
	AKi-04	Inversor		1	H-78 mm
	AKi-12	Travessa		1	L/2-169.5 mm
	---	Bite		8	L-179 mm
				4	H-253 mm
	AZ-60	Pingadeira		1	L/2-112.5 mm
				1	L/2-43 mm
	AZ-61	Suplemento para pingadeira		2	L/2-219.5 mm
	AX-15	Bite remate		2	L/2-160.5 mm

Acessórios e Juntas

Referência	Descrição	Quantidade
30 92 00 20	Dobradiças C.E.	6
30 92 01 20	Jogo fecho C.E.	1
30 92 01 35	Esquadro alinhamento móvel	8
30 92 05 10	Fechadura 3 pontos	1
30 92 05 55	Canhão fechadura	1
30 92 05 60	Puxador duplo	1
30 96 00 05	Esquadro aro porta	2
30 96 10 08	Jogo topos inversor	1
30 96 00 15	Esquadro alinhamento móvel	8
30 96 00 36	Esquadro móvel porta	4
30 96 00 46	Esquadro alinhamento aro móvel porta	8
30 96 00 49	Esquadro alinhamento aro fixo	2
30 95 00 10	Pelúcia 7x9 mm	2L
30 95 05 00	Jogo topos AZ-60	1
30 96 10 01	Calço para vidro	8
30 96 00 02	Junta exterior	L+4H
30 96 10 04	Junta central	L+3H
30 93 01 20	Junta interior	L+4H
---	Junta exterior vidro	2L+4H
---	Junta interior vidro	2L+4H

Vidro

Hv = H-227 mm	Lv = L/2-193 mm
---------------	-----------------

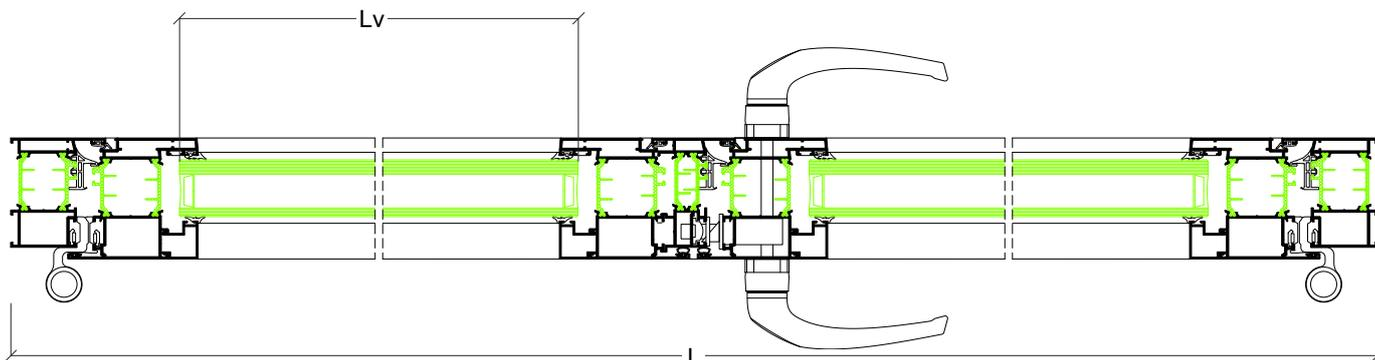

Porta 2 folhas abertura exterior

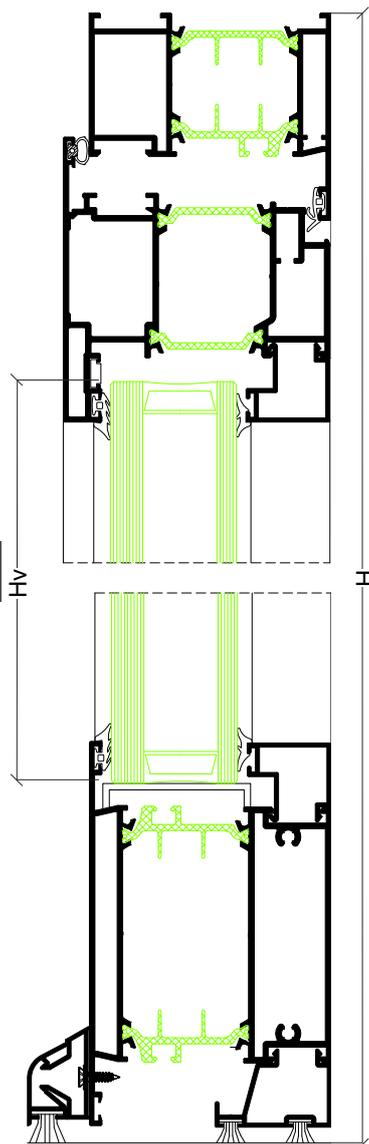
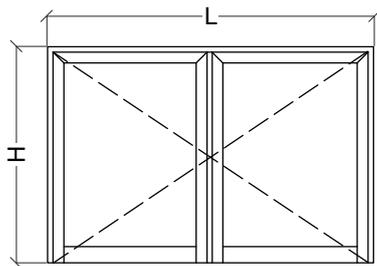

Perfis

Desenho	Ref	Descrição	Corte	Quant	Medida
	AKi-08	Aro fixo		1	L
				2	H
	AKi-72	Aro móvel abertura exterior		2	L/2-41.5 mm
				4	H-44 mm
	AKi-04	Inversor		1	H-78 mm
	AKi-12	Travessa		1	L/2-169.5 mm
	AX-15	Bite remate		2	L/2-160.5 mm
	---	Bite		4	L/2-179 mm
				4	H-253 mm
	AZ-60	Pingadeira		1	L/2-112.5 mm
				1	L/2-43 mm
	AZ-61	Suplemento para pingadeira		2	L/2-219.5 mm

Acessórios e Juntas

Referência	Descrição	Quantidade
30 92 01 20	Jogo fecho C.E.	1
30 92 05 10	Fechadura 3 pontos	1
30 92 05 55	Canhão fechadura	1
30 92 05 60	Puxador duplo	1
30 96 00 05	Esquadro porta	2
30 96 10 08	Jogo topos inversor	1
30 92 00 20	Dobradiça C.E.	6
30 95 00 10	Pelúcia 7x9 mm	2L
30 95 05 00	Jogo topos AZ-60	1
30 92 03 90	Esquadro móvel exterior	4
30 92 01 35	Esquadro alinhamento móvel	4
30 96 00 15	Esquadro alinhamento móvel exterior	4
30 96 00 45	Esquadro móvel interior	4
30 96 00 49	Esquadro alinhamento aro fixo	2
30 93 01 20	Junta exterior	2L
30 96 00 02	Junta interior	L+4H
---	Junta exterior vidro	2L+4H
---	Junta interior vidro	2L+4H

Vidro

Hv = H-228 mm	Lv = L/2-194 mm
---------------	-----------------

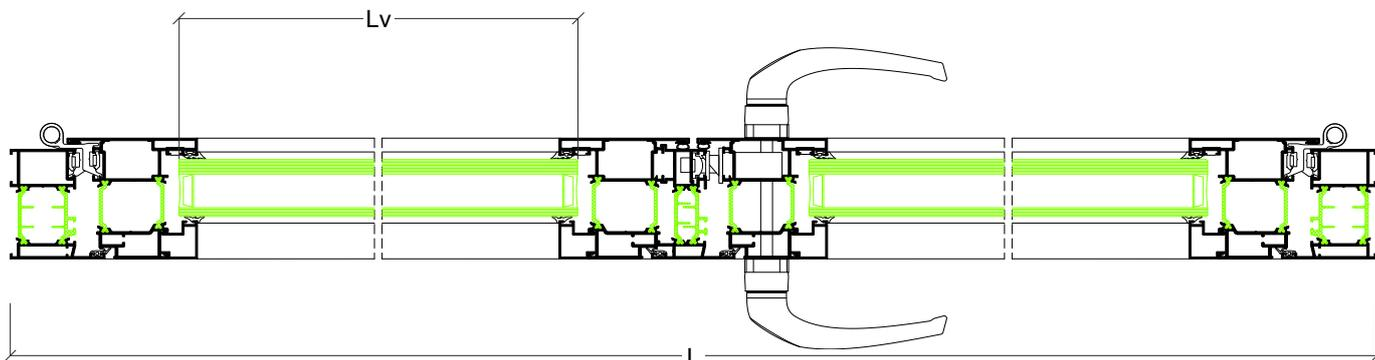

Porta oscilo-paralela com fixo lateral

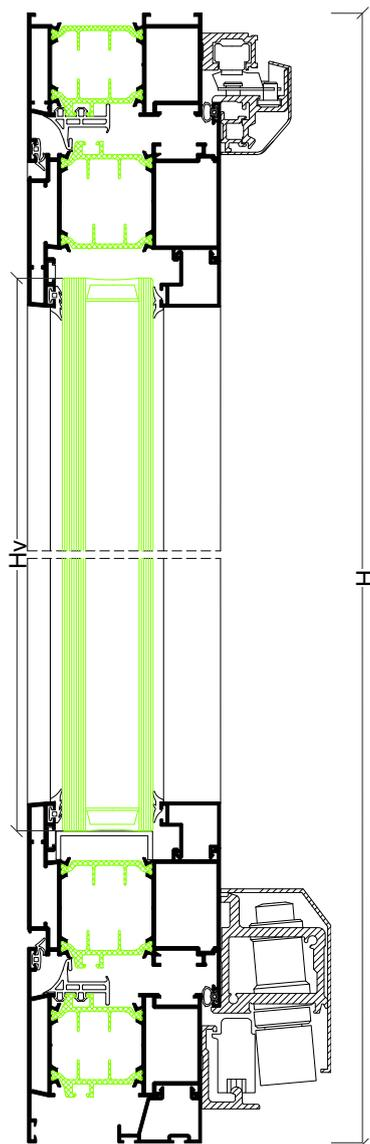
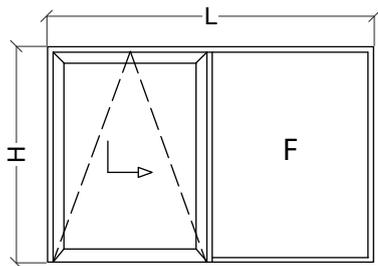

Perfis

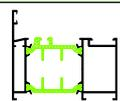
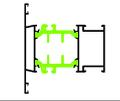
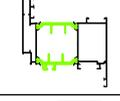
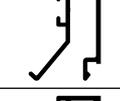
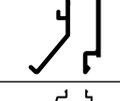
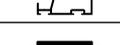
Desenho	Ref	Descrição	Corte	Quant	Medida
	AKi-08	Aro fixo		1	L
				2	H
	AKi-06	Travessa		1	L-80.5 mm
				1	H-100.5 mm
	AKi-36	Aro móvel		2	L1-55.5 mm
				4	H-98 mm
	---	Bite (folha)		2	L1-193 mm
				2	H-275.5 mm
	---	Bite (fixo)		2	L2-67.5 mm
				2	H-150 mm
	AX-15	Bite remate		1	L-90 mm
	AX-19	Vareta		1+1	Aprox. L+H

Acessórios e Juntas

Referência	Descrição	Quantidade
30 92 01 00	Goteiras	4
30 92 01 35	Esquadro alinhamento móvel	4
30 92 01 50	União topos porta	4
30 96 00 05	Esquadro aro fixo	2
30 96 00 15	Esquadro alinhamento móvel	4
30 96 00 36	Esquadro aro móvel	4
30 96 00 46	Esquadro alinhamento exterior aro móvel	4
30 96 00 49	Esquadro alinhamento aro fixo	2
---	Kit oscilo-paralela	1
30 96 10 01	Calço para vidro	4
30 96 00 02	Junta exterior	2L1+2H
30 96 10 04	Junta central	2L1+2H
30 93 01 20	Junta interior	2L1+2H
---	Junta exterior vidro	2L+2H
---	Junta interior vidro	2L+2H

Vidro

Hv folha = H-249 mm	Lv folha = L1-206 mm	
Hv fixo = H-124 mm	Lv fixo = L2-81 mm	
	Mínimo	Máximo
Largura da folha	700 mm	1650 mm
Altura da folha	850 mm	2400 mm
Peso máximo por folha 150 kg		

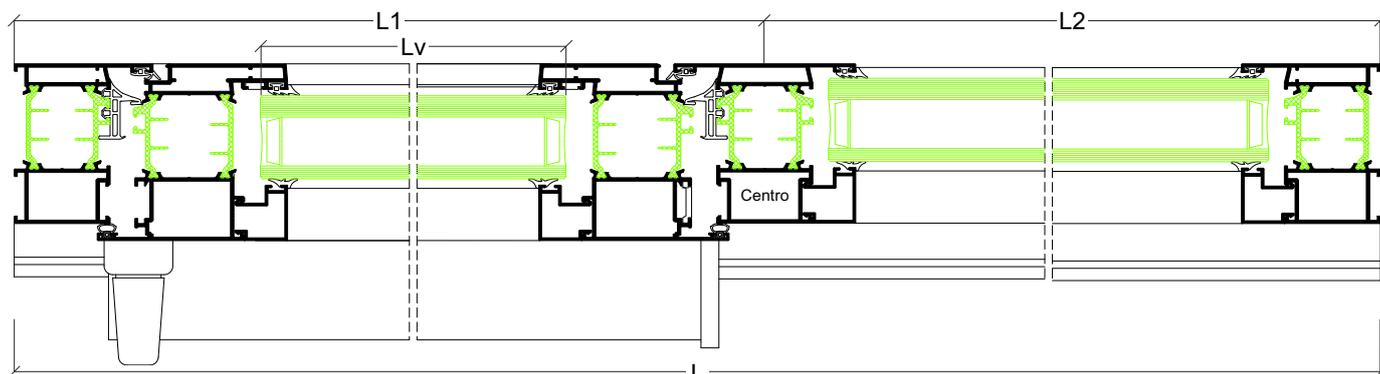

Porta 3 folhas harmónio

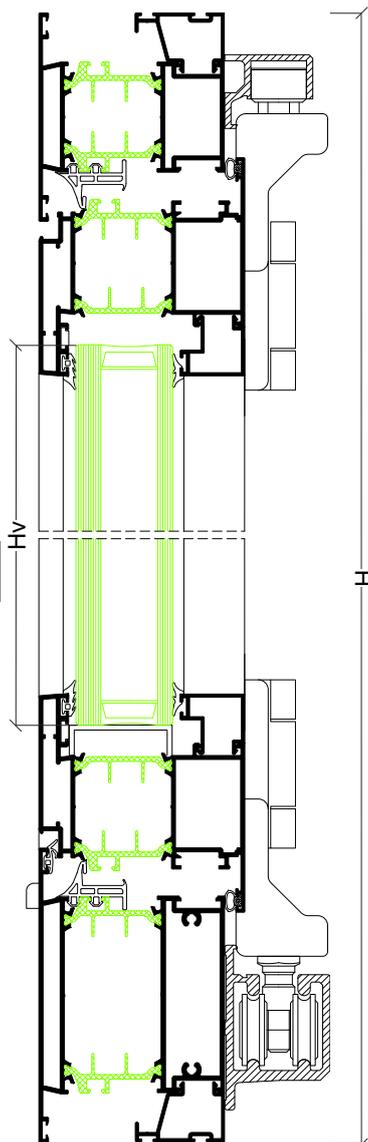
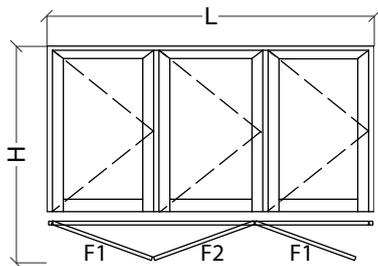

Perfis

Desenho	Ref	Descrição	Corte	Quant	Medida
	AKi-08	Aro fixo		2	H
	AKi-06	Travessa		1	L-80.5 mm
	AKi-12	Travessa		1	L-80.5 mm
	AKi-36	Aro móvel		6	consultar
				6	consultar
	AKi-04	Inversor		2	consultar
	---	Bite (folha)		6	consultar
				6	consultar
	AX-15	Bite remate		2	L-90 mm
	AX-19	Vareta		2	2H

Acessórios e Juntas

Referência	Descrição	Quantidade
30 92 01 00	Goteiras	6
30 92 01 35	Esquadro alinhamento móvel	12
30 96 10 08	Jogo topos inversor	2
30 96 00 15	Esquadro alinhamento aro móvel	12
30 96 00 36	Esquadro aro móvel porta	12
30 96 00 46	Esquadro alinhamento exterior porta	12
---	Kit harmónio (3+0)	1
30 92 01 50	União topo porta	2
30 92 01 20	Jogo fecho C.E.	1
30 96 10 01	Calço para vidro	12
30 96 00 02	Junta exterior	2L+6H
30 96 10 04	Junta central	2L+4H
30 93 01 20	Junta interior	2L+6H
---	Junta exterior vidro	2L+2H
---	Junta interior vidro	2L+2H

Vidro

Hv = consultar	Lv Folha 1 = consultar	
	Lv Folha 2 = consultar	
	Mínimo	Máximo
Largura da folha	600 mm	900 mm
Altura da folha	850 mm	2400 mm
Peso máximo por folha 80 kg		

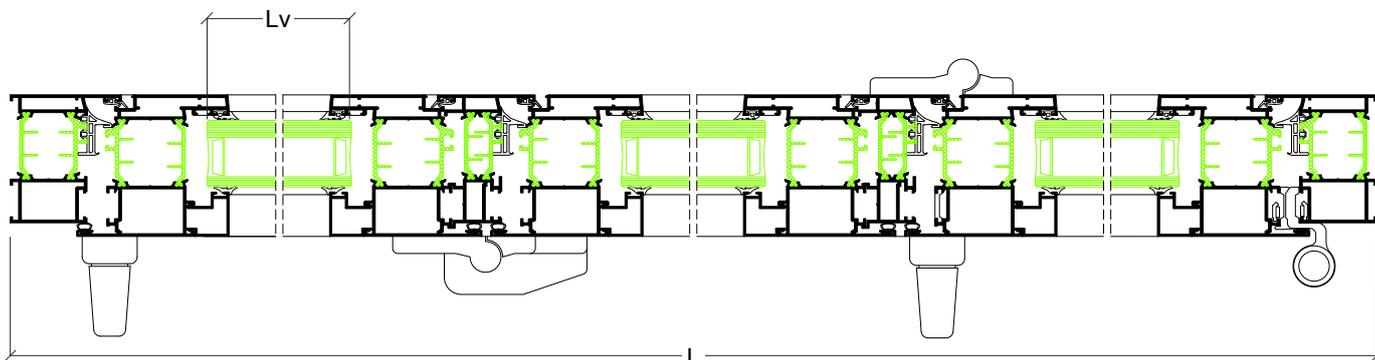

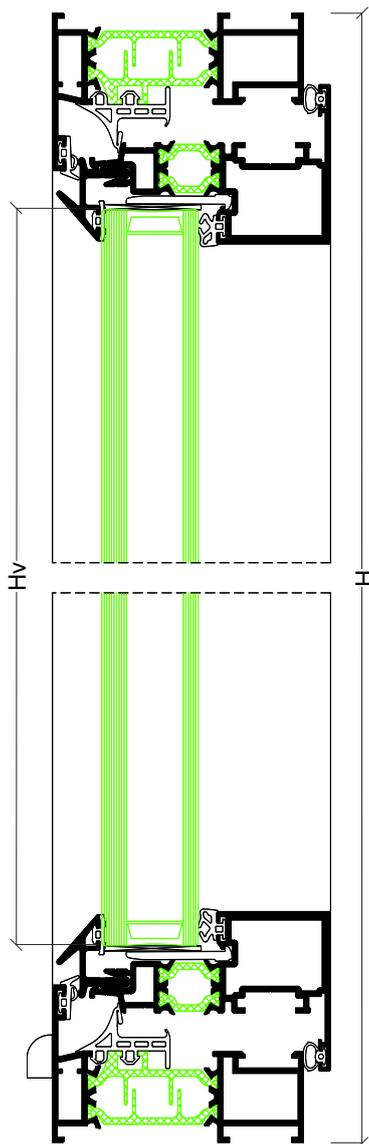
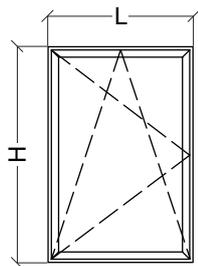
Janela 1 folha oscilo-batente (3D)

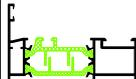
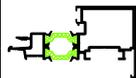
Perfis

Desenho	Ref	Descrição	Corte	Quant	Medida
	AKi-03	Aro fixo		2	L
				2	H
	AKi-78	Aro móvel		2	L-43 mm
				2	H-43 mm
	AKi-52	Bite		2	L-87 mm
				2	H-87 mm
	AX-19	Vareta		várias	---

* Preferencialmente cortar juntamente com o perfil AKi-78

Acessórios e Juntas

Referência	Descrição	Quantidade
30 96 00 04	Esquadro interior aro fixo	4
30 96 00 39 ou 48	Esquadro exterior aro fixo	4
30 96 10 15	Esquadro interior aro móvel	4
30 96 00 44	Esquadro exterior aro móvel	4
30 96 00 55	Pino para esquadro	8
30 92 01 35	Esquadro de alinhamento	4
30 92 01 02	Goteira com válvula (cor preto)	2 ou mais
30 96 10 05	Junta vedação AKi - folha oculta 3D	2L+2H
30 96 00 02	Junta exterior	L+2H
30 96 10 04	Junta central	2L+2H
30 93 01 20	Junta interior	2L+2H
---	Junta interior vidro	2L+2H
---	Ferragem oscilo-batente	---

121

Vidro

Hv = H-115 mm	Lv = L-115 mm
---------------	---------------

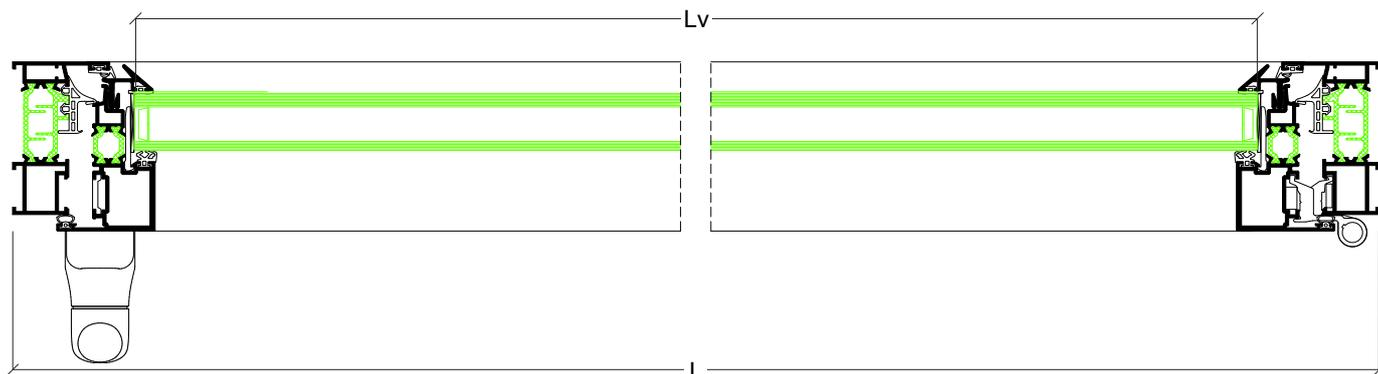

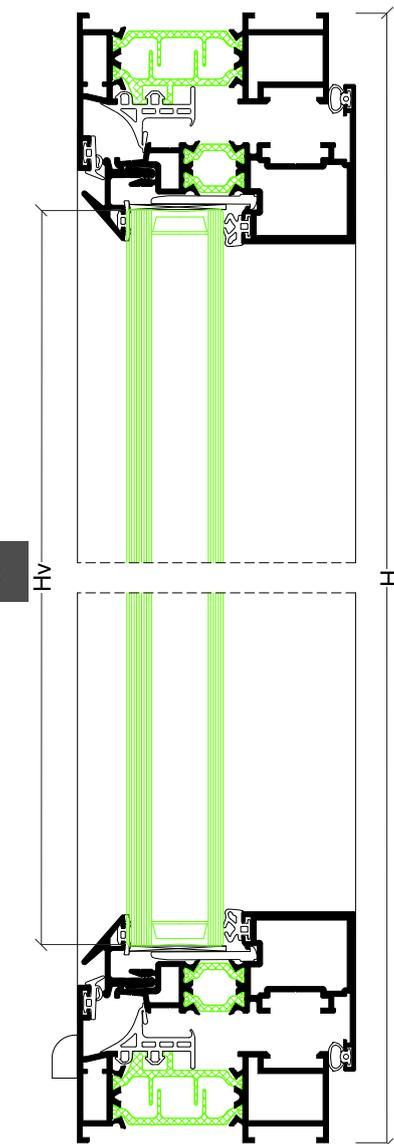
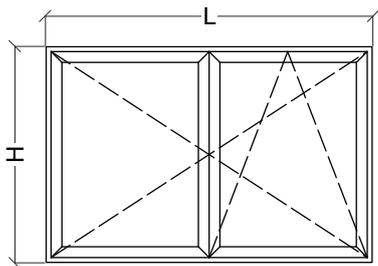
Janela 2 folhas oscilo-batente (3D)

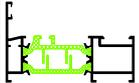
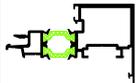
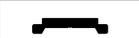
Perfis

Desenho	Ref	Descrição	Corte	Quant	Medida
	AKi-03	Aro fixo		2	L
				2	H
	AKi-78	Aro móvel		4	(L/2)-24 mm
				4	H-43 mm
	AKi-52	Bite		4	(L/2)-68 mm
				4	H-87 mm
	AKi-04	Inversor		1	H-119 mm
	AX-19	Vareta		várias	---

* Preferencialmente cortar juntamente com o perfil AKi-78

Acessórios e Juntas

Referência	Descrição	Quantidade
30 96 00 04	Esquadro interior aro fixo	4
30 96 00 39 ou 48	Esquadro exterior aro fixo	4
30 96 10 15	Esquadro interior aro móvel	8
30 96 00 44	Esquadro exterior aro móvel	8
30 96 00 55	Pino para esquadro 30 96 00 44	16
30 92 01 35	Esquadro de alinhamento	8
30 92 01 02	Goteira com válvula (cor preto)	2 ou mais
30 92 01 14	Conjunto topo inversor	1
30 92 02 60	Calço de apoio da folha passiva	1
30 96 10 05	Junta vedação AKi - folha oculta 3D	2L+4H
30 96 00 02	Junta exterior	L+4H
30 96 10 04	Junta central	2L+3H
30 93 01 20	Junta interior	2L+4H
---	Junta interior vidro	2L+4H
---	Ferragem oscilo-batente	---

Vidro

Hv = H-115 mm	Lv = (L/2)-96 mm
---------------	------------------

