



Sistema

ARi

Sistema ARi

Sistema de batente com RPT - 60 mm

Características do sistema

Sistema de batente com rotura térmica e de elevadas prestações térmicas e acústicas.

O sistema ARi possibilita a execução de 5 versões de caixilharia:

1. linha recta;
2. linha curva;
3. linha tradição;
4. linha oval;
5. Folha Oculta.

O sistema ARi permite a aplicação de vidros duplos ou triplos de alto rendimento de modo a responder às exigências de isolamento térmico e acústico.

A versão ARi Folha Oculta permite a ocultação do aro móvel.

Perfis de alumínio

Os perfis de alumínio são extrudidos na liga de alumínio 6060 para arquitectura de acordo com norma NP EN 12020-02.

Rotura térmica obtida por inserção de varetas isolantes de poliamida tipo ómega de 24 mm, reforçadas com 25% de fibra de vidro.

Espessura média dos perfis de alumínio de 1.5 mm para janelas e de 1.7 mm para portas.

Aros fixos

Secção dos aros fixos de 60 mm ou 84.5 mm com tripla câmara;

Aros fixos com esquadros duplos para montagem a meia esquadria;

Aros fixos tradicionais para mercado interno;

Aros fixos com clip exterior e aba de remate direta de 25 mm ou 45 mm;

Aros fixos com clip exterior e interior para aplicação de remate de 30 mm.

Aros móveis

Secção dos aros móveis de 68 mm com tripla câmara;

Enchimento para vidro duplo ou triplo de 10 mm a 45 mm para o sistema ARi;

Enchimento para vidro duplo até 23 mm para o sistema ARi Folha Oculta;

Aros móveis de linha recta, curva, tradição ou oval (sem bite);

Aros móveis com esquadros duplos para montagem a meia esquadria;

Perfil inversor de linha recta.

Dimensionamento e manobralidade

Dimensões mínimas - máximas de folha: 400 mm - 1500 mm (L); 400 mm - 2700 mm (H);

Possibilidades de abertura: fixo, batente interior 1 ou 2 folhas com oscilo-batente, exterior, basculante, projectante, pivotante, harmónio e oscilo-paralela;

Estanquidade assegurada através de juntas triplas em EPDM.

Performances

Sistema certificado por laboratório notificado para Ensaio Tipo Inicial (ITT) de acordo com a norma de produto EN 14351-1 para efeitos de Marcação CE.

Categorias alcançadas na avaliação do sistema ARi tipologia janela:

1. Permeabilidade ao ar: Classe 4 (norma de ensaio EN 1026)
2. Estanquidade à água: Classe E750 (norma de ensaio EN 1027)
3. Resistência ao vento: Classe C5 (norma de ensaio EN 12211)

Categorias alcançadas na avaliação do sistema ARi tipologia porta:

1. Permeabilidade ao ar: Classe 4 (norma de ensaio EN 1026)
2. Estanquidade à água: Classe 9A (norma de ensaio EN 1027)
3. Resistência ao vento: Classe C3 (norma de ensaio EN 12211)
4. Resistência à torção estática: Apto 350N (norma de ensaio EN 14609)

Categorias alcançadas na avaliação do sistema ARi-Folha Oculta tipologia janela:

1. Permeabilidade ao ar: Classe 3 (norma de ensaio EN 1026)
2. Estanquidade à água: Classe 7A (norma de ensaio EN 1027)
3. Resistência ao vento: Classe C5 (norma de ensaio EN 12211)

Coefficiente de transmissão térmica de vão de 2 folhas, sistema Ari, com 1.20 m x 1.50 m com vidro $U_g = 0.7 \text{ W/m}^2\text{K}$, com intercalar efeito "Warm Edge":

• $U_w = 1.54 \text{ W/m}^2\text{K}$

Coefficiente de transmissão térmica de vão de 2 folhas, sistema ARi Folha Oculta com 1.80 m x 2.20 m com vidro $U_g = 1.1 \text{ W/m}^2\text{K}$, com intercalar efeito "Warm Edge":

• $U_w = 1.70 \text{ W/m}^2\text{K}$

Coefficiente de atenuação acústica de vão de 2 folhas com vidro 4/16 (gás Argon)/6:

• $R_w (C; C_{tr}) = 34 \text{ dB} (-1; -4)$

Zonas de aplicação segundo RCCTE (em função do valor U_g): I1, I2, I3, V1, V2, V3.

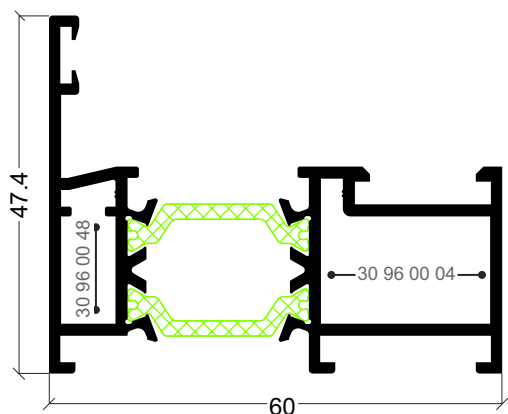

ARi-03
Aro fixo

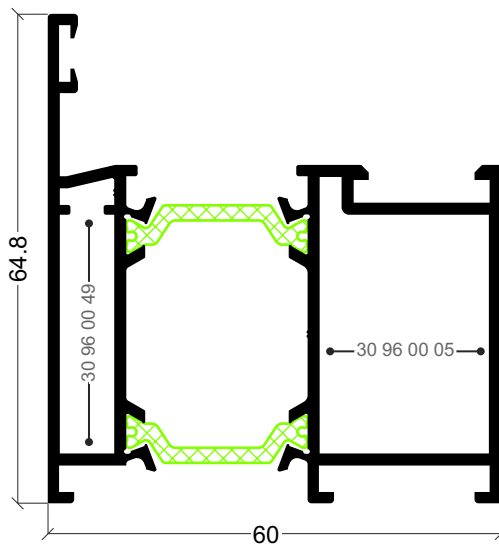

ARi-08
Aro fixo

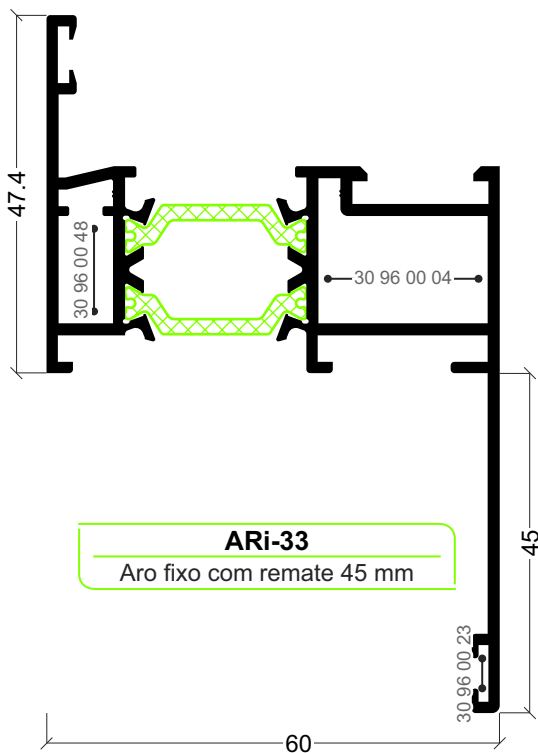

ARi-33
Aro fixo com remate 45 mm

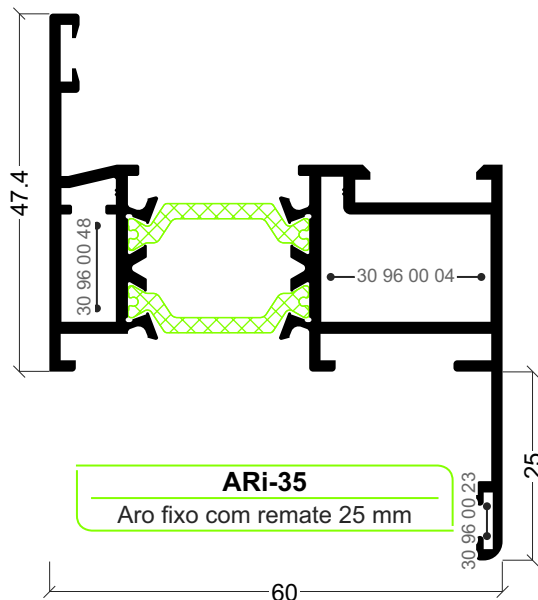

ARi-35
Aro fixo com remate 25 mm

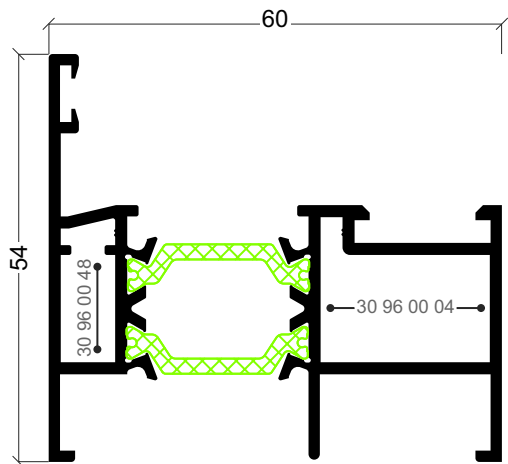

ARi-81
Aro fixo

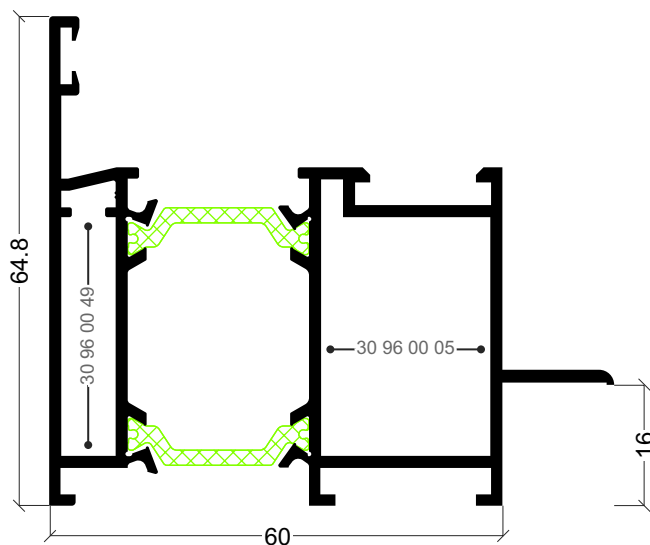

ARi-68
Aro fixo para apanelado

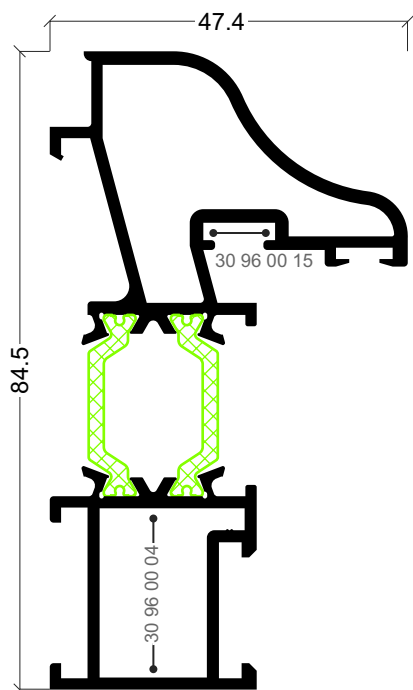

ARi-57
Aro fixo tradição

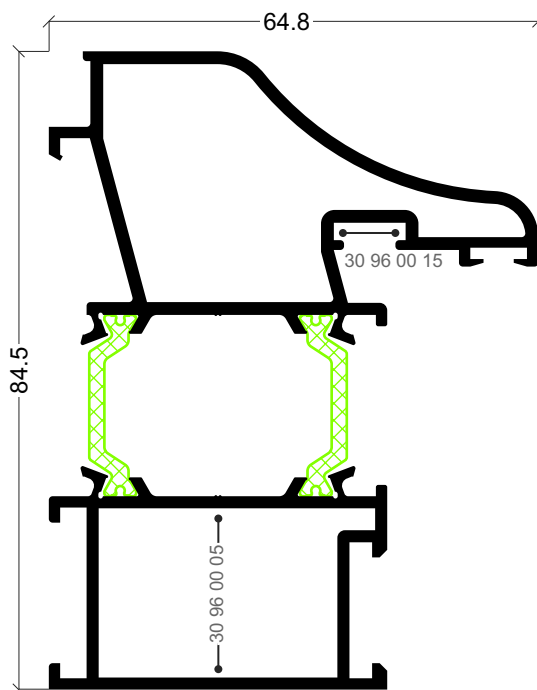

ARi-59
Aro fixo tradição

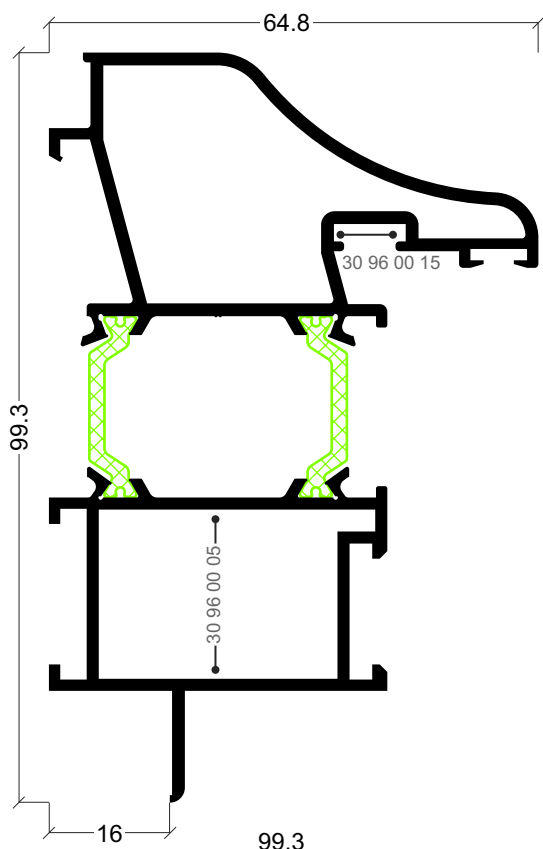

ARi-69
Aro fixo para apainelado

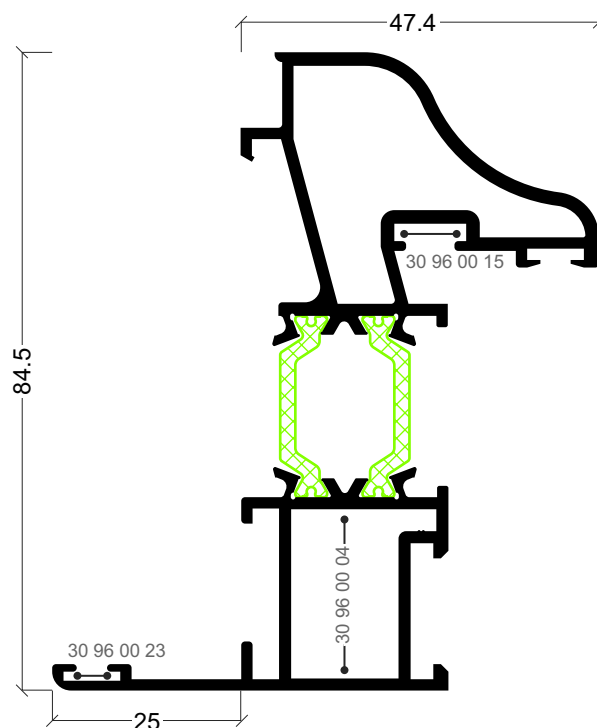

ARi-77
Aro fixo com remate

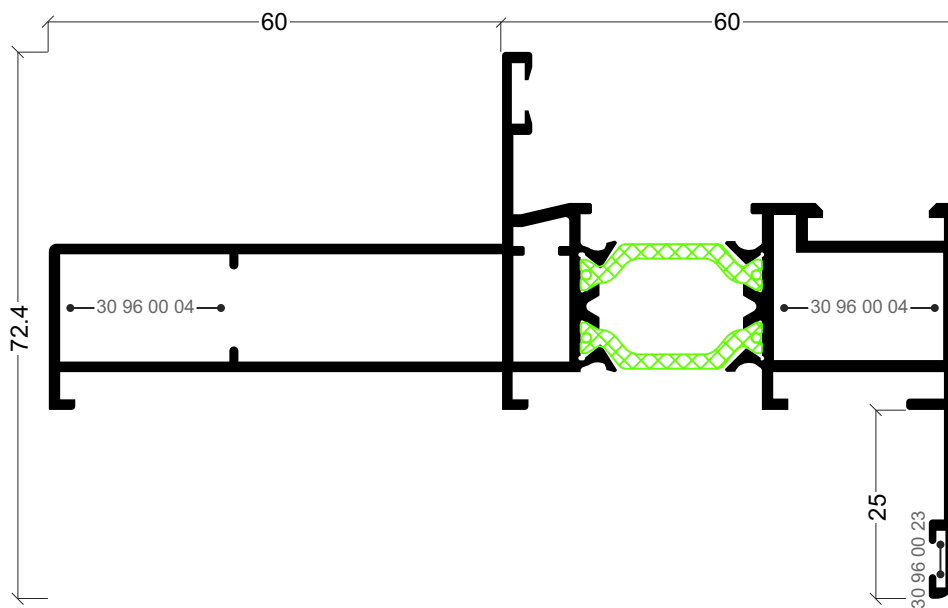

ARi-86
Aro fixo com remate

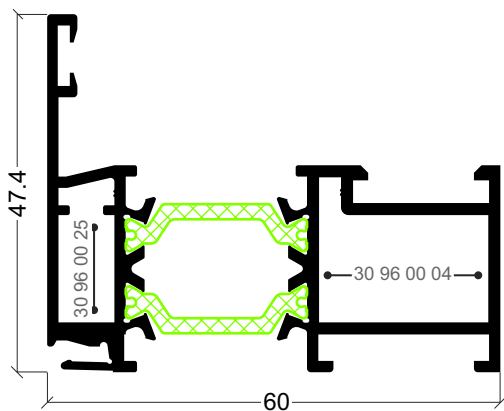

ARi-76
Aro fixo

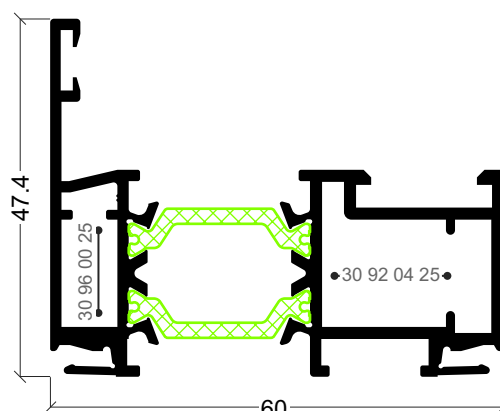

ARi-80
Aro fixo com clip interior/exterior

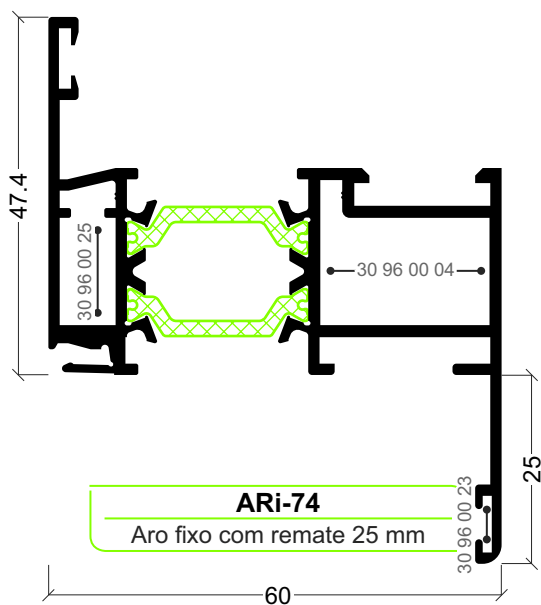

ARi-74
Aro fixo com remate 25 mm

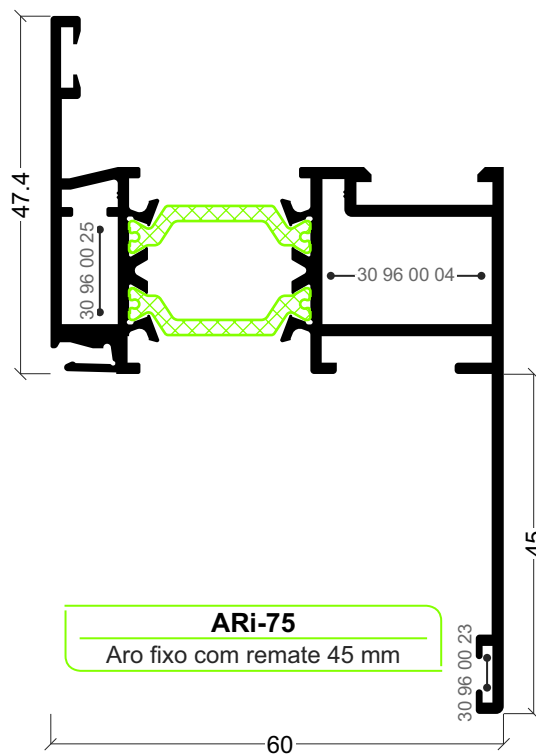

ARi-75
Aro fixo com remate 45 mm

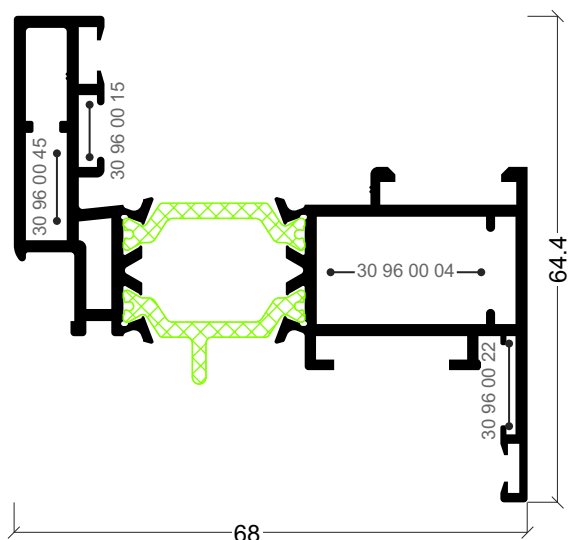

ARi-61
Aro móvel

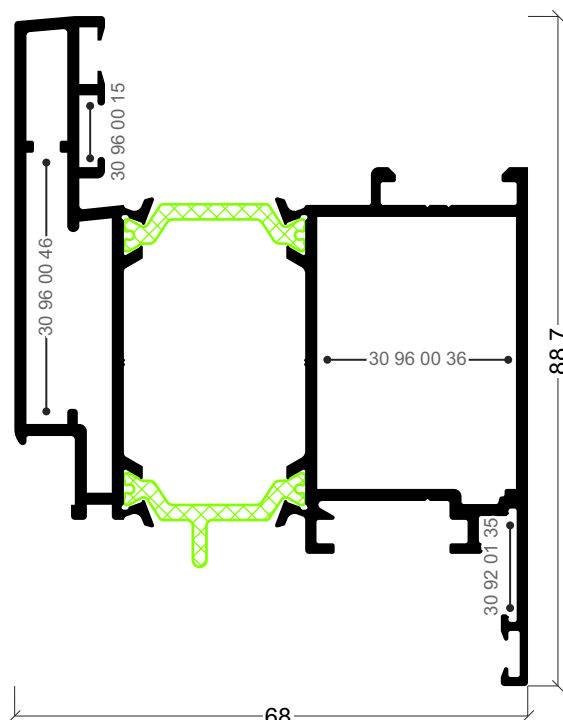

ARi-36
Aro móvel

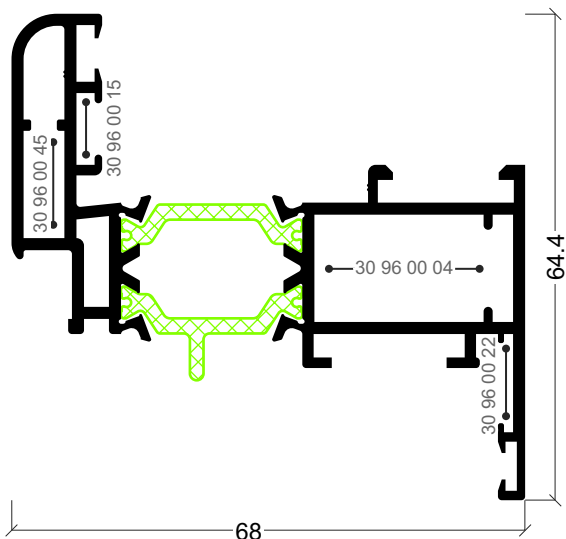

ARi-05
Aro móvel

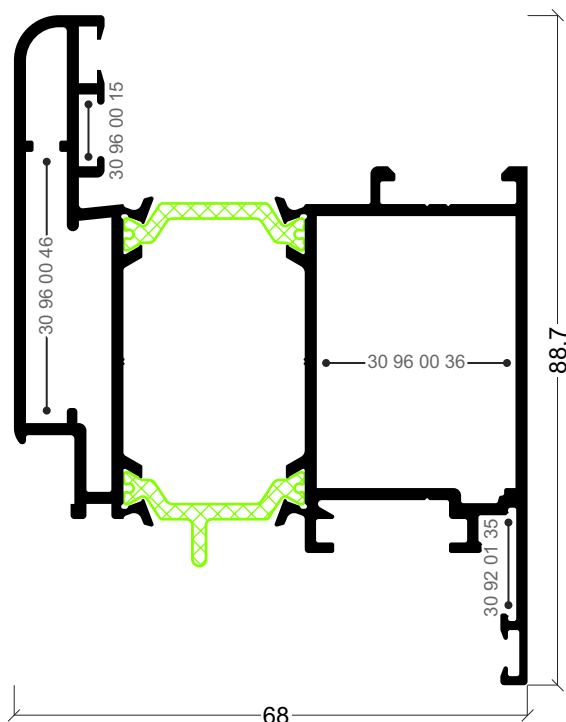

ARi-10
Aro móvel

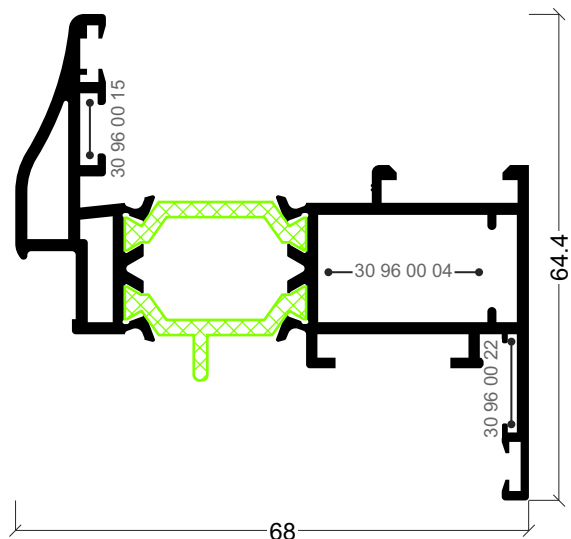

ARi-58
Aro móvel tradição

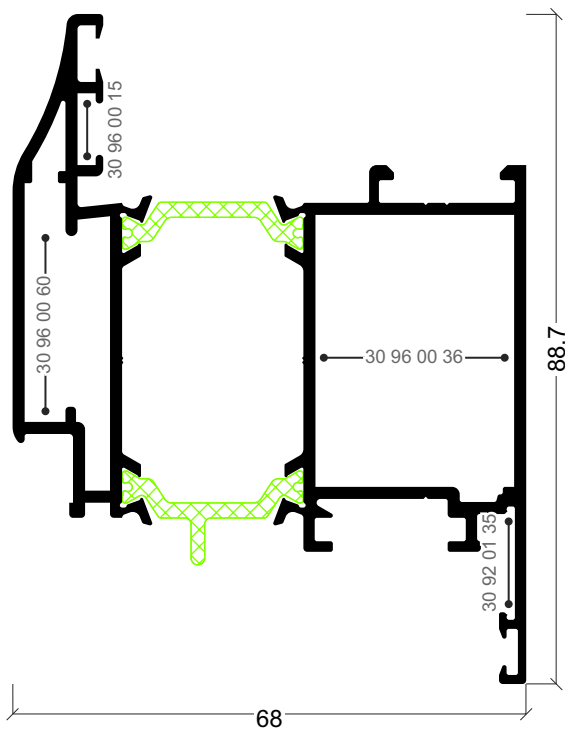

ARi-60
Aro móvel tradição

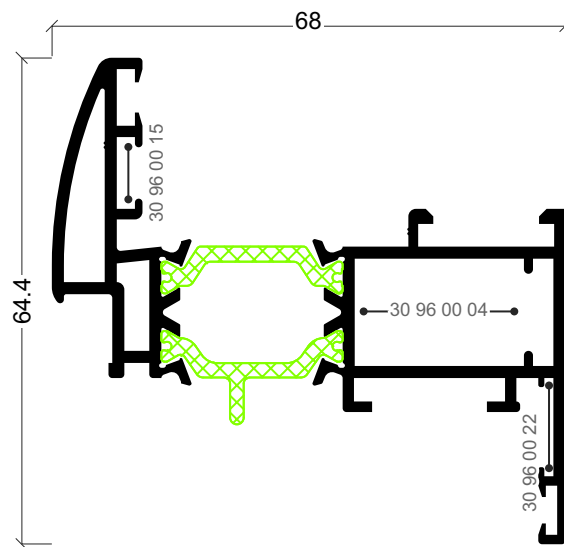

ARi-83
Aro móvel

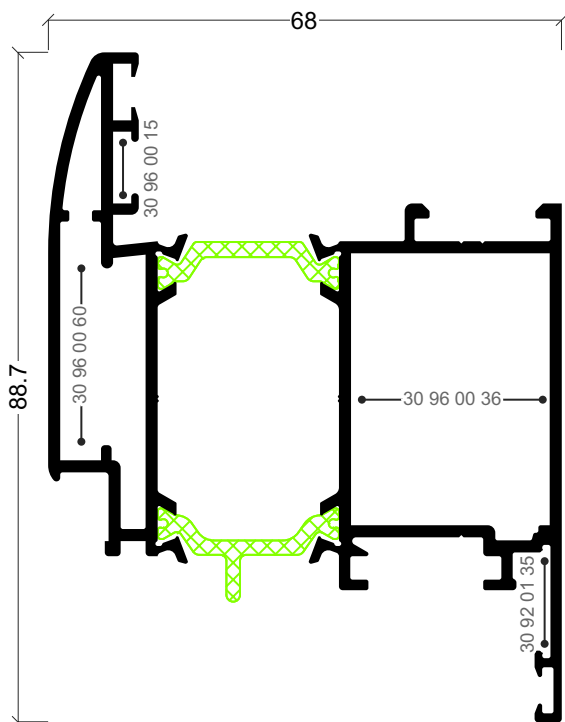

ARi-84
Aro móvel

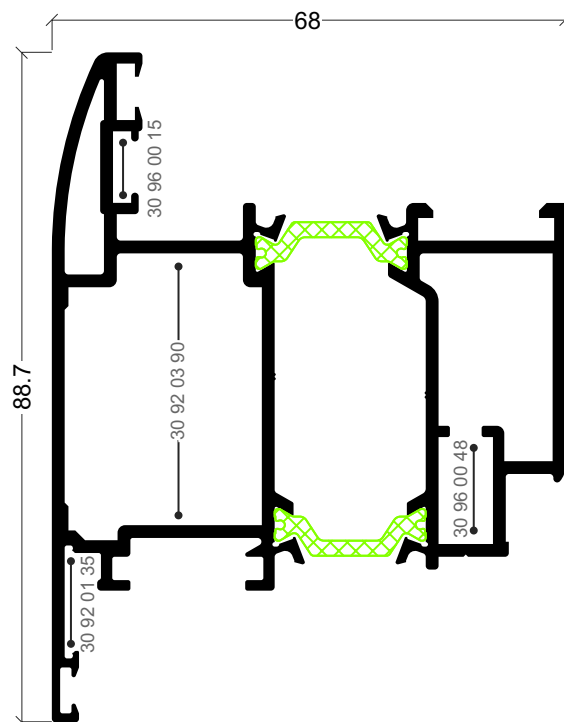

ARi-85
Aro móvel

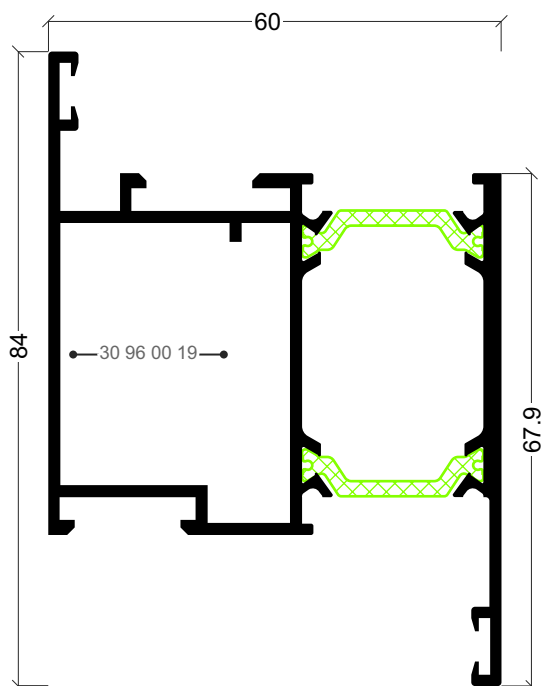

ARI-11
Aro fixo abertura exterior com fixo lateral

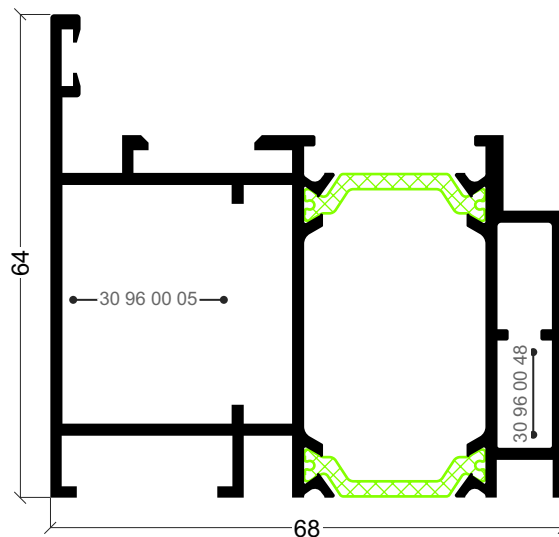

ARI-09
Aro fixo abertura exterior ARI-25

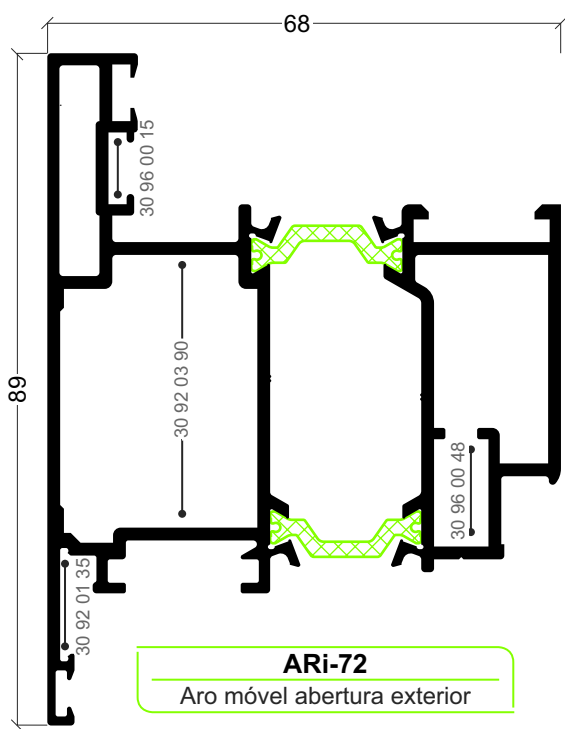

ARI-72
Aro móvel abertura exterior

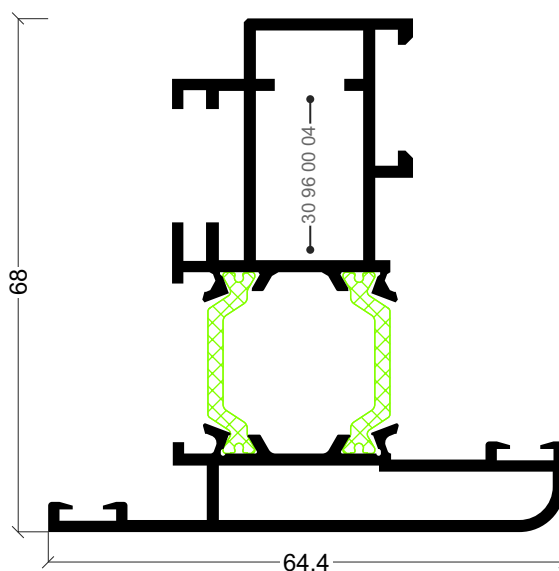

ARI-02
Aro móvel pivotante

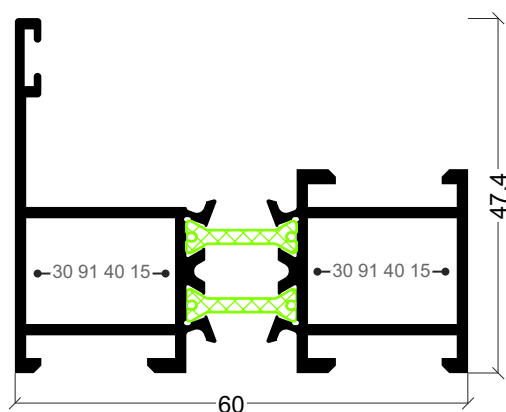

ARI-38
Aro fixo projectante

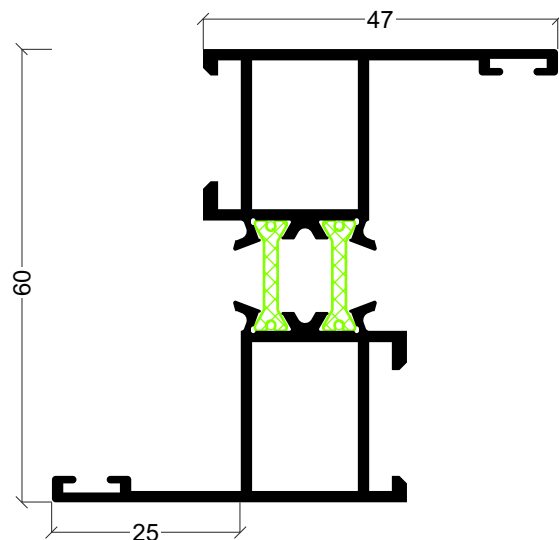

ARI-39
Aro fixo projectante com fixo

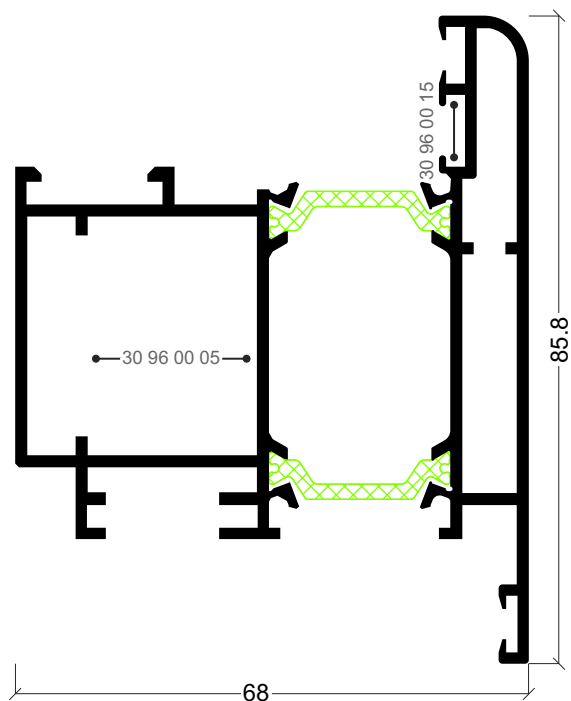

ARi-25
Aro móvel abertura exterior ou pivotante

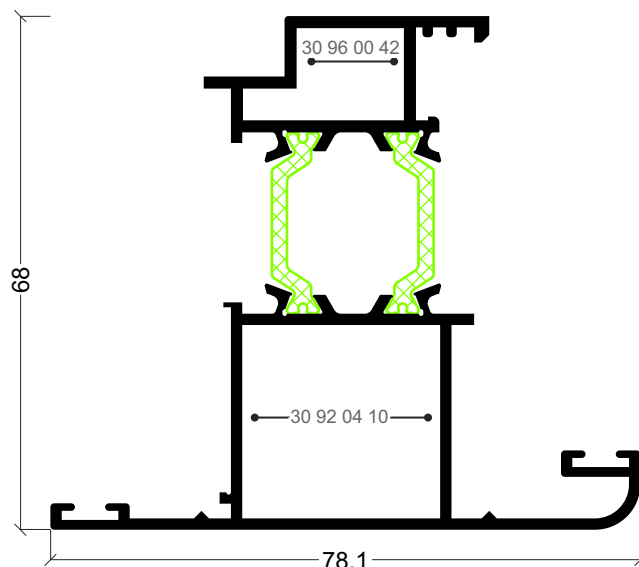

ARi-07
Aro móvel projectante

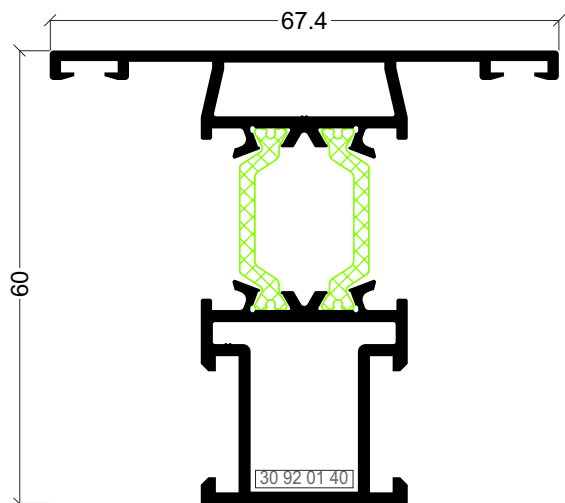

ARi-01
Travessa

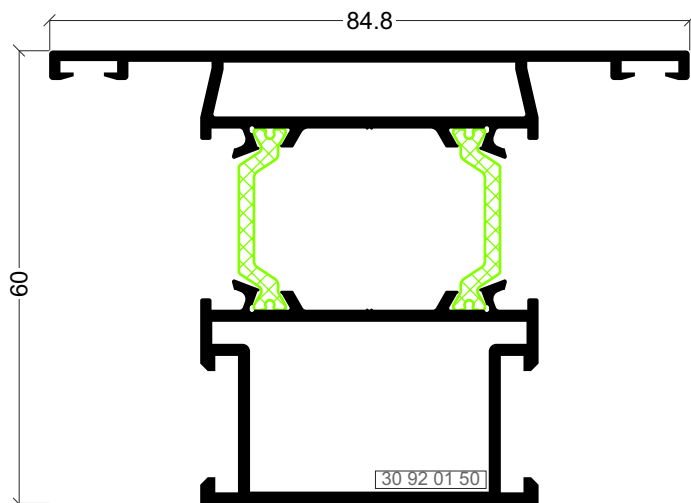

ARi-06
Travessa

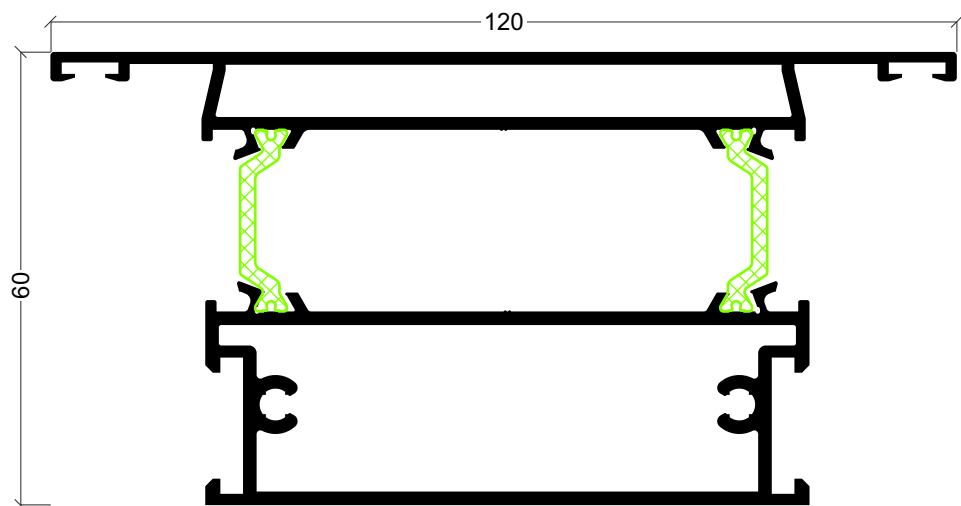

ARi-12
Travessa

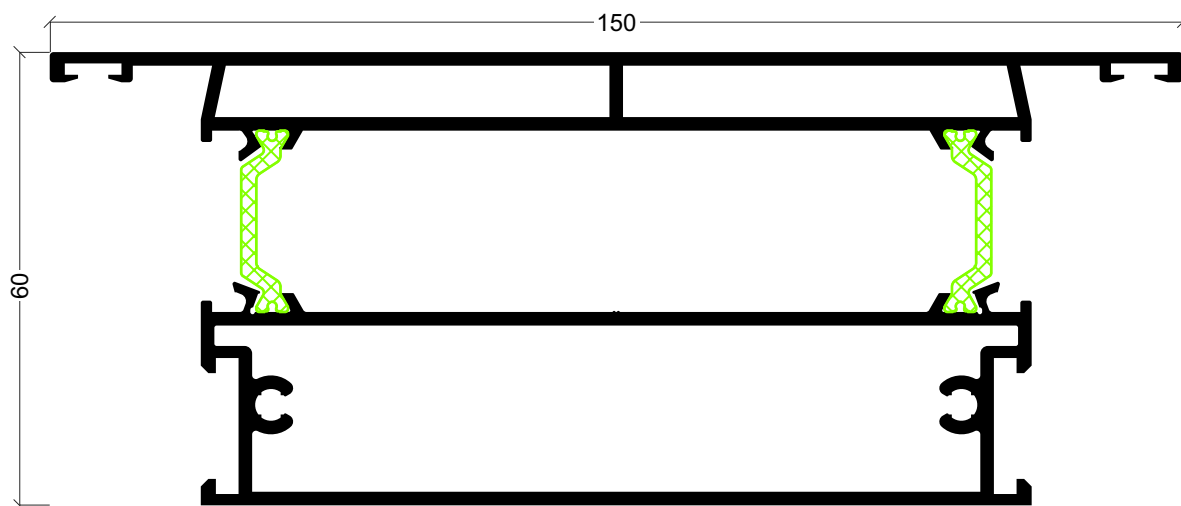

ARi-13
Traversa

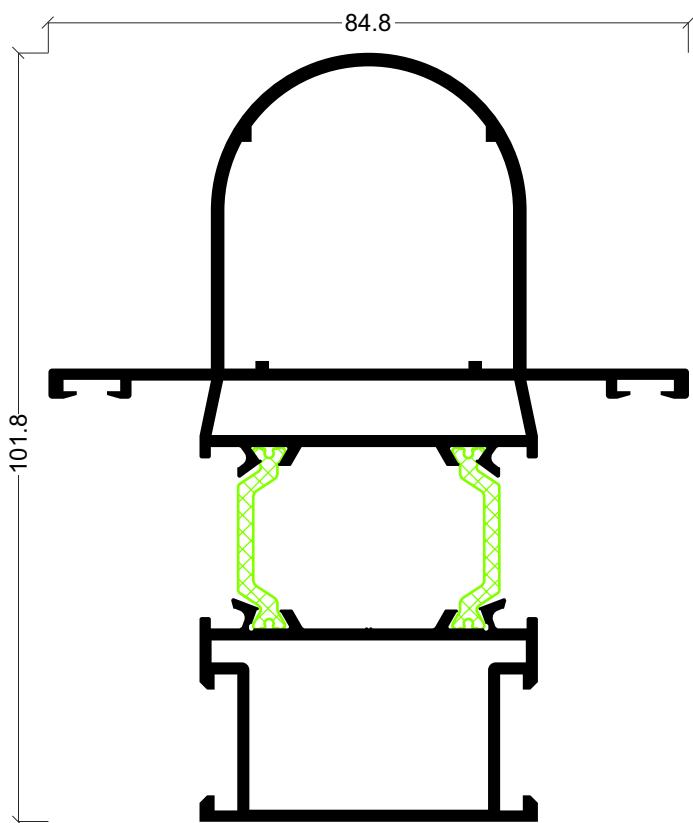

ARi-17
Montante Curvo

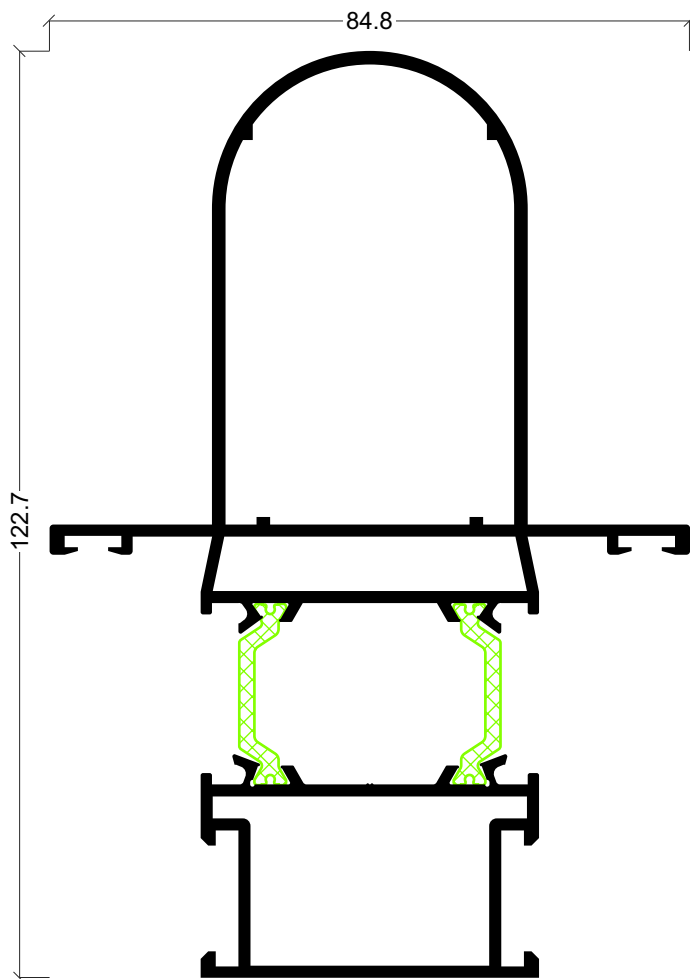

ARi-18
Montante Curvo

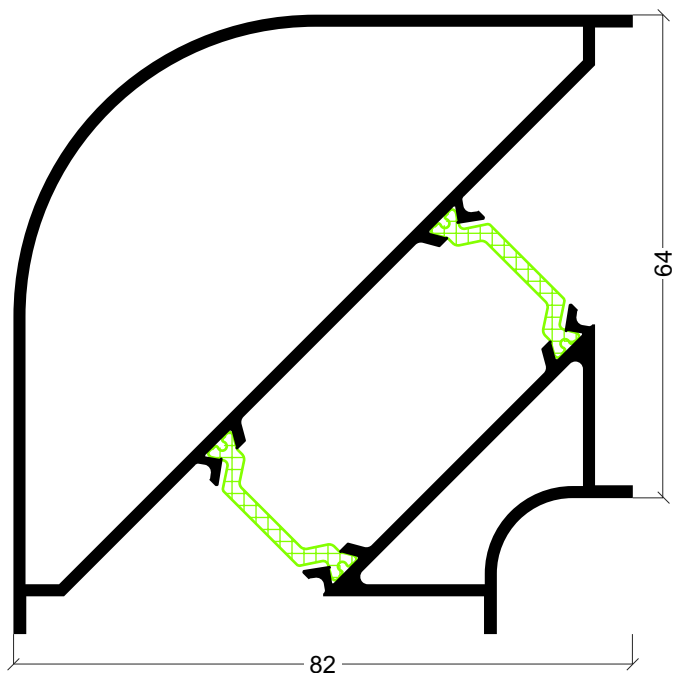

ARi-16
Esquina 90°

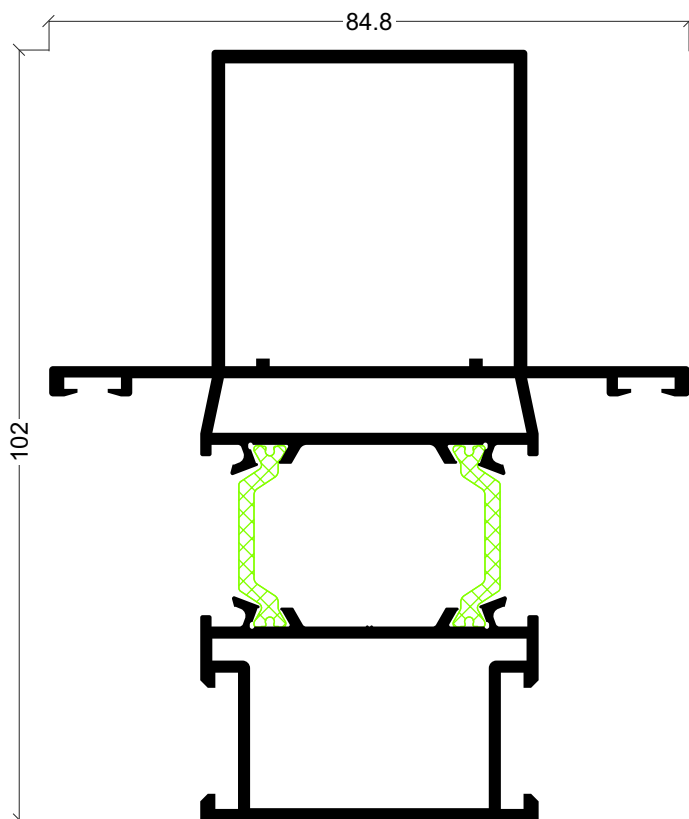

ARi-79
Montante recto

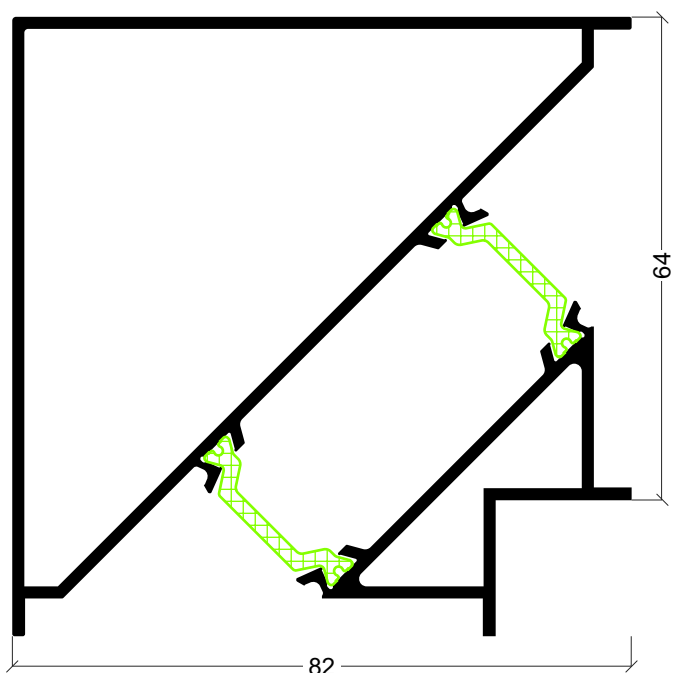

ARi-64
Esquina 90°

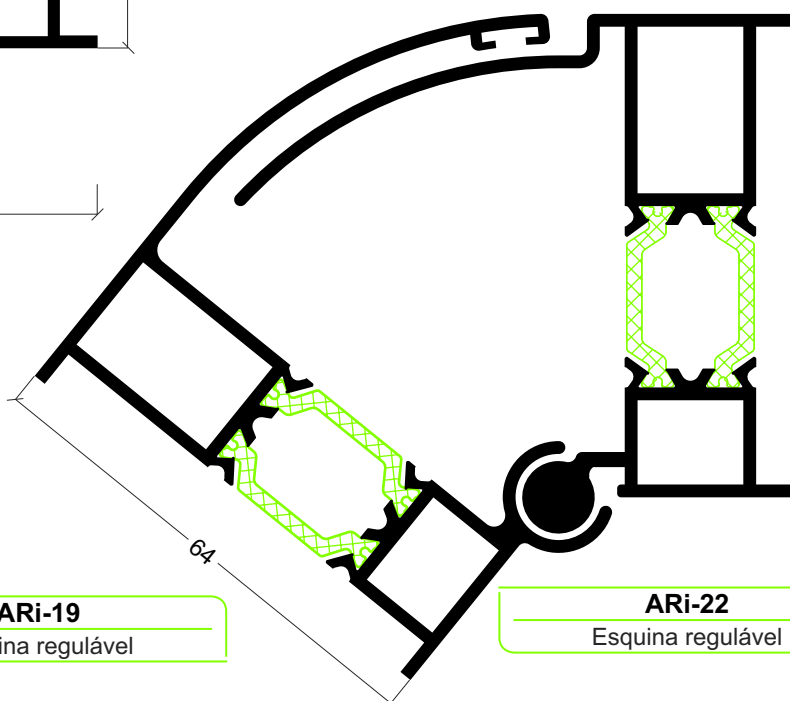

ARi-19
Esquina regulável

ARi-22
Esquina regulável

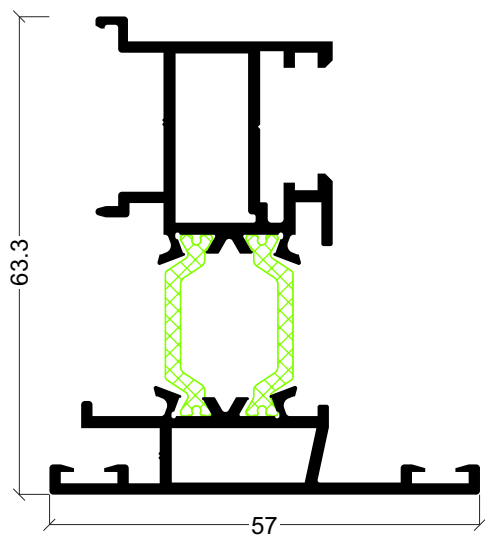

ARI-04
Inversor

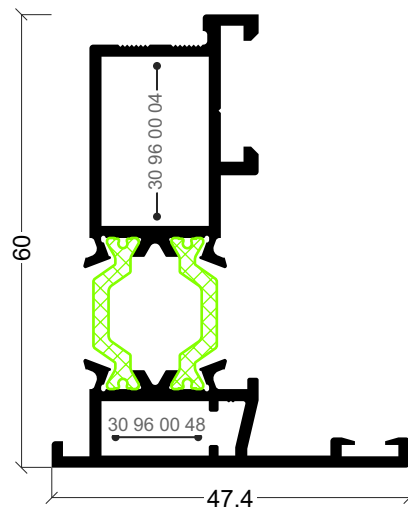

ARI-73
Inversor de sentido de abertura

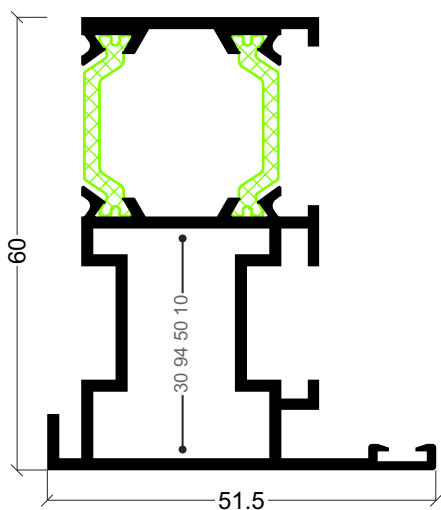

ARI-14
Inversor pivotante

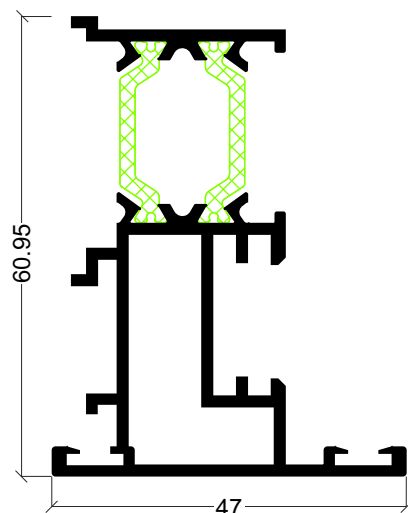

ARI-15
Inversor para ARI-25

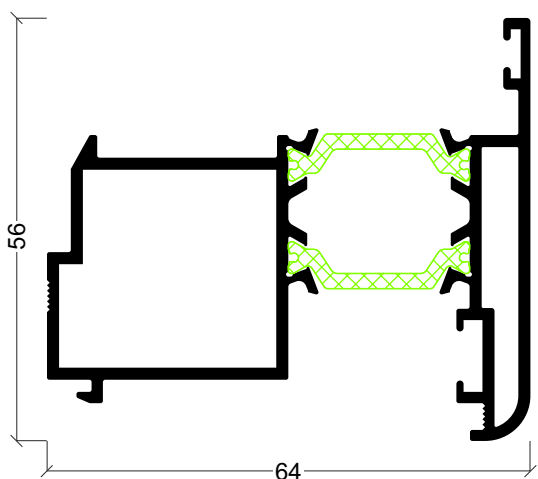

ARI-51
Inversor projectante

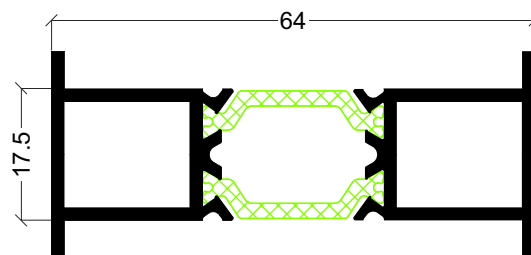

ARI-21
União de aros

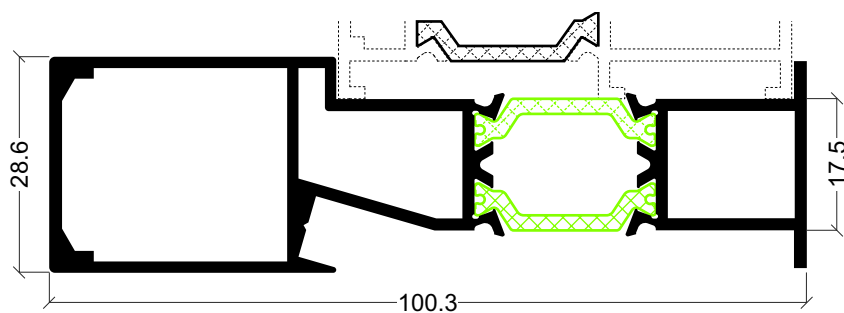

ARi-65
União de aros com reforço

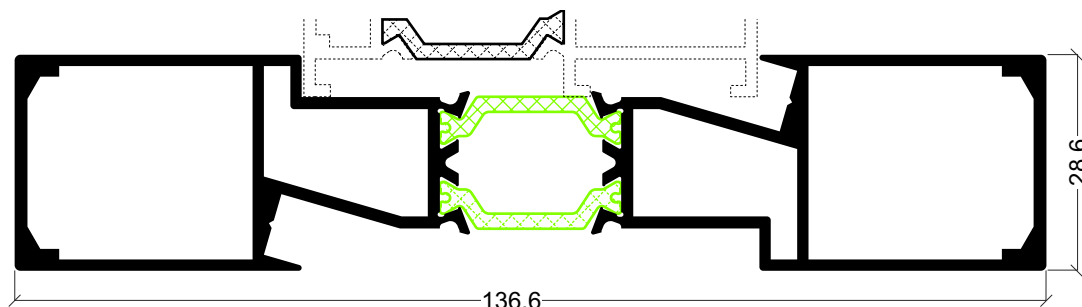

ARi-67
União de aros com reforço

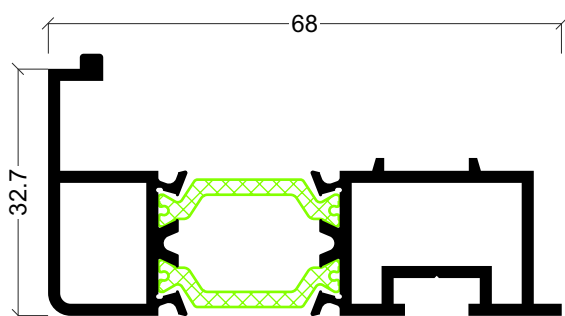

ARi-23
Remate almofada

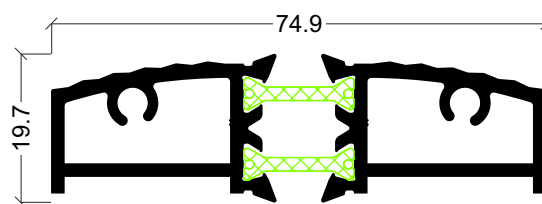

AXi-69
Remate inferior porta

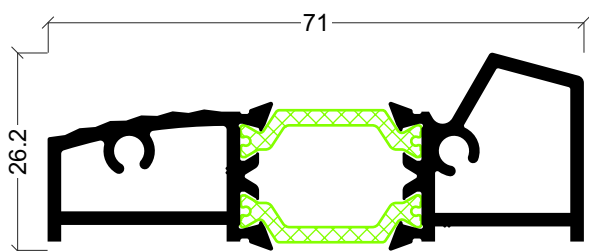

ARi-63
Remate inferior porta

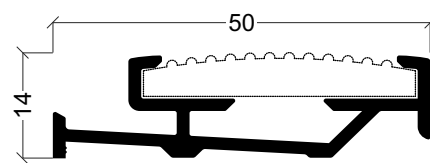

AZ-69
Remate inferior porta

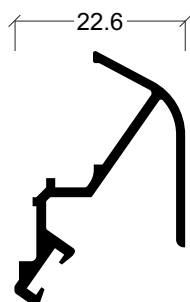

ARi-62
Pingadeira inferior porta

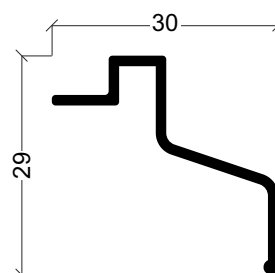

AXi-45
Pingadeira

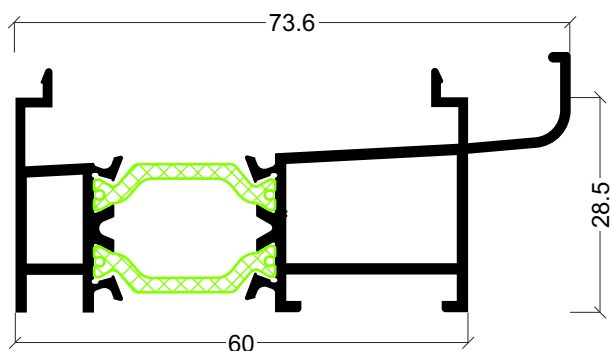

CT-11
Soleira condensação

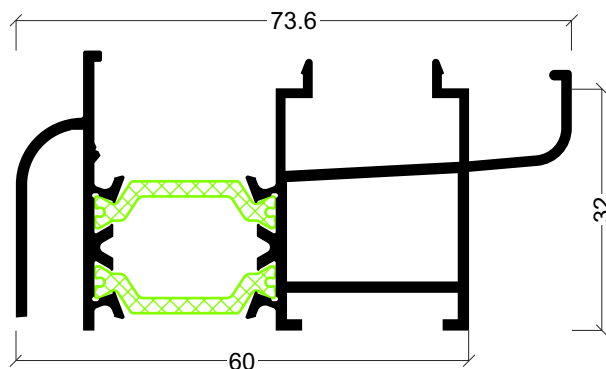

ARi-49
Soleira condensação

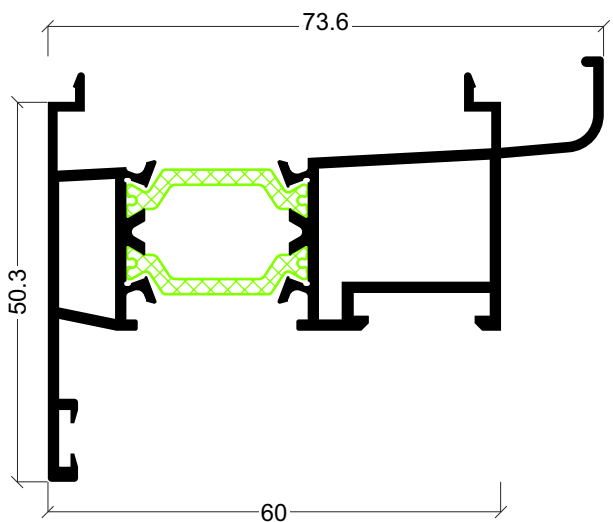

ARi-20
Soleira condensação com fixo inferior

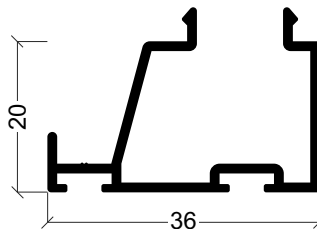

AX-15
Bite remate

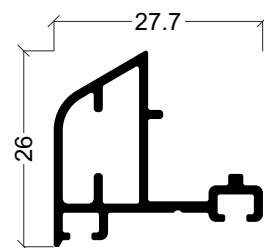

AZ-79
Pingadeira

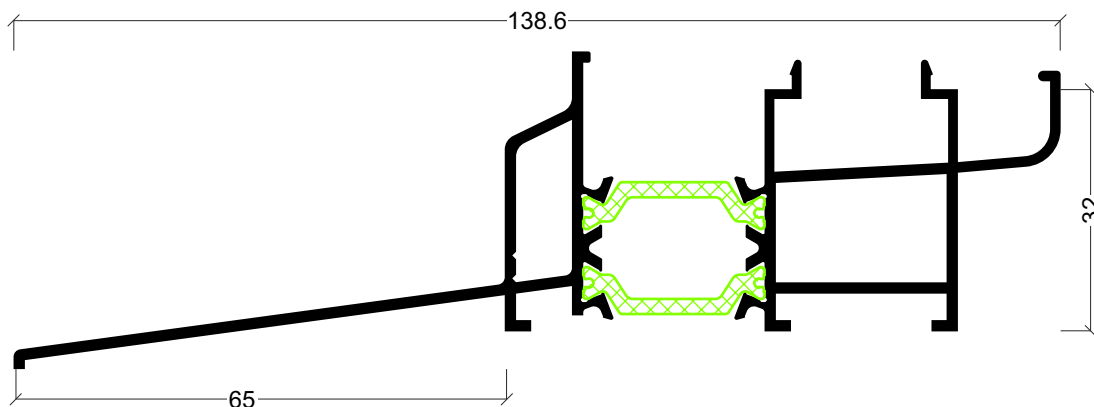

ARi-50
Soleira condensação com pingadeira

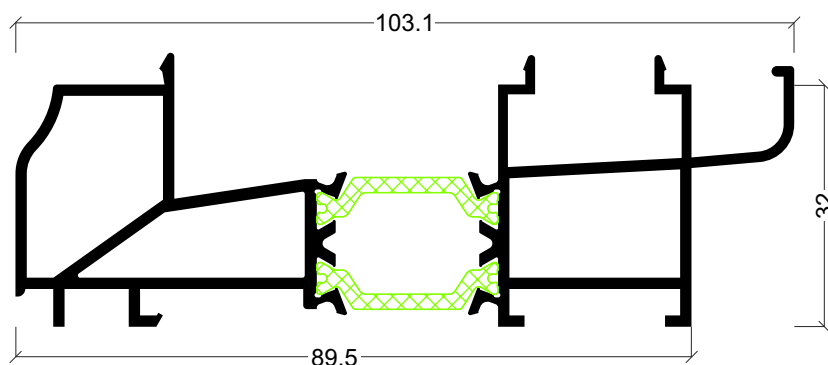

ARi-56
Soleira condensação tradição

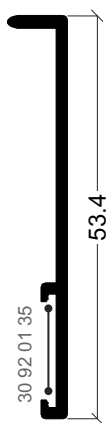

AXi-91
Complemento remate

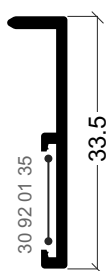

AXi-88
Complemento remate

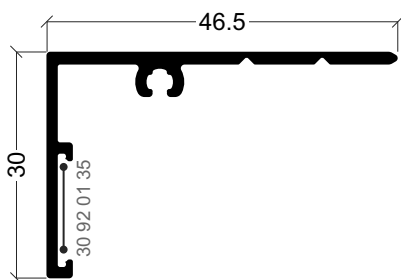

AXi-80
Remate

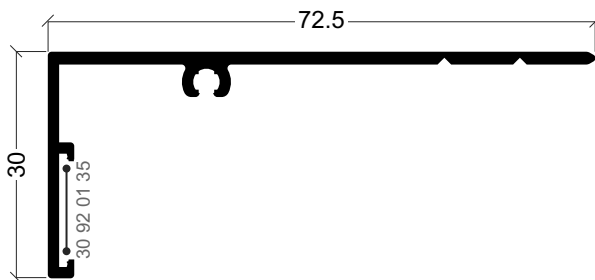

AXi-83
Remate

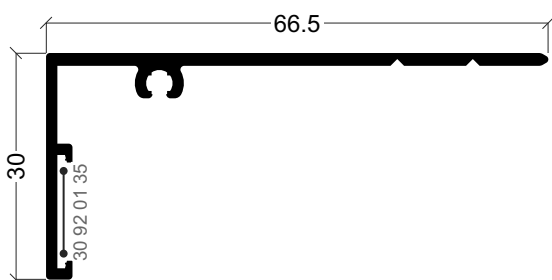

AXi-73
Remate

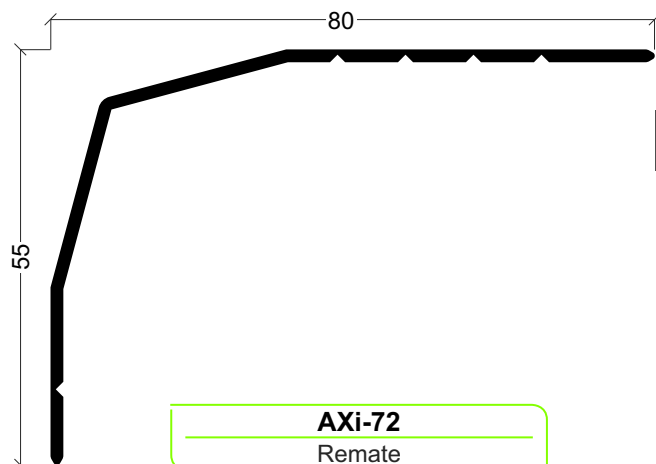

AXi-72
Remate

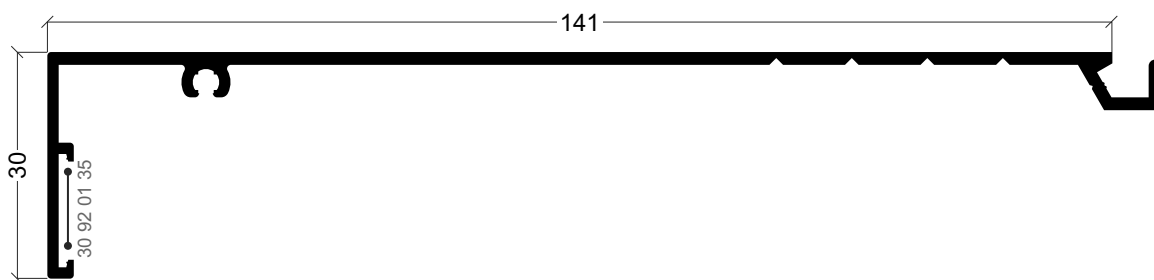

S-09
Remate

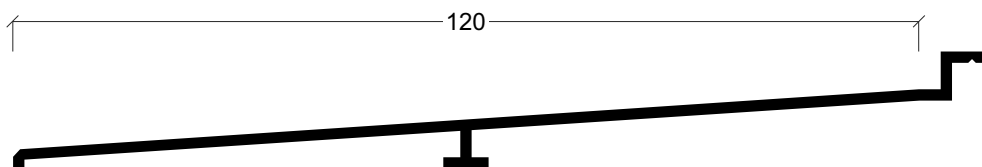

AZ-24
Pingadeira 120 mm

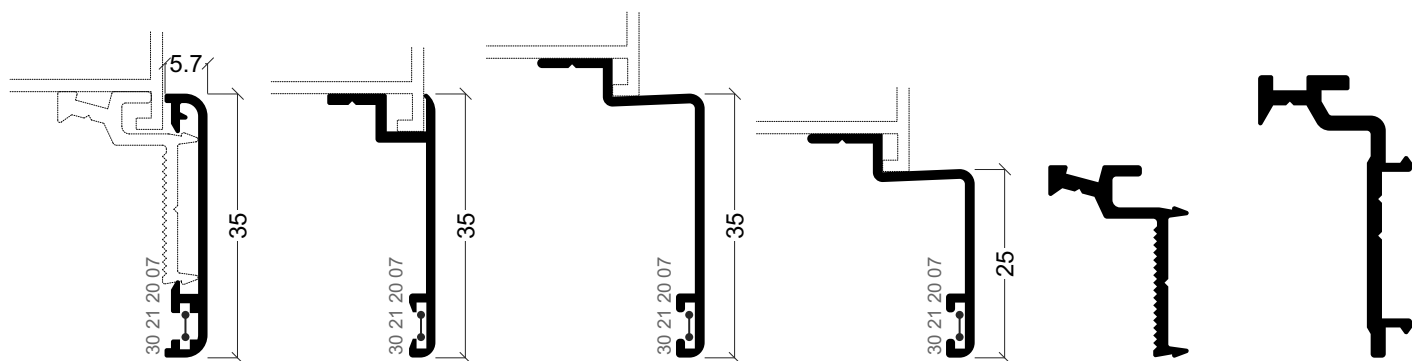

ARi-30
Tapa juntas

ARi-31
Tapa juntas

ARi-37
Tapa juntas

ARi-66
Tapa juntas

ARi-24
Mola tapa juntas

ARi-26
Mola tapa juntas

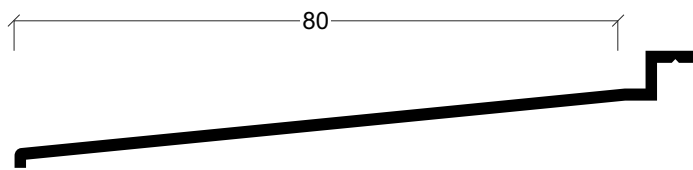

AZ-30
Pingadeira 80 mm

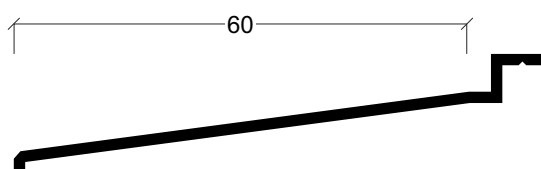

AZ-23
Pingadeira 60 mm

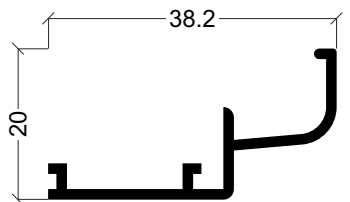

ARi-32
Complemento condensação



AXi-32
Complemento abertura projectante

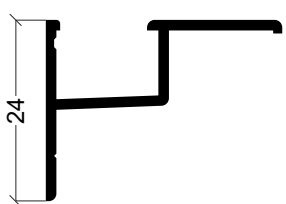

Y-20
Recolha de águas condensação

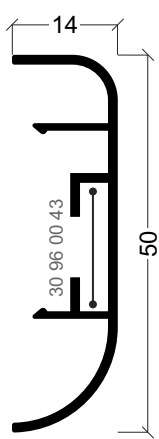

ARi-27
Tapa juntas

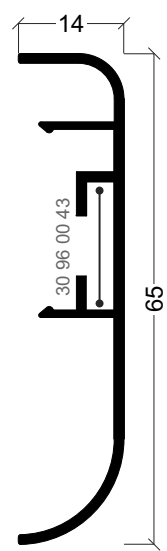

ARi-34
Tapa juntas

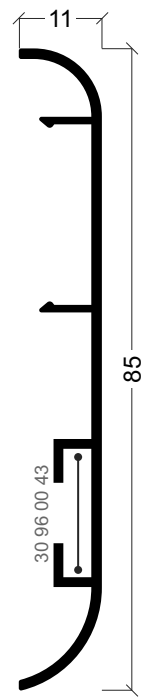

ARi-28
Tapa juntas

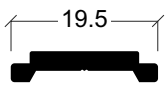

AX-19
Vareta



AX-33
Mola Bite

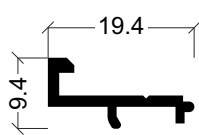

ARi-29
Apoio bite ARi-07

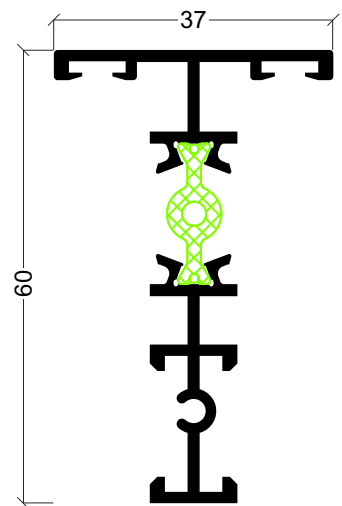

ARi-40
Divisor de vidro

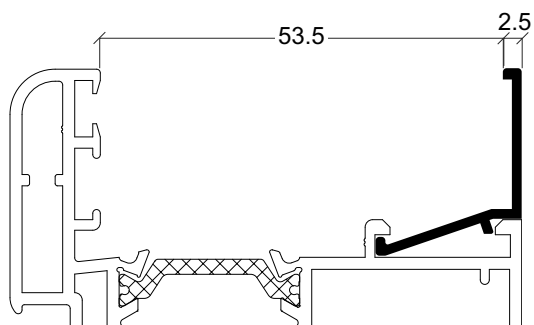

AX-69

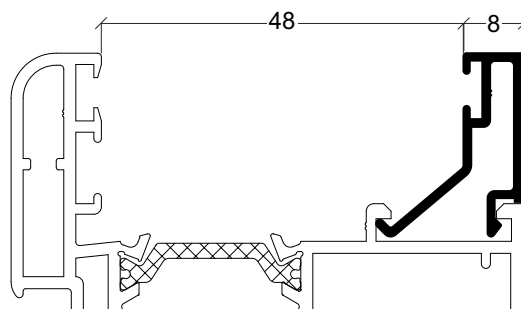

AX-74

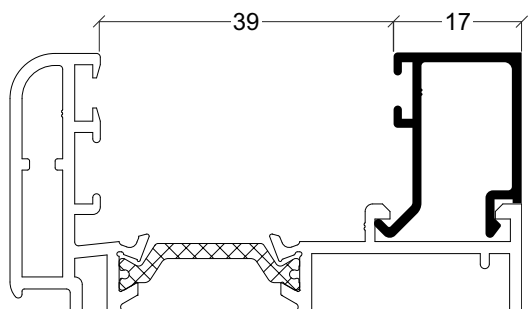

AX-46

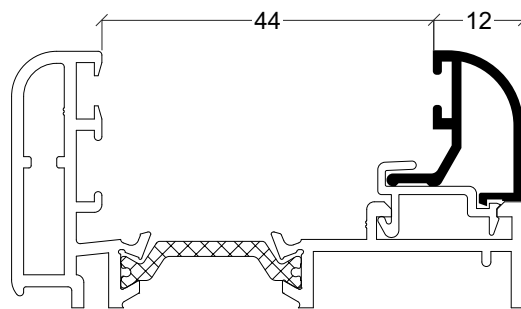

AX-37

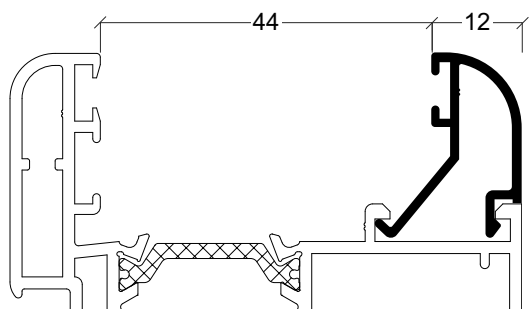

AZ-08

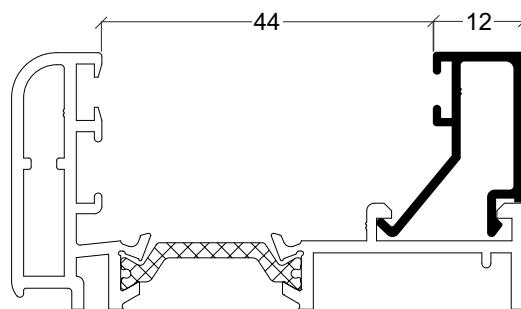

AX-36

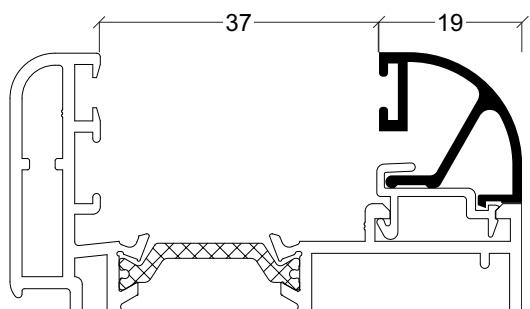

AX-30

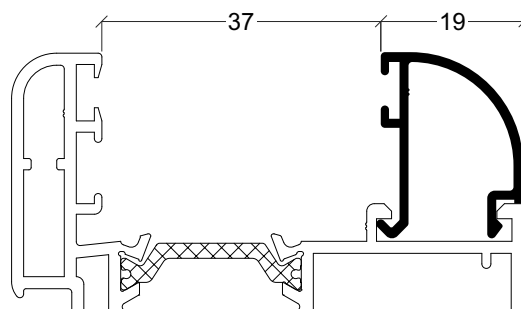

AZ-07

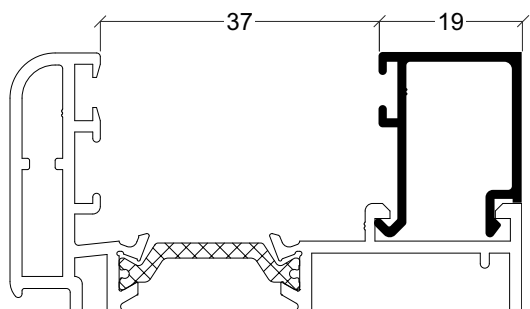

AX-35

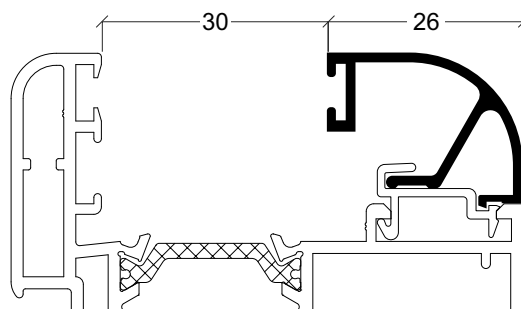

AX-29

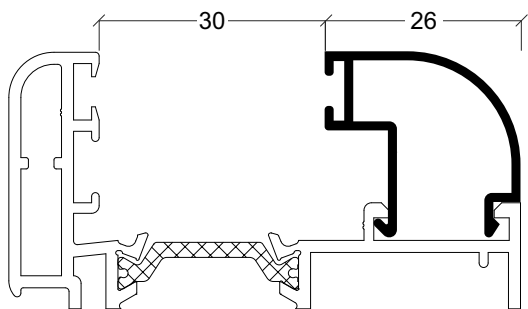

AZ-06

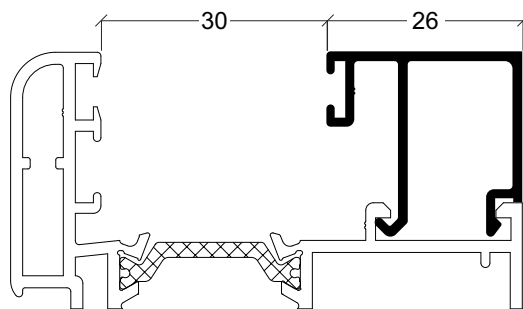

AX-31

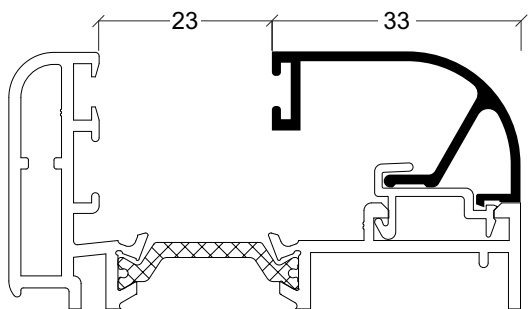

AX-39

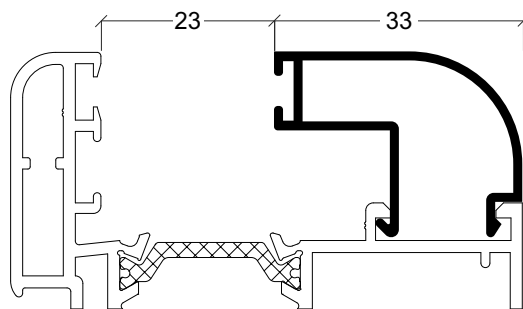

AZ-28

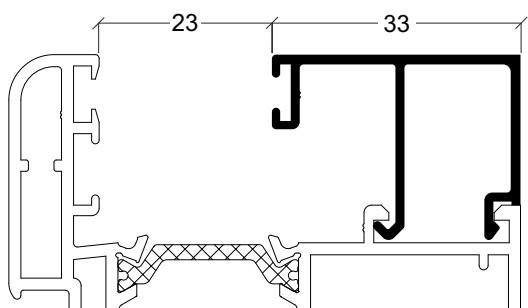

AX-34

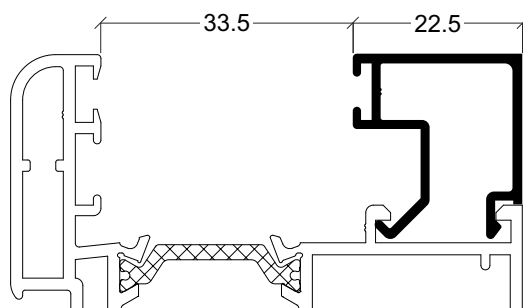

AX-78

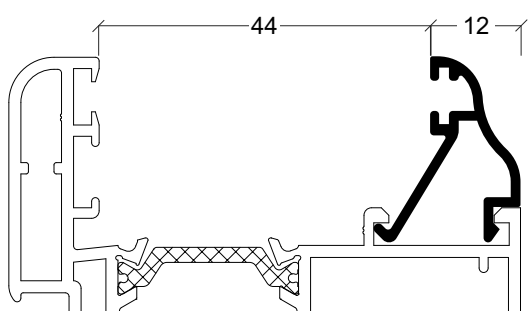

AX-73

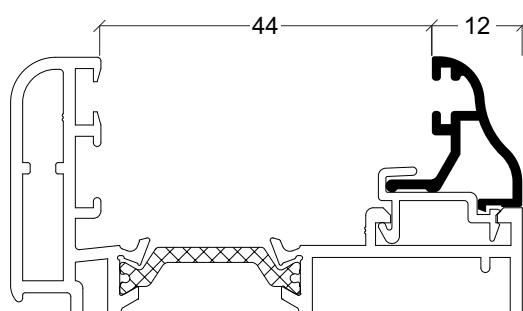

AX-72

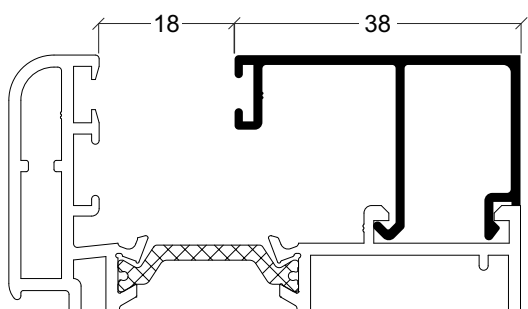

AX-32

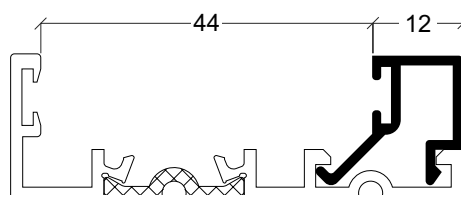

AX-70

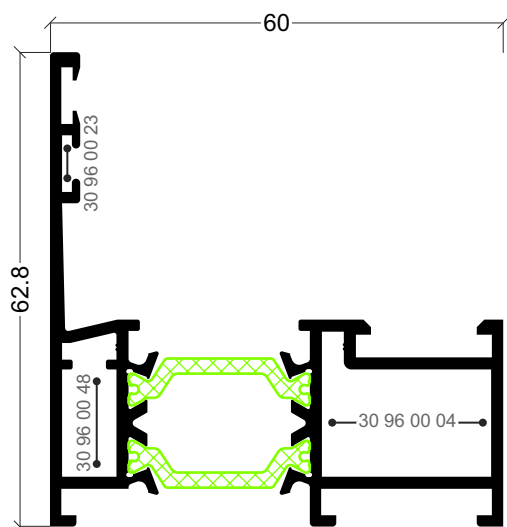

ARI-43
Aro fixo folha oculta

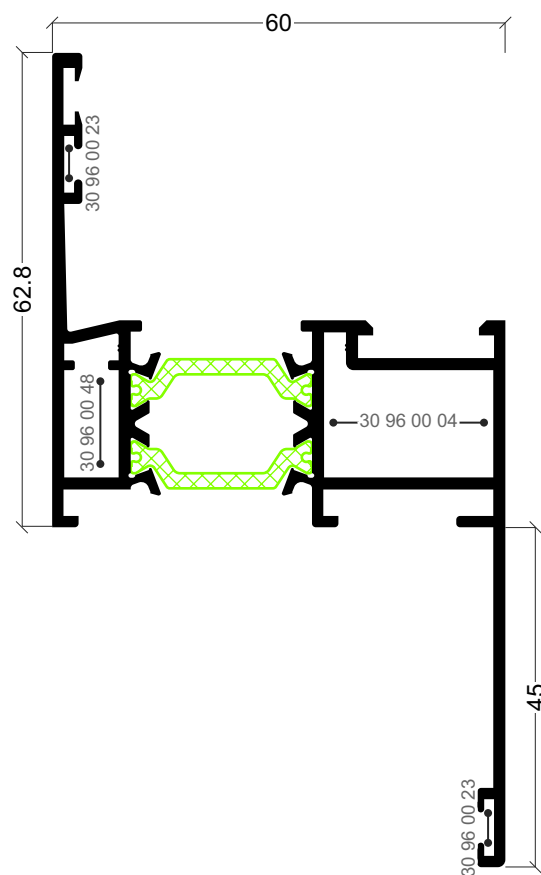

ARI-42
Aro fixo com remate folha oculta

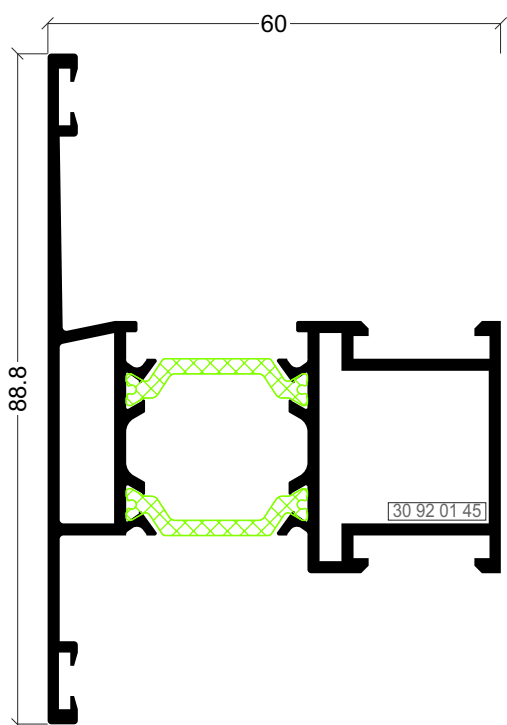

ARI-41
Travessa folha oculta

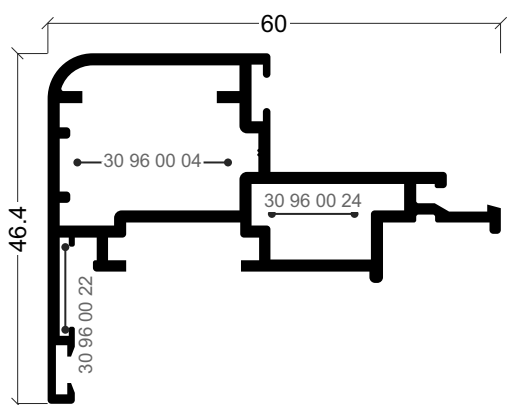

ARI-45
Aro móvel folha oculta

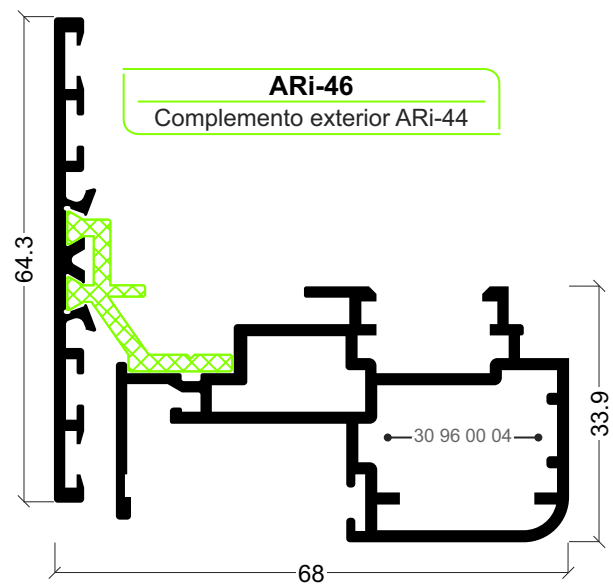

ARI-46
Complemento exterior ARI-44

ARI-44
Aro móvel inversor folha oculta

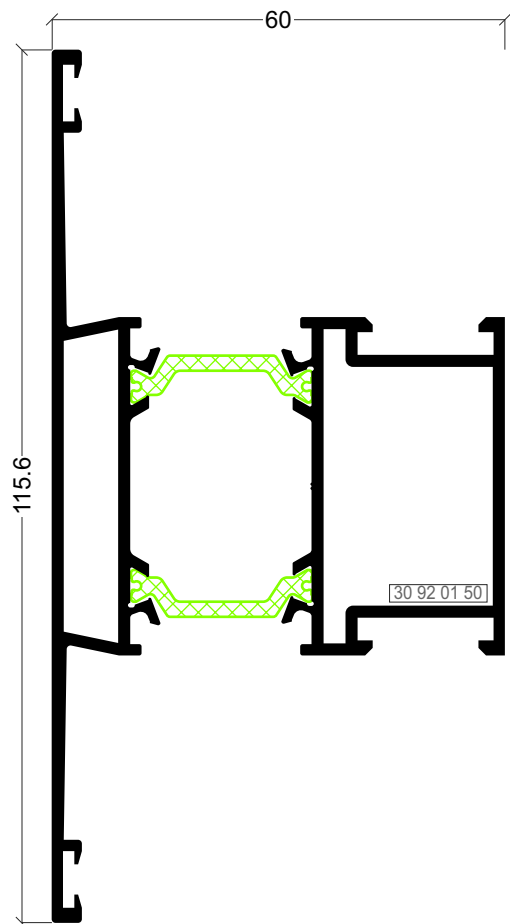

ARi-70
Travessa

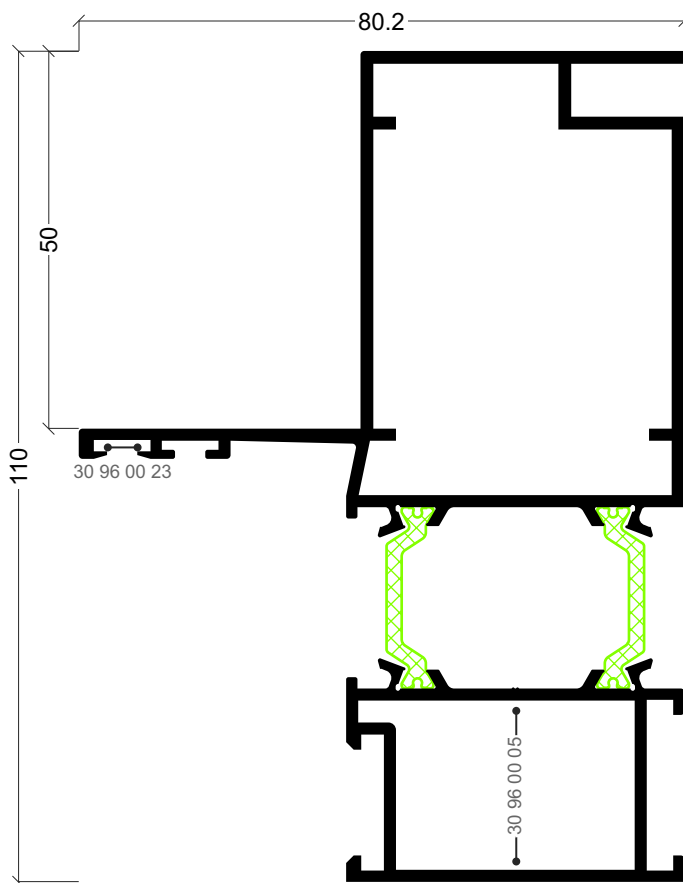

ARi-55
Aro fixo montante

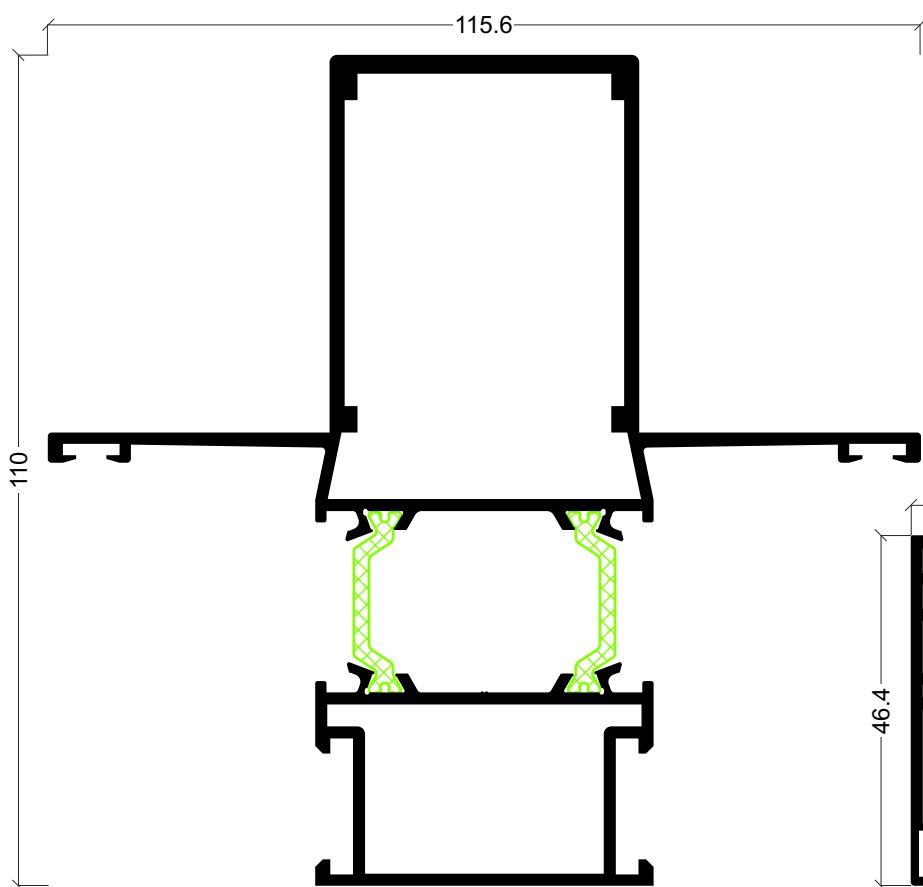

ARi-54
Montante

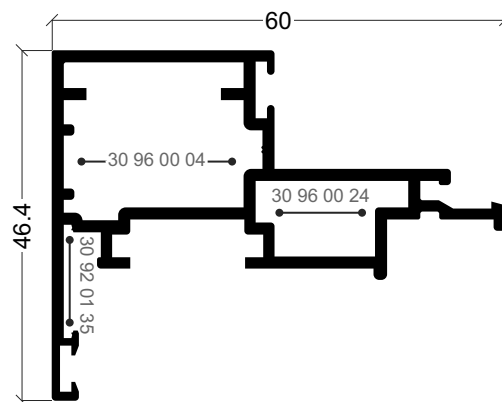

ARi-71
Móvel para vãos de 1 folha ou 1 folha + fixo

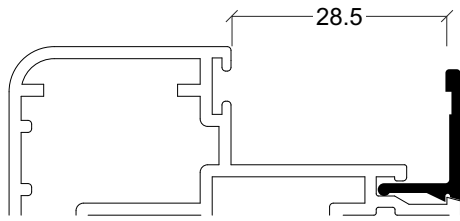

ARi-47

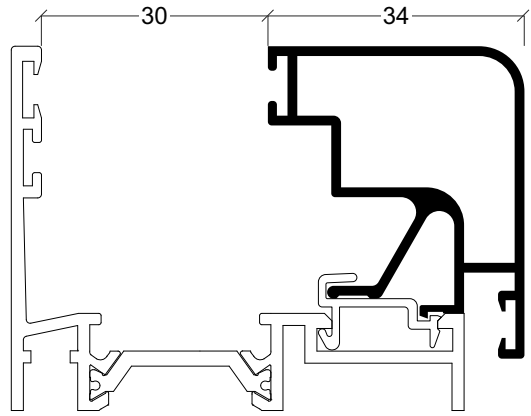

ARi-53

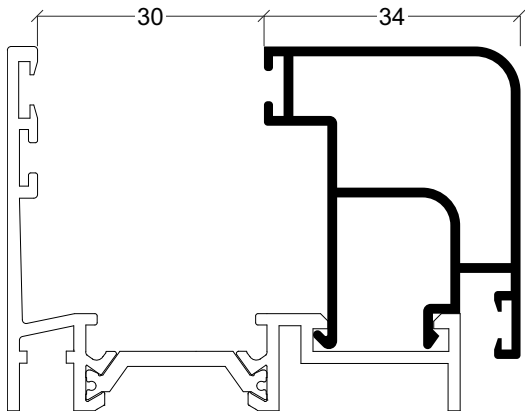

ARi-52

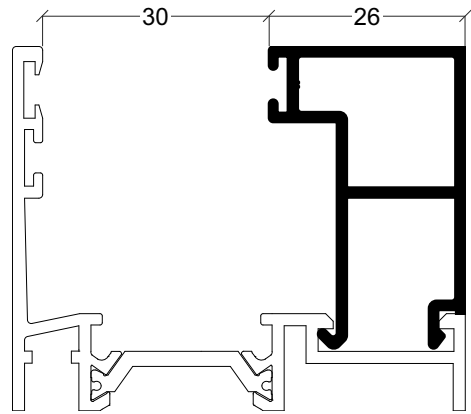

ARi-48

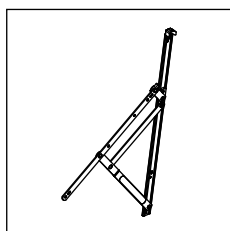

30 00 95 71

Compasso projectante
deslizante até 100 kg/folha

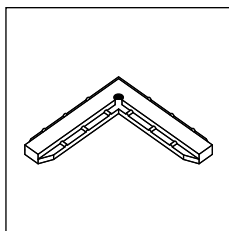

30 21 20 07

Esquadro de
alinhamento

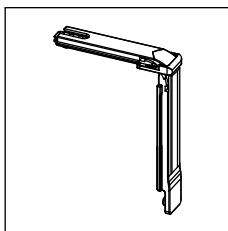

30 90 20 42

Ângulo de reenvio

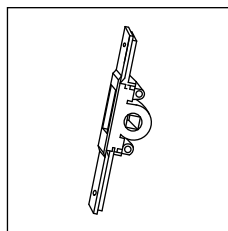

30 90 20 44

Transmissão para
abertura exterior

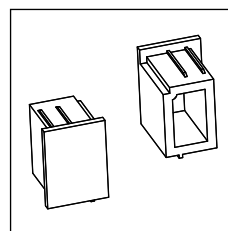

30 91 21 20

Jogo topos condensação
para Y-20

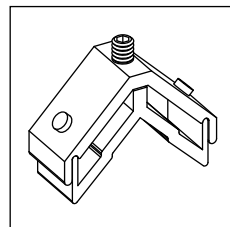

30 91 40 15

Esquadro aro fixo ARI-38

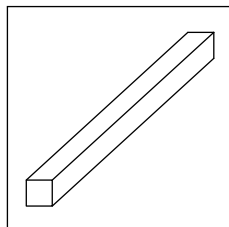

30 91 41 23

Perno 7x131 mm

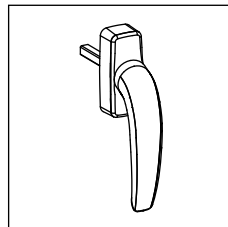

30 91 41 47/48

Cremone pivotante especial
branco/preto

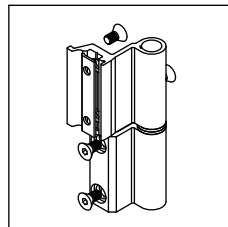

30 92 00 20/21

Dobradiça C.E. branco/
preto

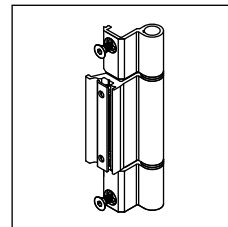

30 92 00 26/27/28

Dobradiça três nós
(bruto/branco/preto)

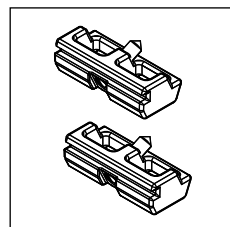

30 92 00 50

Contra-fecho

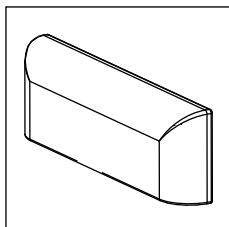

30 92 01 00/01

Goteiras preto/branco

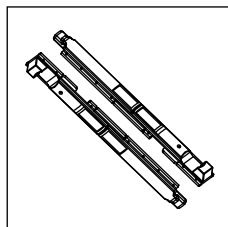

30 92 01 20

Jogo fecho C.E.

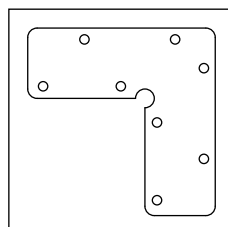

30 92 01 35

Esquadro alinhamento
móvel

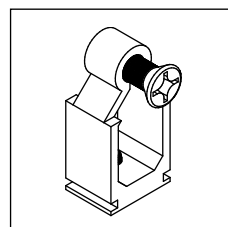

30 92 01 40

União topos janela

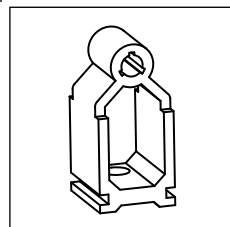

30 92 01 45

União topos janela folha
oculta

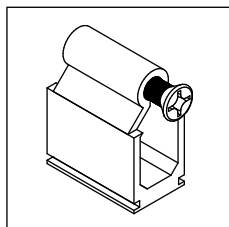

30 92 01 50

União topos porta

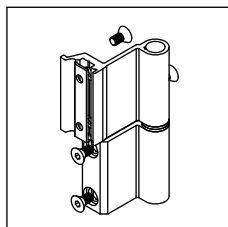

30 92 01 70/80

Dobradiça 3 folhas
branco/preto

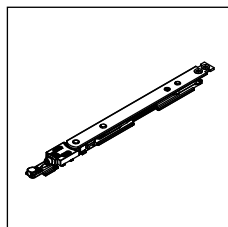

30 92 02 10/11/12

Compasso oscilo
300/400/500

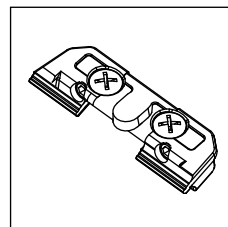

30 92 02 15

Fecho para micro-
ventilação

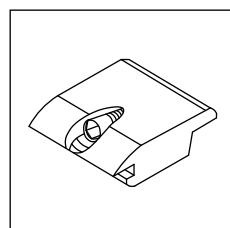

30 92 02 60

Apoio da folha

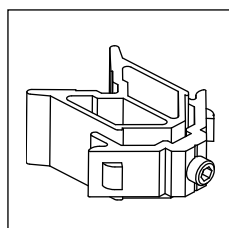

30 92 03 90

Esquadro porta

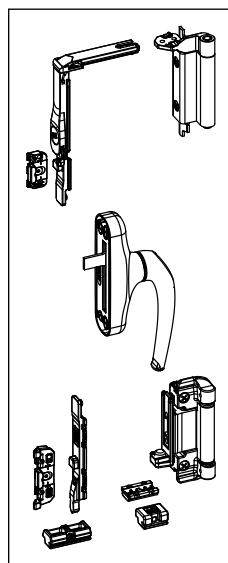

30 92 02 20/21

Kit oscilobatente branco/
preto

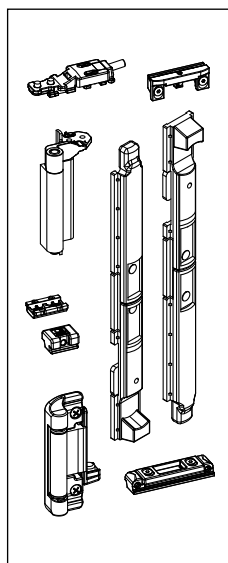

30 92 02 24/25

Kit 2ª folha OB branco/
preto

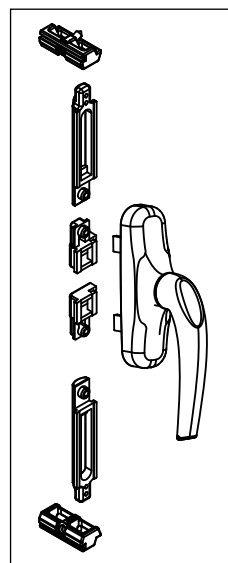

30 92 03 10/11

Kit cremone branco/preto

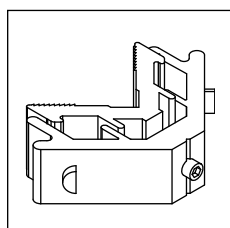

30 92 04 25

Esquadro ARI-80

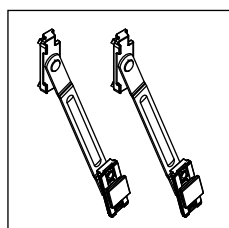

30 92 04 75

Jogo compasso
basculante

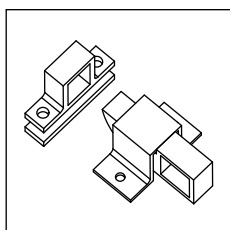

30 92 04 76/77

Fecho clack (branco/ preto)

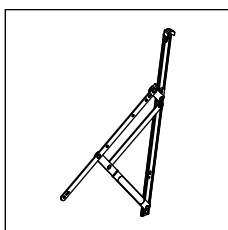

30 92 04 80

Compasso projectante deslizante até 50 kg/folha

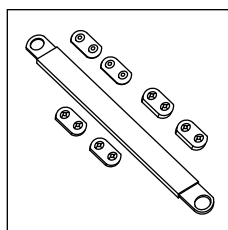

30 92 04 85

Jogo compasso

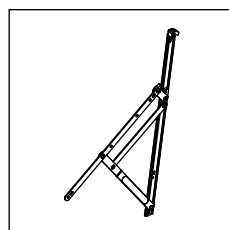

30 92 04 90

Compasso projectante deslizante até 70 kg/folha

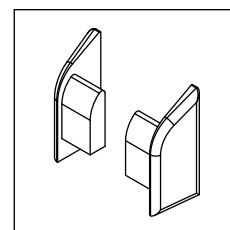

30 92 05 00

Jogo topos

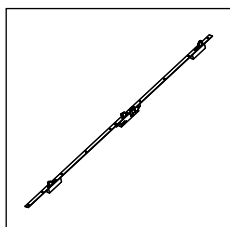

30 92 05 10

Fechadura 3 pontos (35 mm)

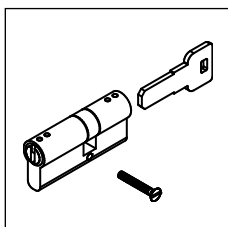

30 92 05 50

Canhão fechadura

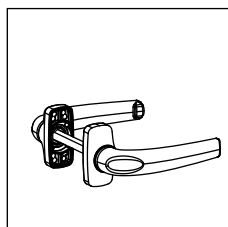

30 92 05 60/61

Puxador duplo branco/ preto

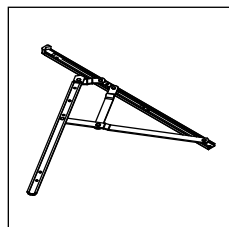

30 92 06 00

Compasso projectante deslizante até 20 kg/folha

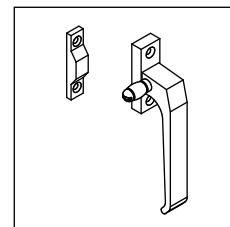

30 92 06 10/11

Cremone de lingueta branco/preto

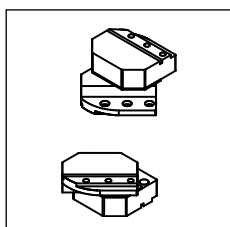

30 92 07 12

Jogo pivotante vertical especial ARi preto (130 kg)

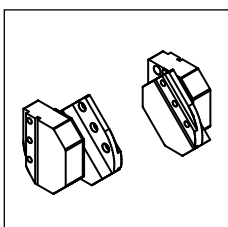

30 92 07 13

Jogo pivotante horizontal especial ARi preto (130 kg)

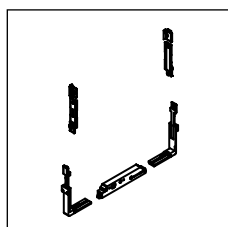

30 92 07 16

Fecho perimetral pivotante especial

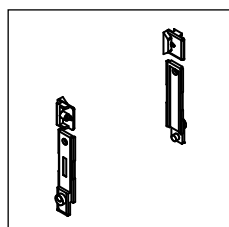

30 92 07 17

Fecho suplementar pivotante especial

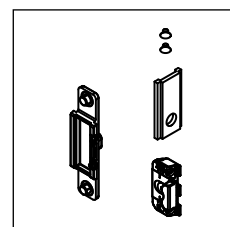

30 92 22 43

Ponto fecho suplementar

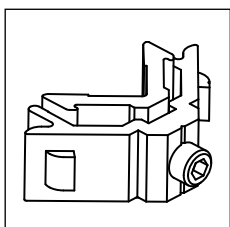

30 96 00 04

Esquadro janela

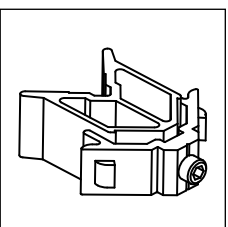

30 96 00 05

Esquadro aro fixo porta

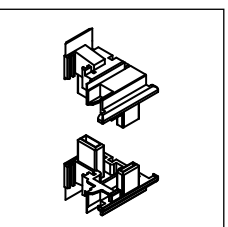

30 96 00 08

Jogo topos inversor ARi

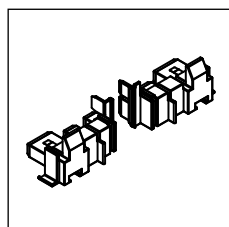

30 96 00 10

Jogo topos ARi-23

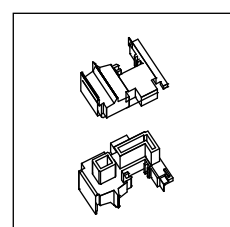

30 96 00 11

Jogo topos inversor abertura exterior ARi-15

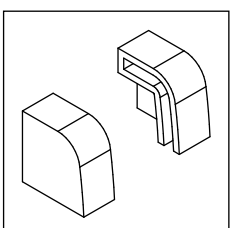

30 96 00 12

Jogo topos condensação

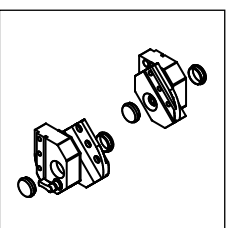

30 96 00 13

Jogo pivotante (60 kg)

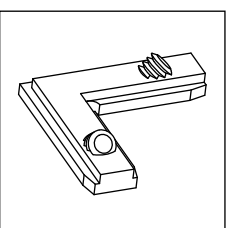

30 96 00 15

Esquadro alinhamento móvel

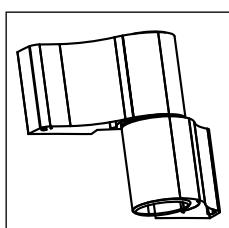

30 96 00 16/20

Dobradiça lisa (branco/ preto)

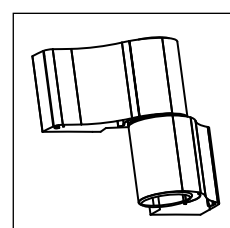

30 96 00 17/21

Dobradiça com ressalto (branco/preto)

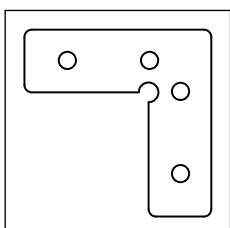

30 96 00 22

Esquadro alinhamento especial

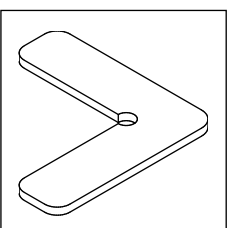

30 96 00 23

Esquadro alinhamento aro fixo

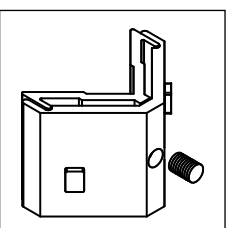

30 96 00 24

Esquadro exterior móvel folha oculta

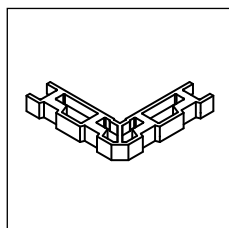

30 96 00 25

Esquadro exterior aro fixo

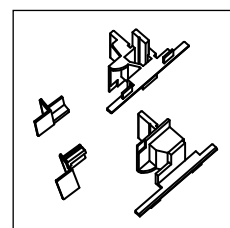

30 96 00 26

Jogo topos inversor folha oculta

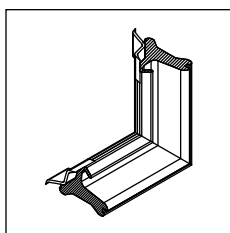

30 96 00 35

Canto vulcanizado

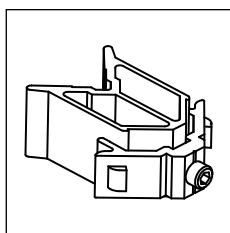

30 96 00 36

Esquadro aro móvel porta

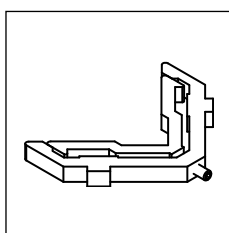

30 96 00 38

Esquadro alinhamento móvel janela

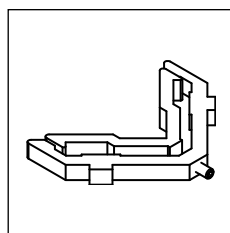

30 96 00 39

Esquadro para alinhamento fixo janela

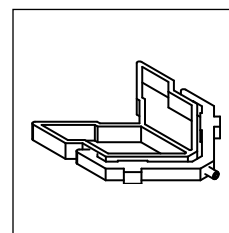

30 96 00 40

Esquadro alinhamento aro fixo porta

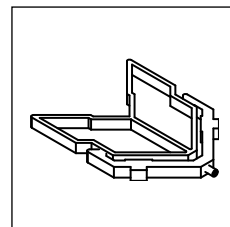

30 96 00 41

Esquadro alinhamento aro móvel porta

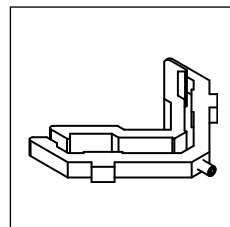

30 96 00 42

Esquadro perfil ARI-07

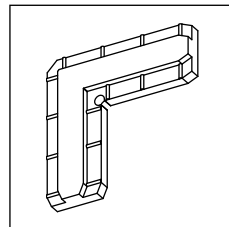

30 96 00 43

Esquadro alinhamento

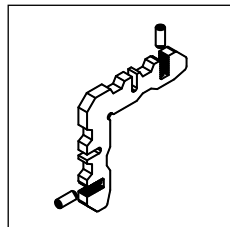

30 96 00 45

Esquadro de alinhamento 5.2x14 com parafusos

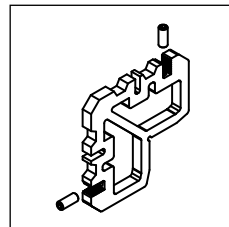

30 96 00 46

Esquadro de alinhamento 5.2x36 com parafusos

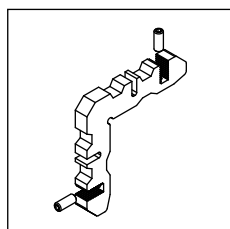

30 96 00 48

Esquadro de alinhamento 7x14 c/ parafusos

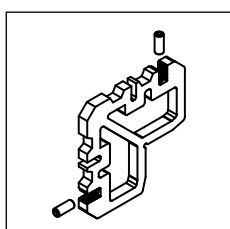

30 96 00 49

Esquadro de alinhamento aro fixo com parafusos

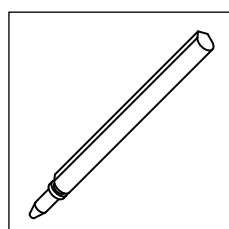

30 96 00 55

Perno alternativo para fixação de esquadro

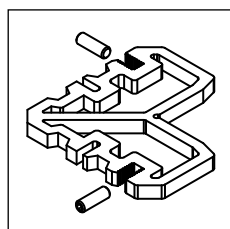

30 96 00 60

Esquadro de alinhamento 5.2x31.6 com parafusos

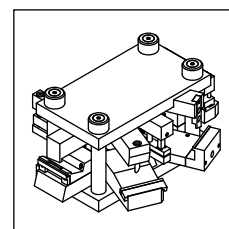

33 96 79 99

Cunho C.E.

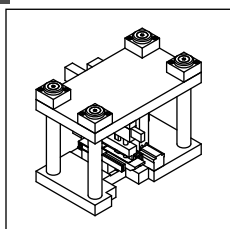

33 96 87 99







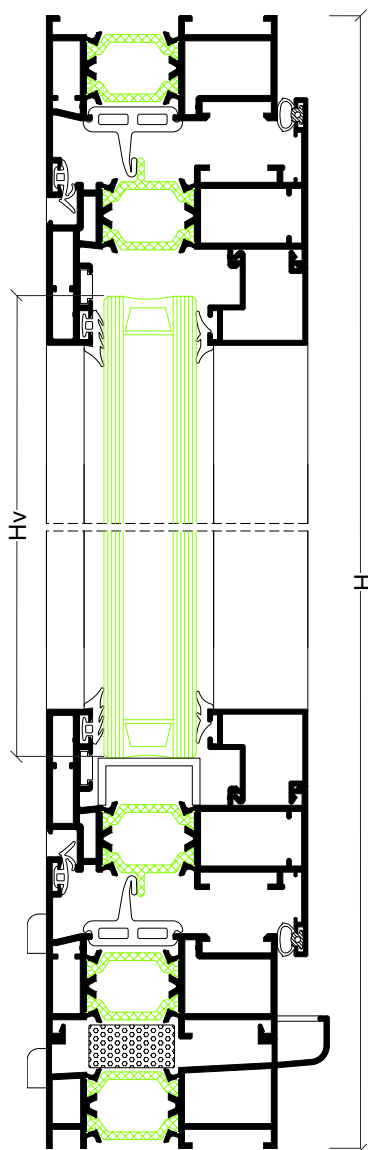
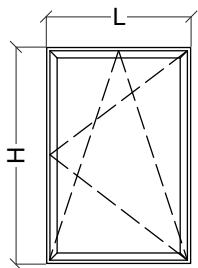







Cunho esquadro interior e exterior ARI/AKi

Referência	Desenho	Descrição
30 00 95 15		Junta vedação interior curta
30 20 30 03		Junta isolante
30 20 70 03		Pelúcia remate porta 11x12 mm
30 92 04 70		Espuma isolante
30 93 00 60		Vedante exterior de vidro (opcional)
30 93 00 61		Junta vedação exterior vidro 2 mm
30 93 00 62		Junta plana para vidro
30 93 00 65		Junta interior para vidro (5 mm)
30 93 00 66		Junta interior para vidro (4 mm)
30 93 00 67		Junta interior para vidro (2 mm)
30 93 00 68		Junta interior para vidro (6/7 mm)
30 93 00 69		Junta interior para vidro (8/9 mm)
30 93 00 70		Vedante interior de vidro (opcional)
30 93 00 80		Junta de vedação inferior ARI-42
30 93 00 82		Junta vedação inferior
30 93 01 20		Junta interior
30 93 01 30		Junta exterior (abertura exterior/projectante)
30 95 00 10		Pelúcia 7x9 mm
30 96 00 02		Junta exterior
30 96 00 03		Junta central
30 96 00 09		Junta central abertura exterior (ARi-25) ou tapa-canal
30 96 00 18		Junta interior (abertura projectante/deslizante)
30 96 00 27		Junta exterior folha oculta

Janela 1 folha abrir e oscilo-batente



Perfis

Desenho	Ref	Descrição	Corte	Quant	Medida
	ARi-03	Aro fixo		2	L
				2	H-28.5 mm
	ARi-61	Aro móvel		2	L-43 mm
				2	H-71.5 mm
	---	Bite		2	L-132 mm
				2	H-200.5 mm
	CT-11	Soleira condensação		1	L
	AZ-23	Pingadeira 60 mm		1	L
	AX-19	Vareta		1+1	Apro. H+L

Acessórios e Juntas

Referência	Descrição	Quantidade	
		Abrir	Oscilo-batente
30 92 00 20	Dobradiças C.E.	2	---
30 92 01 00	Goteiras	4	4
30 92 02 XX	Compasso O.B.	---	1
30 92 02 20	Kit oscilo-batente	---	1
30 92 02 60	Apoio da folha	1	---
30 92 03 10	Kit cremone	1	---
30 96 00 04	Esquadro janela	8	8
30 96 00 48	Esquadro alinhamento aro fixo	4	4
30 96 00 12	Jogo topos condensação	1	1
30 96 00 15	Esquadro alinhamento móvel	4	4
30 96 00 22	Esquadro alinhamento móvel	4	4
30 96 00 45	Esquadro alinhamento exterior móvel	4	4
30 96 00 35	Canto vulcanizado	4	4
30 92 04 70	Espuma isolante	L	
30 96 00 02	Junta exterior	2L+2H	
30 96 00 03	Junta central	2L+2H	
30 93 01 20	Junta interior	2L+2H	
---	Junta exterior vidro	2L+2H	
---	Junta interior vidro	2L+2H	

81

Vidro

Hv = H-174 mm	Lv = L-146 mm
---------------	---------------

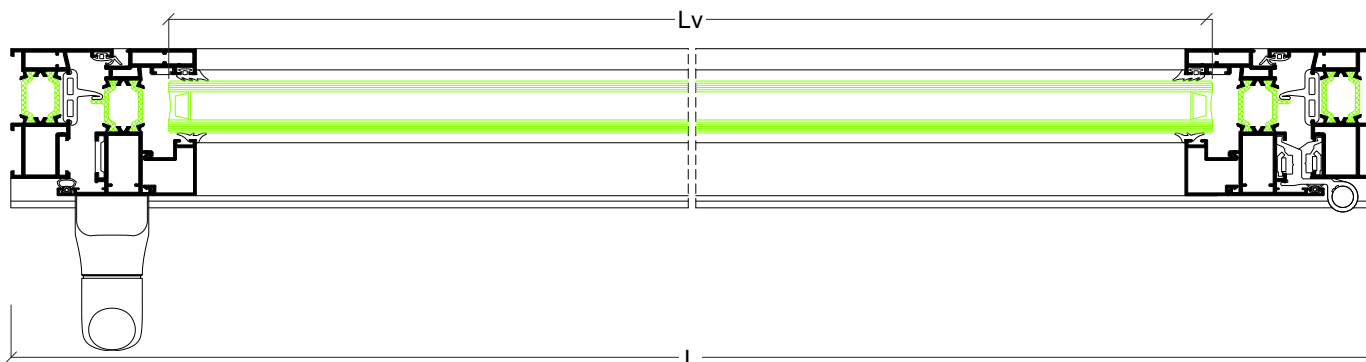

Janela 2 folhas abrir e oscilo-batente

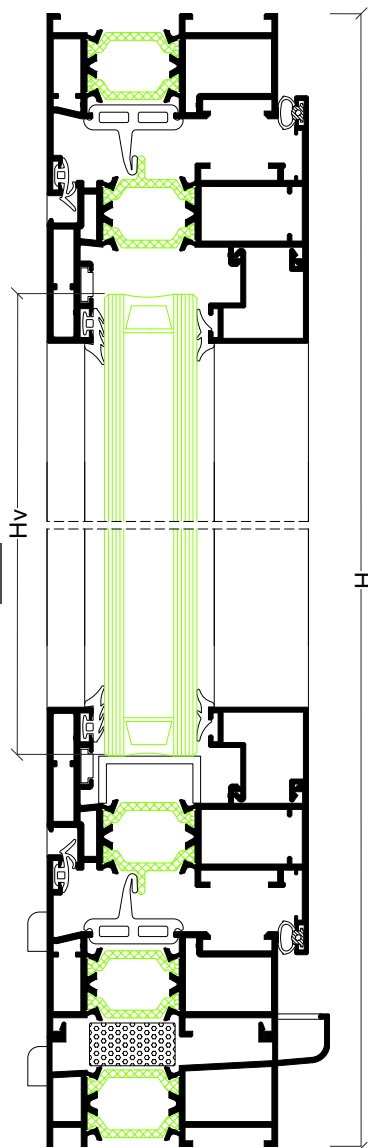
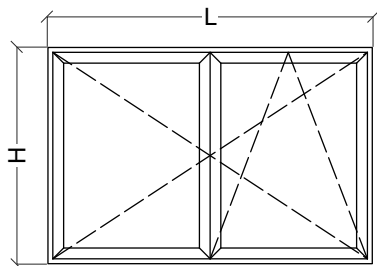

Perfis

Desenho	Ref	Descrição	Corte	Quant	Medida
	ARi-03	Aro fixo		2	L
				2	H-28.5 mm
	ARi-61	Aro móvel		2	L/2-24 mm
				2	H-71.5 mm
	ARi-04	Inversor		1	H-139.5 mm
	---	Bite		4	L/2-113 mm
				4	H-200.5 mm
	CT-11	Soleira condensação		1	L
	AX-19	Vareta		1+1	Apro. H+L

Acessórios e Juntas

Referência	Descrição	Quantidade	
		Abrir	Oscilo-batente
30 92 00 20	Dobradiças C.E.	4	---
30 92 01 00	Goteiras	4	4
30 92 01 20	Jogo fecho C.E.	1	---
30 92 02 XX	Compasso O.B.	---	1
30 92 02 20	Kit oscilo-batente	---	1
30 92 02 24	Kit 2ª folha oscilo-batente	---	1
30 92 02 60	Apoio da folha	1	---
30 92 03 10	Kit cremone	1	---
30 96 00 04	Esquadro janela	12	12
30 96 00 48	Esquadro alinhamento aro fixo	8	8
30 96 00 08	Jogo topos inversor	1	1
30 96 00 12	Jogo topos condensação	1	1
30 96 00 15	Esquadro alinhamento móvel	8	8
30 96 00 22	Esquadro alinhamento móvel	8	8
30 96 00 45	Esquadro alinhamento exterior móvel	4	4
30 96 00 35	Canto vulcanizado	4	4
30 92 04 70	Espuma isolante	L	
30 96 00 02	Junta exterior	2L+4H	
30 96 00 03	Junta central	2L+3H	
30 93 01 20	Junta interior	2L+4H	
---	Junta exterior vidro	2L+2H	
---	Junta interior vidro	2L+2H	

Vidro

Hv = H-174 mm	Lv = L/2-127 mm
---------------	-----------------

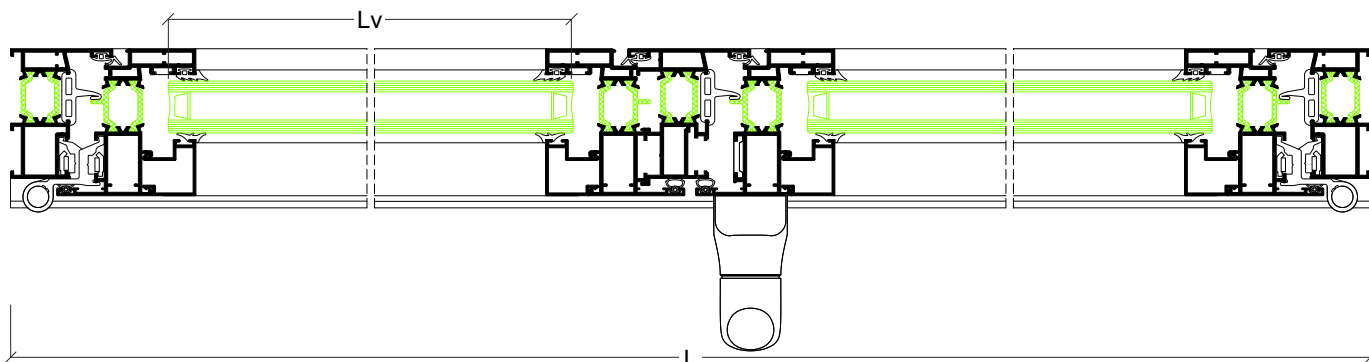

Janela projectante deslizante

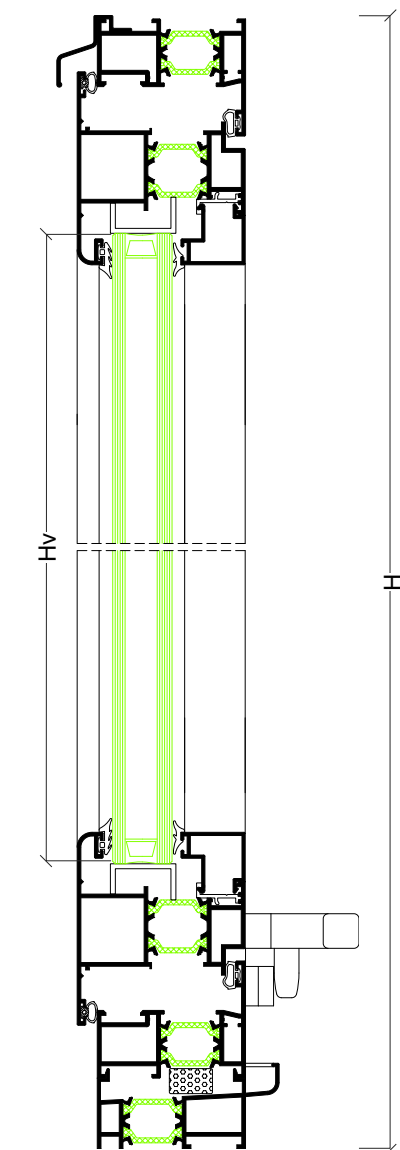
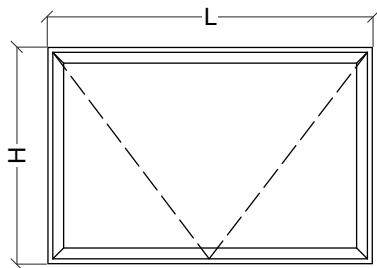

Perfis

Desenho	Ref	Descrição	Corte	Quant	Medida
	ARi-03	Aro fixo		2	L
				2	H-28.5 mm
	ARi-07	Aro móvel abertura projectante deslizante		2	L-43 mm
				2	H-71.5 mm
	---	Bite		4	L-159 mm
				4	H-227.5 mm
	AXi-45	Pingadeira superior		1	L
	AXi-32	Complemento abertura projectante		2	segundo medida compasso
	ARi-29	Apoio bite		2	L-140 mm
				2	H-168.5 mm
	CT-11	Soleira condensação		1	L

Acessórios e Juntas

Referência	Descrição	Quantidade
30 92 01 00	Goteiras	2
30 92 04 10	Esquadro janela	4
30 92 04 90	Jogo compasso projectante deslizante 550	1
30 92 06 10	Cremona de lingueta	2
30 92 04 10	Esquadro janela abertura exterior	4
30 96 00 12	Jogo topos condensação	1
30 96 00 48	Esquadro alinhamento aro fixo	4
30 96 00 42	Esquadro alinhamento interno móvel	4
30 92 04 70	Espuma isolante	L
30 93 01 20	Junta exterior	2L+2H
30 96 00 18	Junta interior projectante deslizante	2L+2H
---	Junta exterior vidro	2L+2H
---	Junta interior vidro	2L+2H

83

Vidro

Hv = H-201 mm	Lv = L-173 mm
---------------	---------------

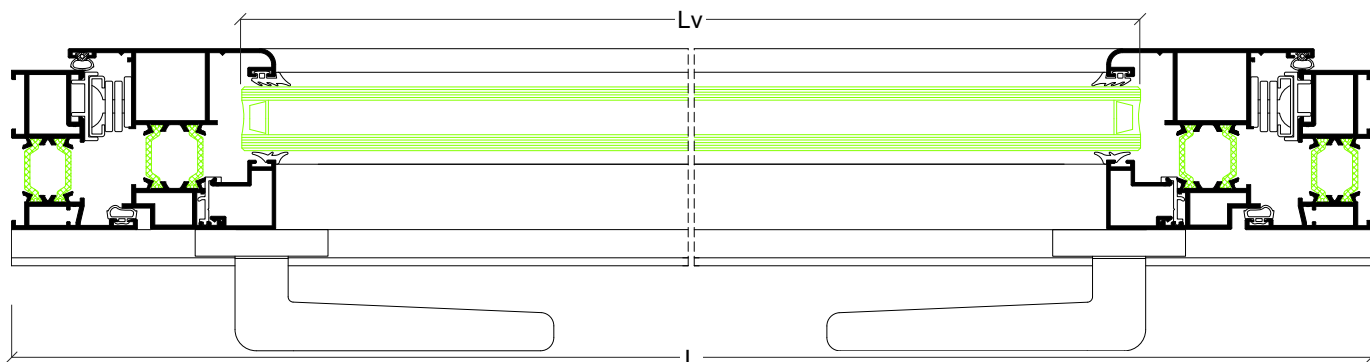

Janela pivotante horizontal

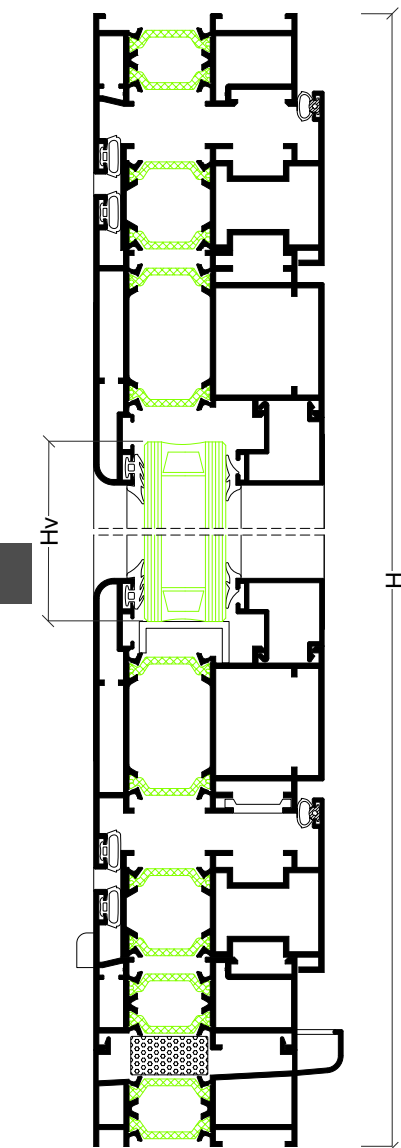
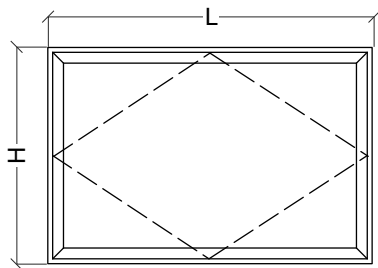

Perfis

Desenho	Ref	Descrição	Corte	Quant	Medida
	ARi-03	Aro fixo		2	L
				2	H-28.5 mm
	ARi-25	Aro móvel abertura exterior		2	L-107 mm
				2	H-135.5 mm
	ARi-14	Inversor pivotante superior		1	L-46 mm
				2	H/2-23 mm
	ARi-14	Inversor pivotante inferior		1	L-46 mm
				2	H/2-51.5 mm
	---	Bite		2	L-239 mm
				2	H-307.5 mm
	CT-11	Soleira condensação		1	L
	AX-19	Vareta		1+1	L+H
				1+1	L+H

Acessórios e Juntas

Referência	Descrição	Quantidade
30 92 01 00	Goteiras	4
30 94 50 10	Esquadro inversor	4
30 96 00 04	Esquadro janela	4
30 96 00 05	Esquadro móvel	4
30 96 00 48	Esquadro alinhamento exterior janela	4
30 96 00 12	Jogo topos condensação	1
30 92 07 13	Jogo pivotante horizontal	1
30 92 07 16	Fecho perimetral pivotante	1
30 96 00 15	Esquadro alinhamento móvel	4
30 96 00 49	Esquadro alinhamento móvel	4
30 91 41 48	Cremones	1
30 92 04 70	Espuma isolante	L
30 96 00 18	Junta exterior	4L+4H
30 93 01 20	Junta interior	2L+2H
---	Junta exterior vidro	2L+2H
---	Junta interior vidro	2L+2H

Vidro

Hv = H-281 mm	Lv = L-253 mm
---------------	---------------

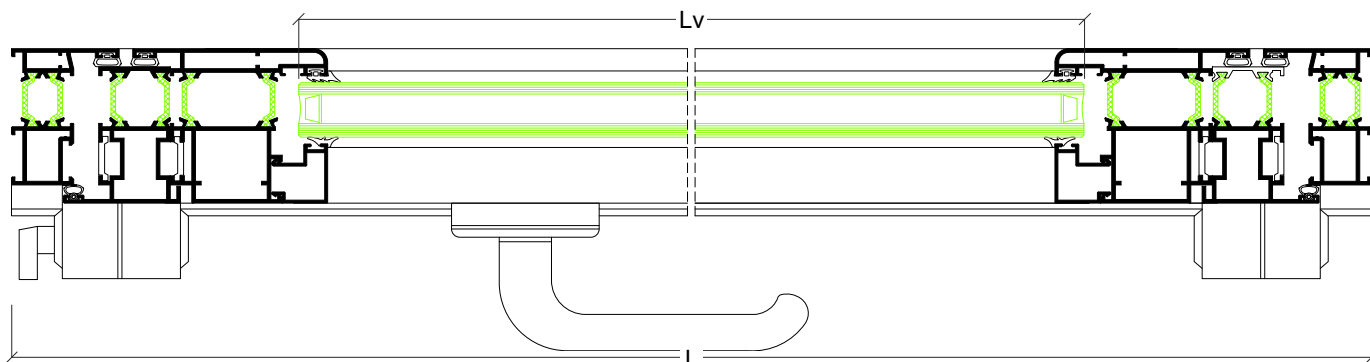

Porta 1 folha

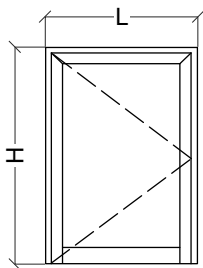

Perfis

Desenho	Ref	Descrição	Corte	Quant	Medida
	ARi-08	Aro fixo		1	L
				2	H
	ARi-36	Aro móvel		2	L-78 mm
				2	H-46 mm
	ARi-23	Almofada		1	L-147 mm
	---	Bite		4	L-216 mm
				4	H-226 mm
	AZ-60	Pingadeira		1	L-148 mm

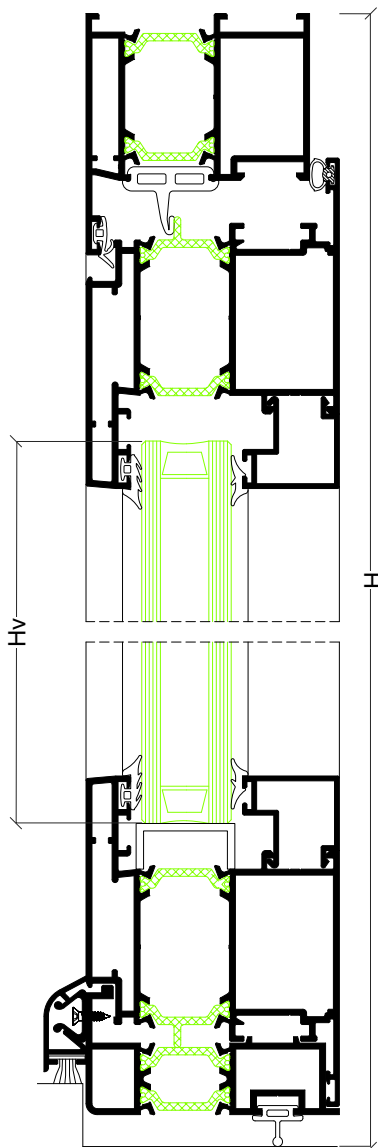

Acessórios e Juntas

Referência	Descrição	Quantidade
30 92 00 20	Dobradiças C.E.	3
30 92 01 35	Esquadro alinhamento móvel	4
30 92 05 10	Fechadura 3 pontos	1
30 92 05 50	Canhão fechadura	1
30 92 05 60	Puxador duplo	1
30 96 00 05	Esquadro aro porta	2
30 96 00 15	Esquadro alinhamento móvel	4
30 96 00 36	Esquadro móvel porta	4
30 96 00 46	Esquadro alinhamento aro móvel porta	4
30 96 00 49	Esquadro alinhamento aro fixo	2
30 96 00 10	Jogo topos ARi-23	1
31 03 40 00	Mola para pingadeira	A cada 200 mm
30 96 00 35	Canto vulcanizado	2
30 92 05 00	Jogo topos AZ-60	1
30 93 00 80	Junta inferior	L
30 96 00 02	Junta exterior	L+2H
30 96 00 03	Junta central	L+2H
30 93 01 20	Junta interior	L+2H
---	Junta exterior vidro	2L+2H
---	Junta interior vidro	2L+2H

85

Vidro

Hv = H-200 mm	Lv = L-230 mm
---------------	---------------

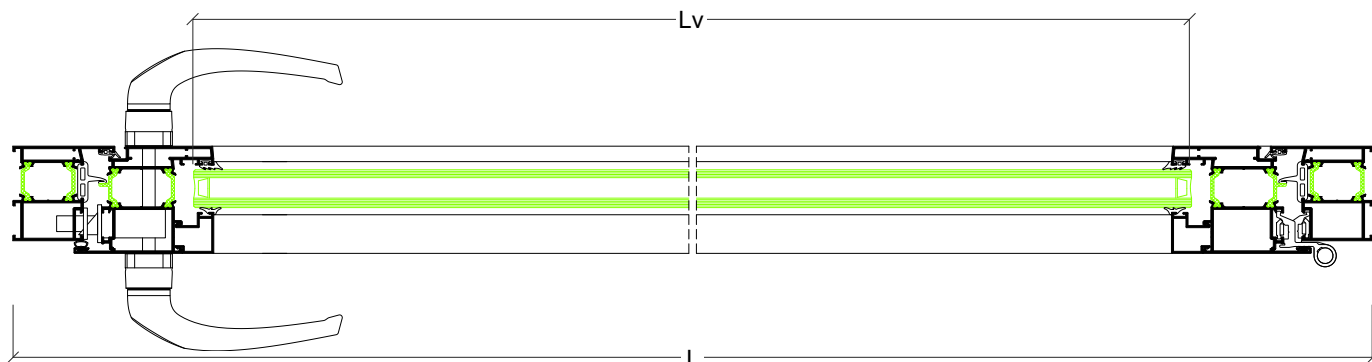

Porta 2 folhas abertura exterior

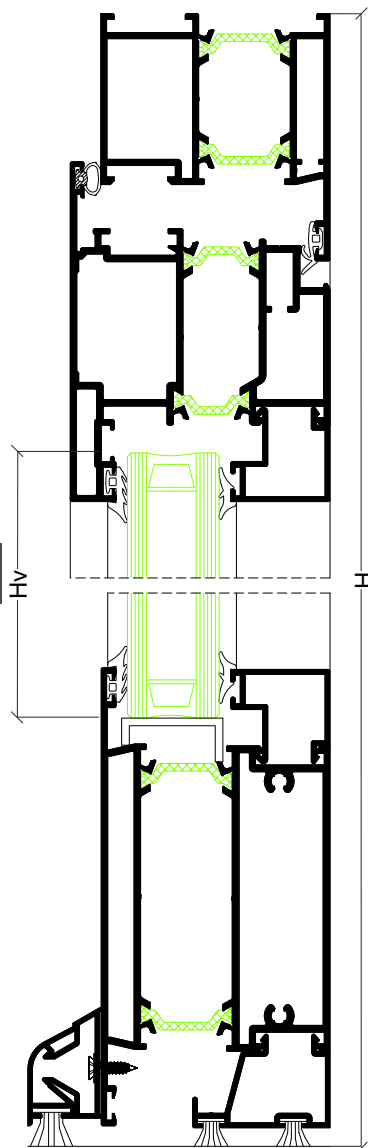
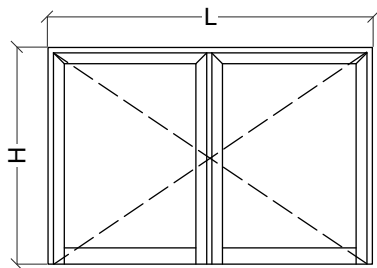

Perfis

Desenho	Ref	Descrição	Corte	Quant	Medida
	ARi-08	Aro fixo		1	L
				2	H
	ARi-72	Aro móvel abertura exterior		2	L/2-41.5 mm
				4	H-44 mm
	ARi-04	Inversor		1	H-78 mm
	ARi-12	Travessa		1	L/2-169.5 mm
	AX-15	Bite remate		2	L/2-160.5 mm
	---	Bite		4	L/2-179 mm
				4	H-253 mm
	AZ-60	Pingadeira		1	L/2-112.5 mm
				1	L/2-43 mm
	AZ-61	Suplemento para pingadeira		2	L/2-219.5 mm

Acessórios e Juntas

Referência	Descrição	Quantidade
30 92 01 20	Jogo fecho C.E.	1
30 92 05 10	Fechadura 3 pontos	1
30 92 05 50	Canhão fechadura	1
30 92 05 60	Puxador duplo	1
30 96 00 05	Esquadro porta	2
30 96 00 08	Jogo topos inversor	1
30 92 00 20	Dobradiça C.E.	6
30 95 00 10	Pelúcia 7x9 mm	2L
30 95 05 00	Jogo topos AZ-60	1
30 92 03 90	Esquadro móvel exterior	4
30 92 01 35	Esquadro alinhamento móvel	4
30 96 00 15	Esquadro alinhamento móvel exterior	4
30 96 00 45	Esquadro móvel interior	4
30 96 00 49	Esquadro móvel exterior	2
30 93 01 20	Junta exterior	2L
30 96 00 02	Junta interior	L+4H
---	Junta exterior vidro	2L+4H
---	Junta interior vidro	2L+4H

Vidro

Hv = H-228 mm	Lv = L/2-194 mm
---------------	-----------------

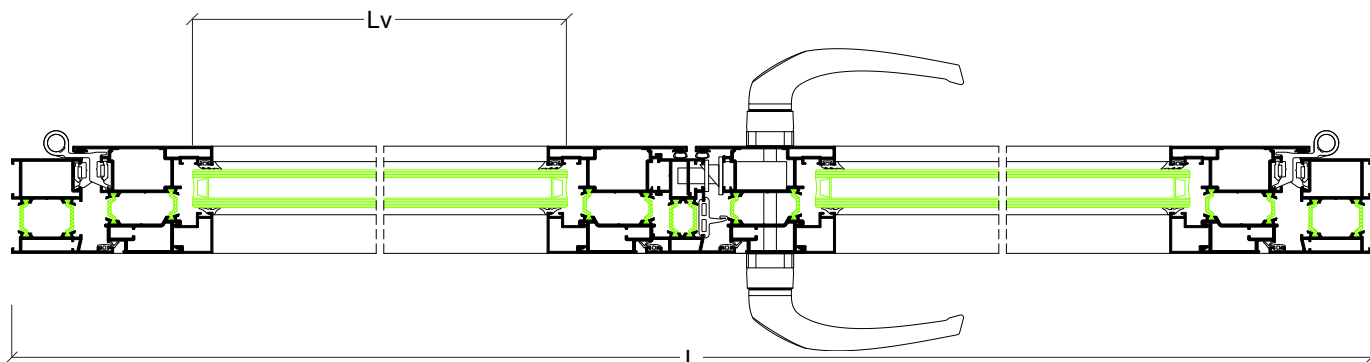

Porta oscilo-paralela com fixo lateral

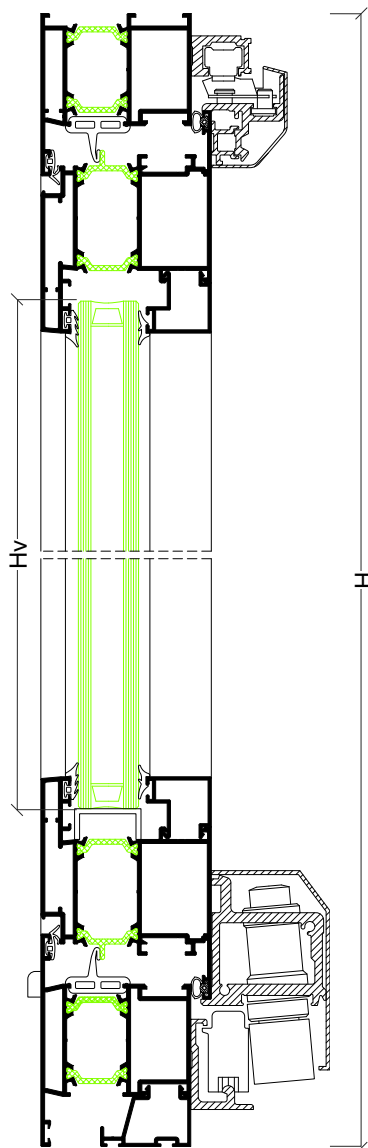
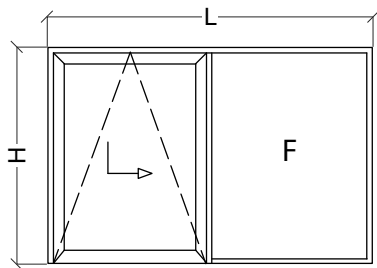

Perfis

Desenho	Ref	Descrição	Corte	Quant	Medida
	ARi-08	Aro fixo		1	L
				2	H
	ARi-06	Travessa		1	L-80.5 mm
				1	H-100.5 mm
	ARi-36	Aro móvel		2	L1-55.5 mm
				4	H-98 mm
	---	Bite (folha)		2	L1-193 mm
				2	H-275.5 mm
	---	Bite (fixo)		2	L2-67.5 mm
				2	H-150 mm
	AX-15	Bite remate		1	L-90 mm
	AX-19	Vareta		1+1	Aprox. L+H

Acessórios e Juntas

Referência	Descrição	Quantidade
30 92 01 00	Goteiras	4
30 92 01 35	Esquadro alinhamento móvel	4
30 92 01 50	União topos porta	4
30 96 00 05	Esquadro aro fixo	2
30 96 00 15	Esquadro alinhamento móvel	4
30 96 00 36	Esquadro aro móvel	4
30 96 00 46	Esquadro alinhamento exterior aro móvel	4
30 96 00 49	Esquadro alinhamento aro fixo	2
---	Kit oscilo-paralela	1
30 96 00 35	Canto vulcanizado	4
30 96 00 02	Junta exterior	2L1+2H
30 96 00 03	Junta central	2L1+2H
30 93 01 20	Junta interior	2L1+2H
---	Junta exterior vidro	2L+2H
---	Junta interior vidro	2L+2H

Vidro

Hv folha = H-249 mm	Lv folha = L1-206 mm	
Hv fixo = H-124 mm	Lv fixo = L2-81 mm	
	Mínimo	Máximo
Largura da folha	700 mm	1650 mm
Altura da folha	850 mm	2400 mm
Peso máximo por folha 150 kg		

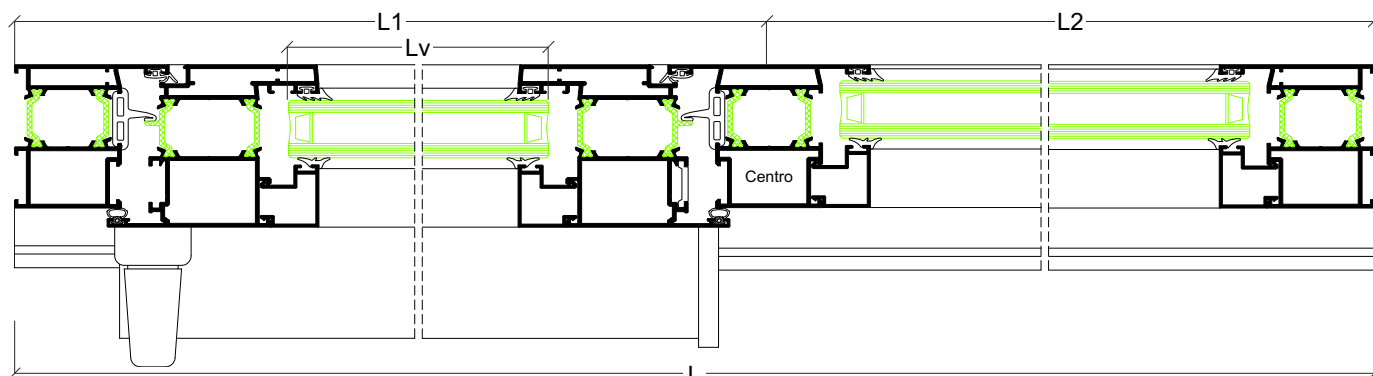

Porta 3 folhas harmónio

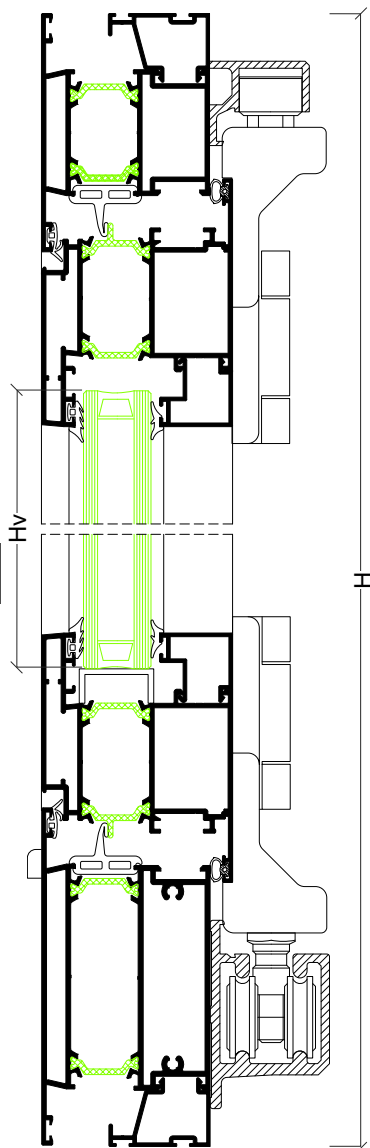
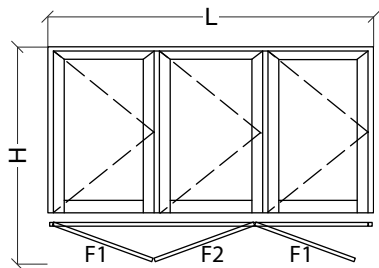

Perfis

Desenho	Ref	Descrição	Corte	Quant	Medida
	ARi-08	Aro fixo		2	H
	ARi-06	Travessa		1	L-80.5 mm
	ARi-12	Travessa		1	L-80.5 mm
	ARi-36	Aro móvel		6	consultar
				6	consultar
	ARi-04	Inversor		2	consultar
	---	Bite (folha)		6	consultar
				6	consultar
	AX-15	Bite remate		2	L-90 mm
	AX-19	Vareta		2	2H

Acessórios e Juntas

Referência	Descrição	Quantidade
30 92 01 00	Goteiras	6
30 92 01 35	Esquadro alinhamento aro móvel	12
30 96 00 08	Jogo topos inversor	2
30 96 00 15	Esquadro alinhamento aro móvel	12
30 96 00 36	Esquadro aro móvel porta	12
30 96 00 46	Esquadro alinhamento exterior aro porta	12
---	Kit harmónio (3+0)	1
30 92 01 50	União topo porta	2
30 92 01 20	Jogo fecho C.E.	1
30 96 00 35	Canto vulcanizado	4
30 96 00 02	Junta exterior	2L+6H
30 96 00 03	Junta central	2L+4H
30 93 01 20	Junta interior	2L+6H
---	Junta exterior vidro	2L+2H
---	Junta interior vidro	2L+2H

Vidro

Hv = consultar	Lv Folha 1 = consultar	
	Lv Folha 2 = consultar	
	Mínimo	Máximo
Largura da folha	600 mm	900 mm
Altura da folha	850 mm	2400 mm
Peso máximo por folha 80 kg		

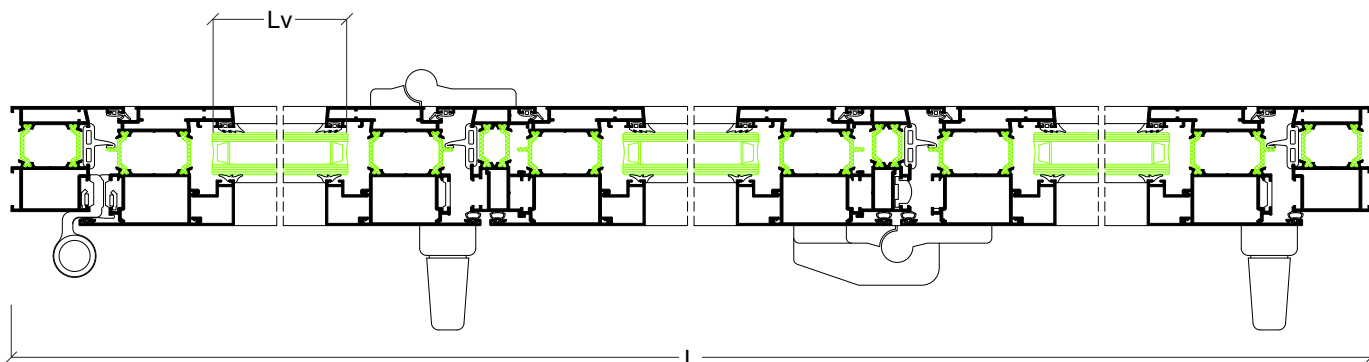

Janela 1 folha abrir e oscilo-batente

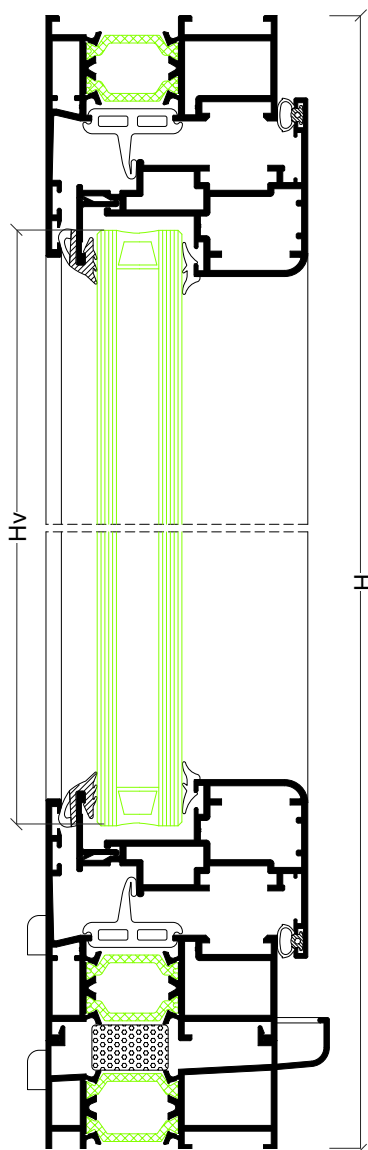
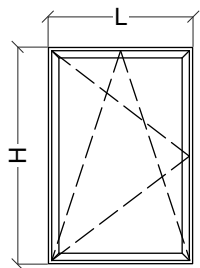

Perfis

Desenho	Ref	Descrição	Corte	Quant	Medida
	ARi-43	Aro fixo folha oclusa		2	L
				2	H-28.5 mm
	ARi-45	Aro móvel folha oclusa		2	L-43 mm
				2	H-71.5 mm
	ARi-47	Bite folha oclusa		2	L-94 mm
				2	H-122.5 mm
	CT-11	Soleira condensação		1	L
	AX-19	Vareta		1+1	L+H

Acessórios e Juntas

Referência	Descrição	Quantidade	
		Abrir	Oscilo-batente
30 92 00 20	Dobradiças C.E.	2	---
30 92 01 00	Goteiras	4	4
30 92 02 XX	Compasso O.B.	---	1
30 92 02 20	Kit oscilo-batente	---	1
30 92 02 60	Apoio da folha	1	---
30 92 03 10	Kit cremone	1	---
30 96 00 04	Esquadro janela	8	8
30 96 00 48	Esquadro alinhamento aro fixo	4	4
30 96 00 12	Jogo topos condensação	1	1
30 96 00 23	Esquadro alinhamento aro fixo	4	4
30 96 00 24	Esquadro alinhamento aro móvel	4	4
30 96 00 22	Esquadro alinhamento interior móvel	4	4
30 96 00 35	Canto vulcanizado	4	4
30 92 04 70	Espuma isolante	L	
30 96 00 27	Junta exterior folha oclusa	2L+2H	
30 96 00 03	Junta central	2L+2H	
30 93 01 20	Junta interior	2L+2H	
---	Junta interior vidro	2L+2H	

89

Vidro

Hv = H-139 mm	Lv = L-110 mm
---------------	---------------

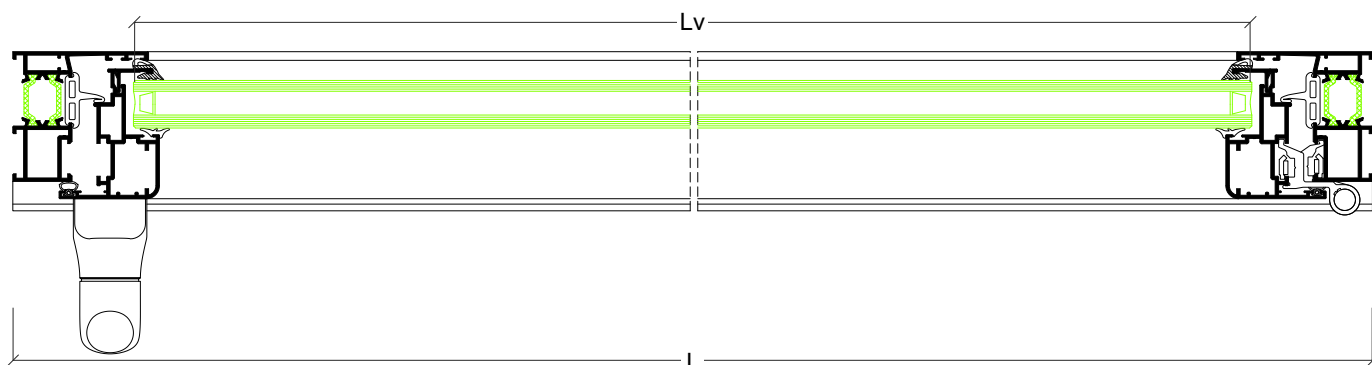

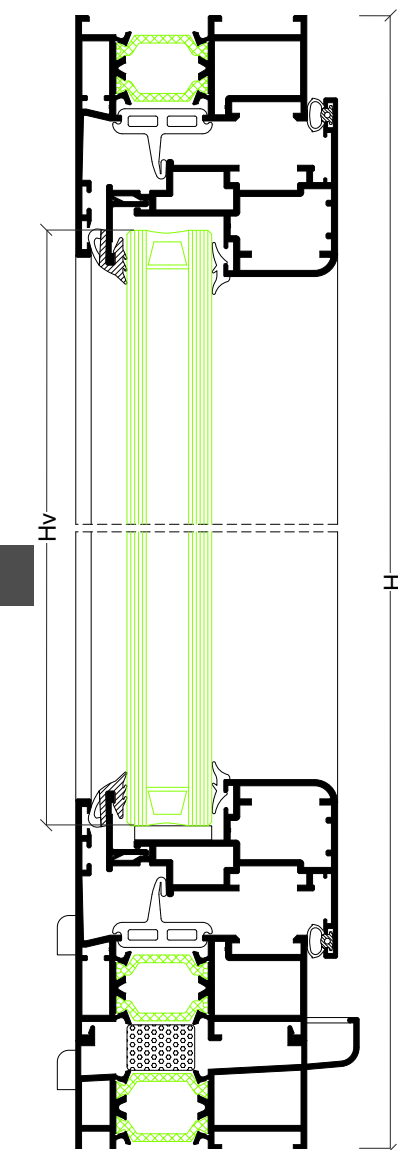
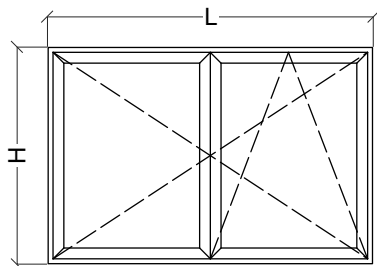
Janela 2 folhas abrir e oscilo-batente

Perfis

Desenho	Ref	Descrição	Corte	Quant	Medida
	ARI-43	Aro fixo folha oculta		2	L
				2	H-28.5 mm
	ARI-45	Aro móvel folha oculta		4	L/2-12 mm
				3	H-71.5 mm
	ARI-46	Complemento aro móvel inversor		1	H-159.5 mm
	ARI-44	Aro móvel		1	H-95.5 mm
	ARI-47	Bite folha oculta		4	L/2-63.5 mm
				3	H-122.5 mm
	CT-11	Soleira condensação		1	L
	AX-19	Vareta		1+1	L+H

Acessórios e Juntas

Referência	Descrição	Quantidade	
		Abrir	Oscilo-batente
30 92 00 20	Dobradiças C.E.	4	---
30 92 01 00	Goteiras	4	4
30 92 01 20	Jogo fecho C.E.	1	---
30 92 02 XX	Compasso O.B.	---	1
30 92 02 20	Kit oscilo-batente	---	1
30 92 02 24	Kit 2ª folha oscilo-batente	---	1
30 92 02 60	Apoio da folha	1	---
30 92 03 10	Kit cremone	1	---
30 96 00 04	Esquadro janela	12	12
30 96 00 48	Esquadro alinhamento aro fixo	4	4
30 96 00 12	Jogo topos condensação	1	1
30 96 00 23	Esquadro alinhamento aro fixo	4	4
30 96 00 24	Esquadro alinhamento aro móvel	8	8
30 96 00 22	Esquadro alinhamento interior móvel	4	4
30 96 00 26	Jogo topos inversor	1	1
30 96 00 35	Canto vulcanizado	4	4
30 92 04 70	Espuma isolante	L	
30 96 00 27	Junta exterior folha oculta	2L+4H	
30 96 00 03	Junta central	2L+3H	
30 93 01 20	Junta interior	2L+3H	
---	Junta interior vidro	2L+4H	

Vidro

Hv = H-139 mm	Lv = L/2-79 mm
---------------	----------------

