

[www.anicolor.pt](http://www.anicolor.pt)

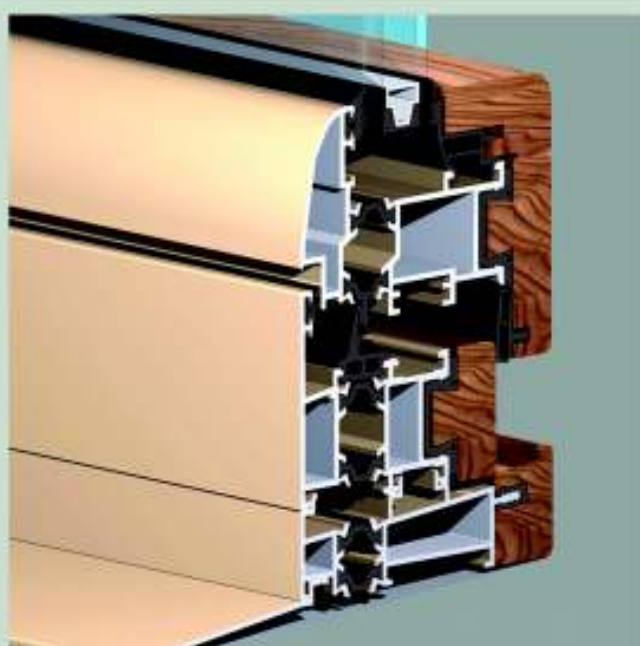
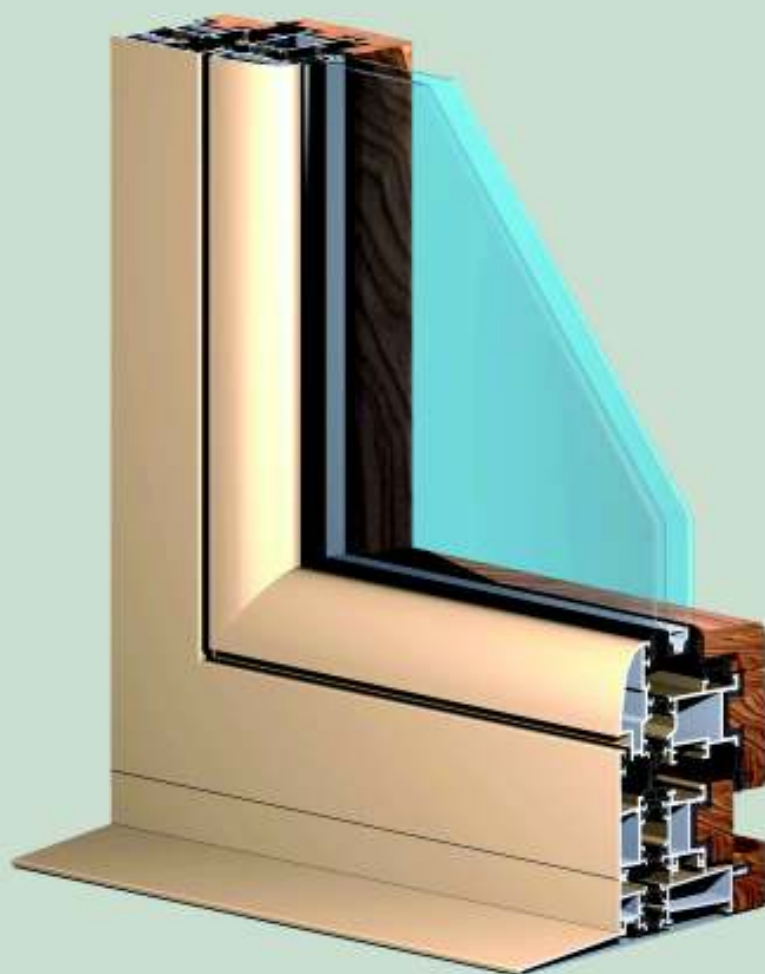

Série  
**AM**

AM

# SISTEMA AM

*Inovador sistema de batente com Rotura Térmica que combina na perfeição as prestações do alumínio no exterior, com a nobreza e qualidade da madeira no interior.*

*As secções interior-exterior do aro e móvel são respectivamente de 68,9mm e 88,4mm com uma espessura média dos perfis de alumínio de 1,6mm em janela e 1,8mm em porta.*

## ACABAMENTOS

*Lacado, Lacado Decorativo (Madeira) e Anodizado.*

*Interior em Madeira: madeiras nobres (Carvalho Americano, Mogno, Pinho).*

*No acabamento destas molduras utiliza-se um verniz ecológico, sem solventes, transparente e acetinado.*

*Esta combinação de acabamentos permite uma óptima integração com a decoração interior.*

## POSSIBILIDADES DE ABERTURA

*Abertura interior: Batente, Oscilo-batente, harmónio, oscilo-paralela*

*Abertura exterior: Batente, projectante-deslizante.*

## CATEGORIAS ALCANÇADAS EM BANCO DE ENSAIOS (EN14351-1)

*Permeabilidade ao ar (EN 1026): Classe 4*

*Estanquidade à água (EN 1027): Classe 9A*

*Resistência ao vento (EN 12211): Classe C5*

*Coeficiente de transmissão térmica de vão de 2 folhas\*:  $U_w = 2.23 \text{ W/m}^2\text{K}$*

*Coeficiente de atenuação acústica de vão de 2 folhas\*:  $R_w = 35 \text{ dB}$  ( $C=-1$ ;  $C_{tr}=-4$ )*

*Zonas de aplicação segundo RCCTE (Em função de  $U_g$ ): I1,I2,I3,V1,V2,V3*

*\*Janela de 2 folhas 1,20m x 1,50m com vidro 4 /16 /6*

*( $U_g = 1,4 \text{ W/m}^2\text{K}$ ;  $g=0,57$ )*

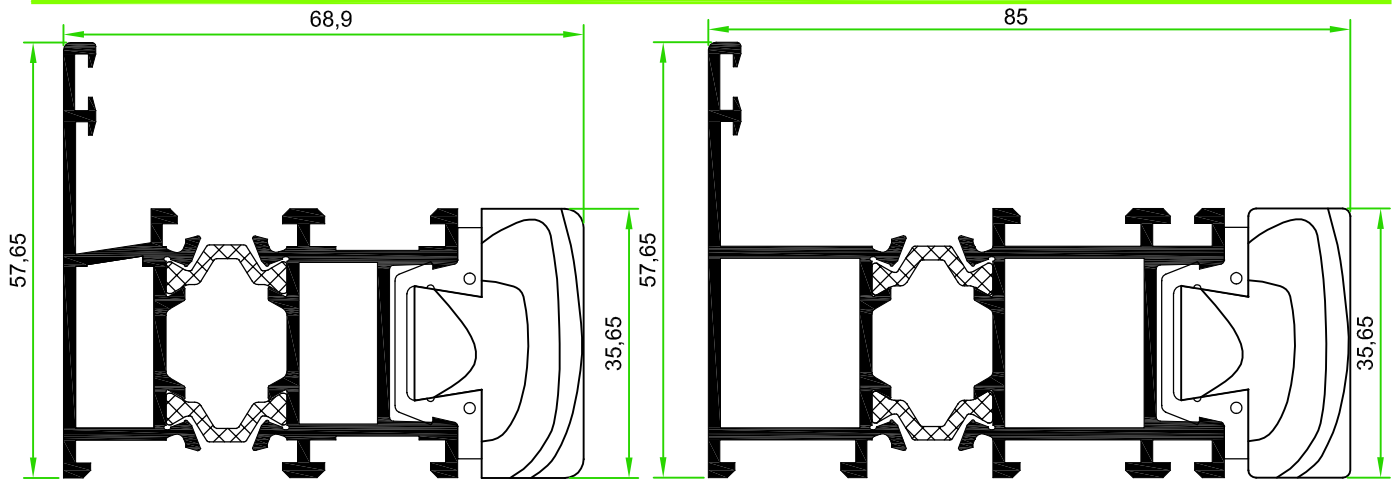

**AM-3**

*Aro fixo*

**AM-23**

*Aro para fixos abertura exterior*

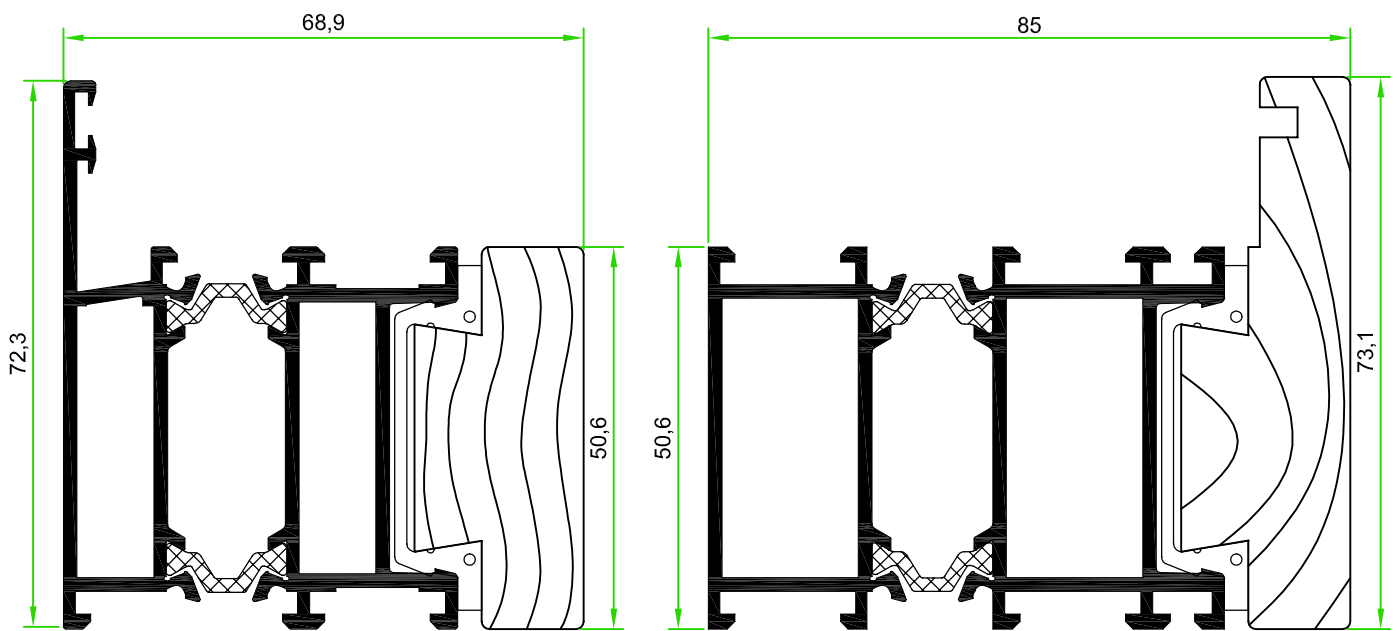

**AM-8**

*Aro fixo*

**AM-29**

*Aro fixo abertura exterior*

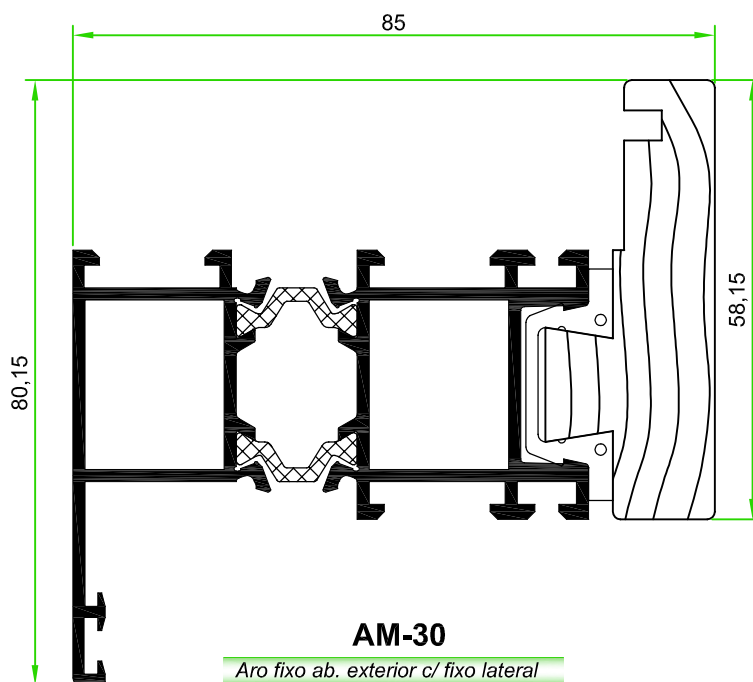

**AM-30**

*Aro fixo ab. exterior c/ fixo lateral*

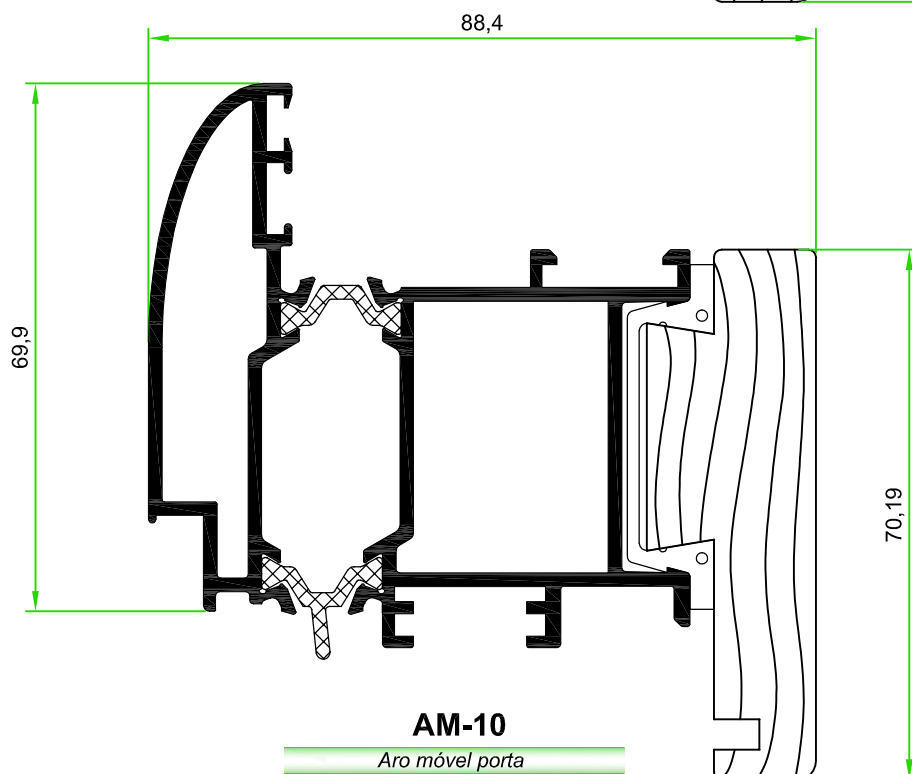
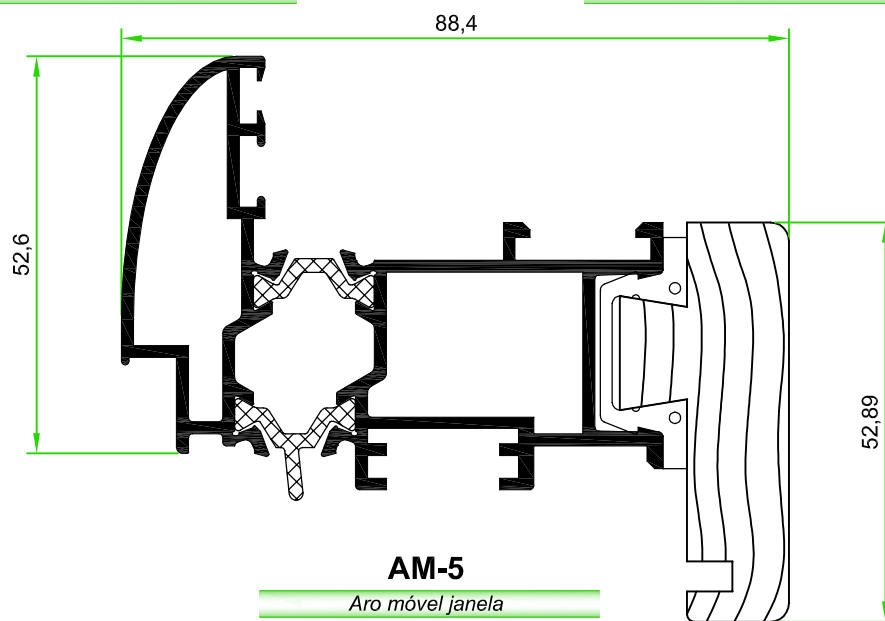
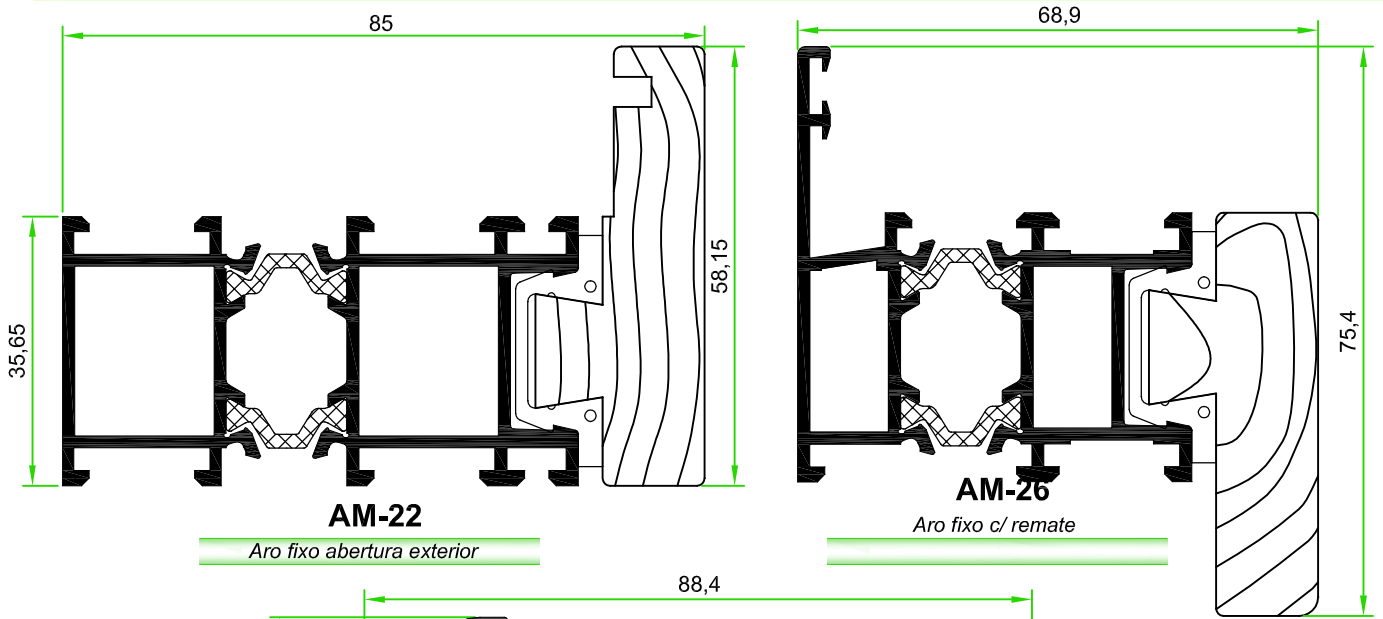

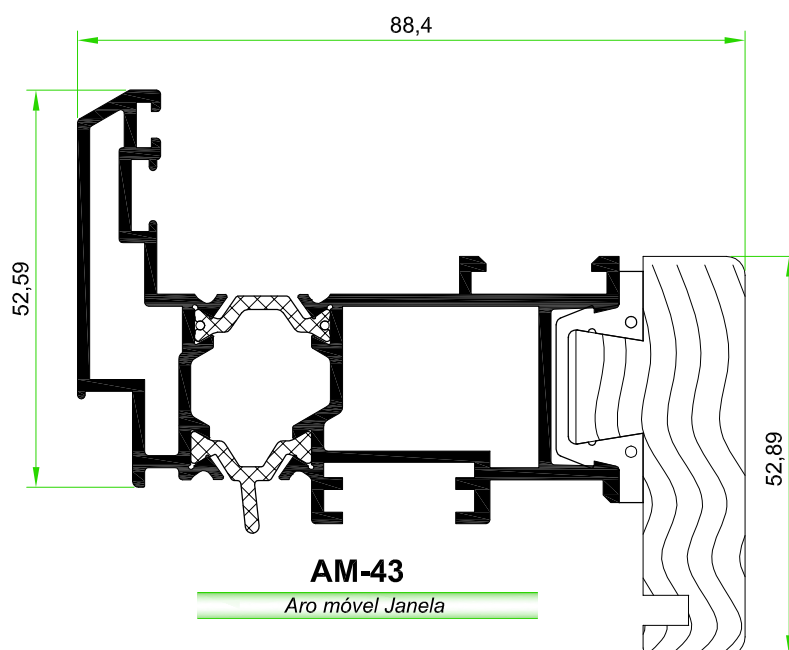
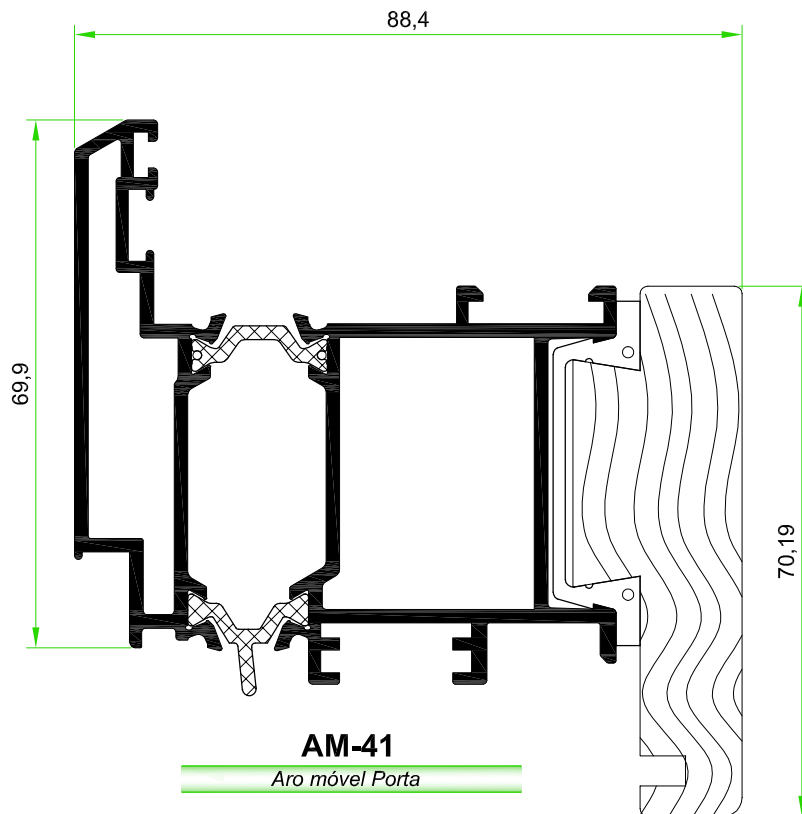

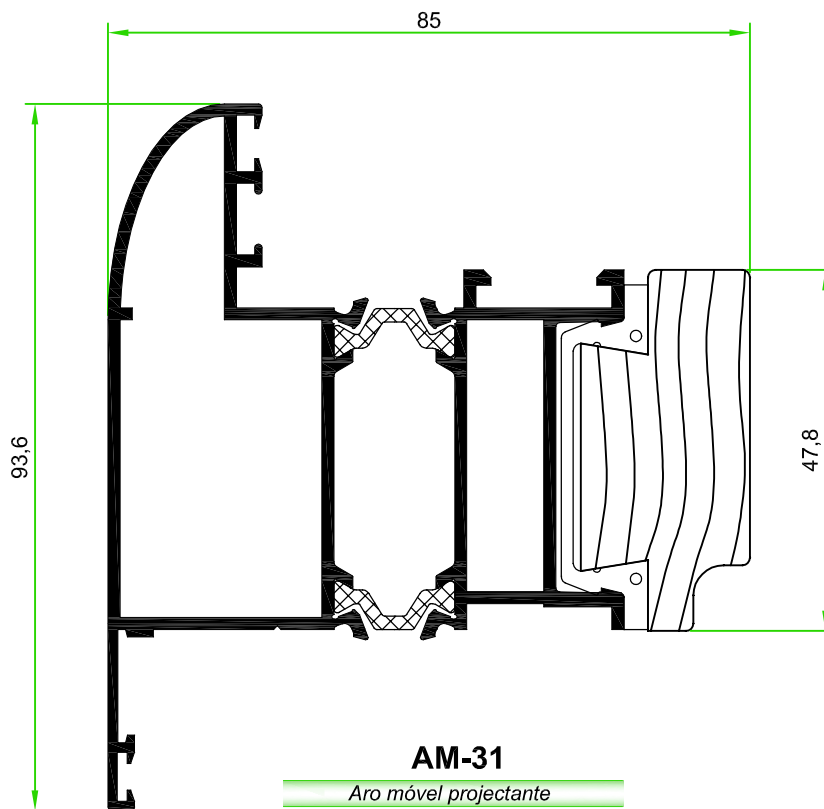
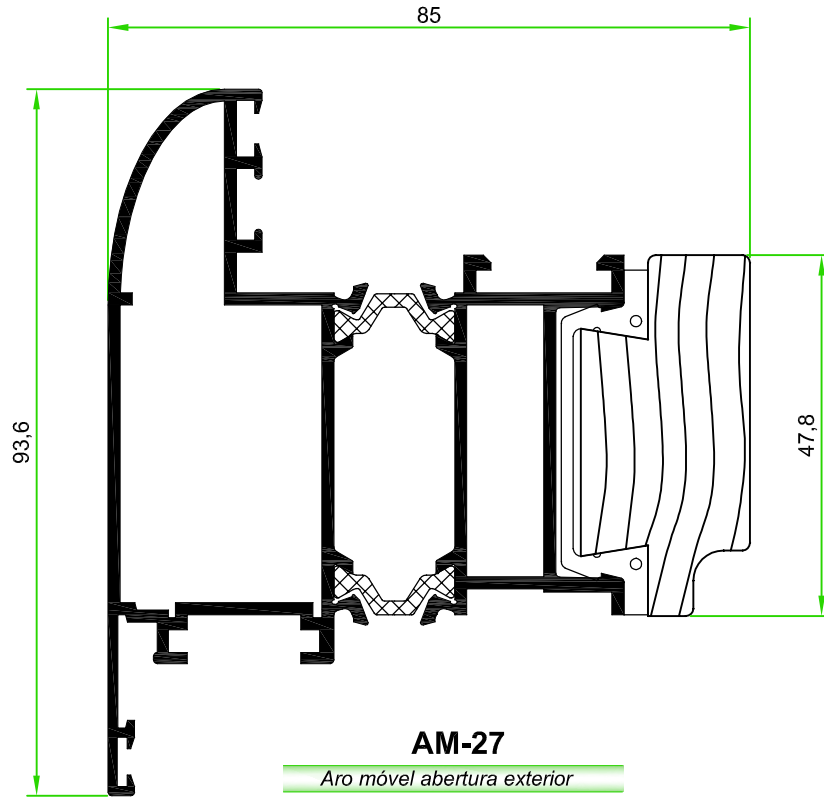

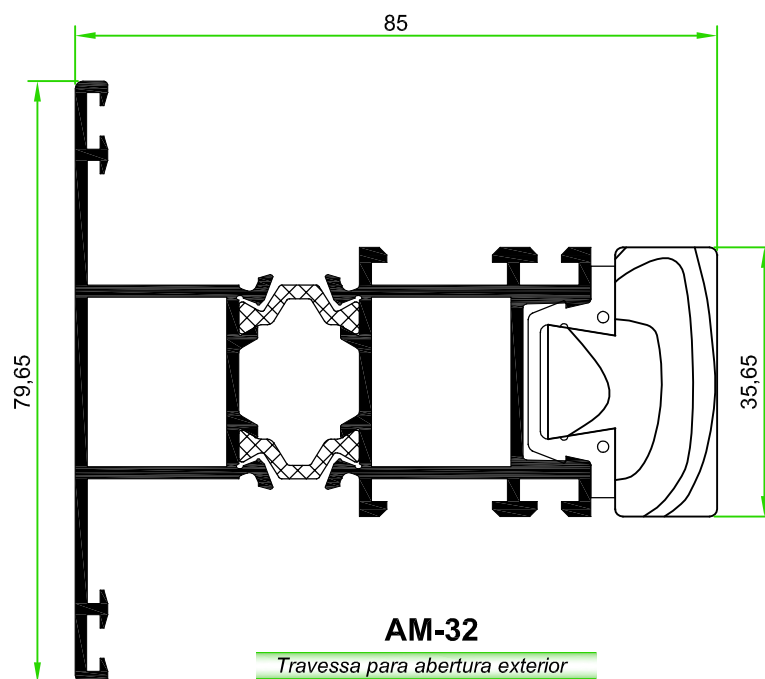
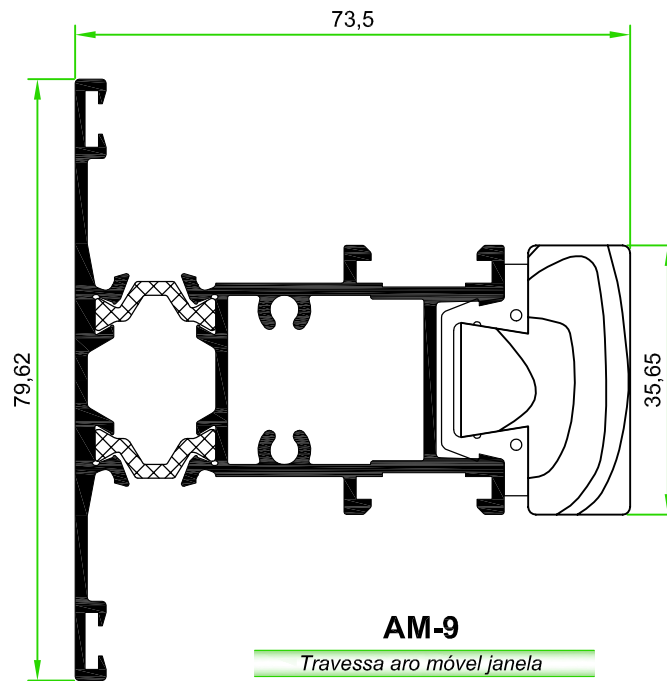
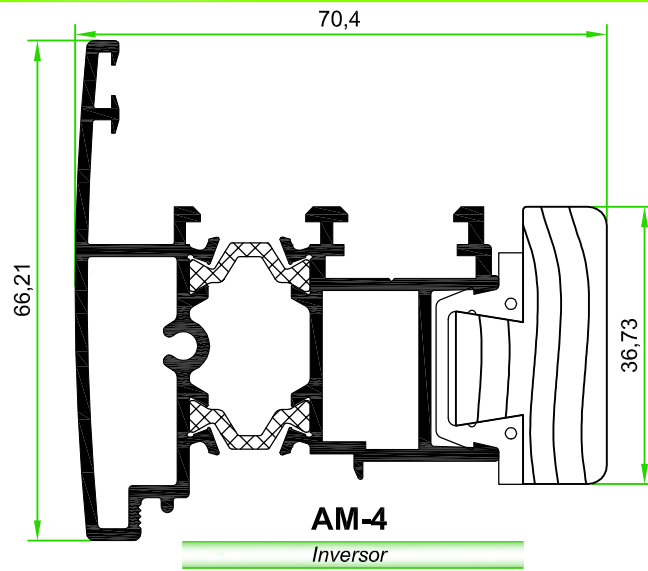

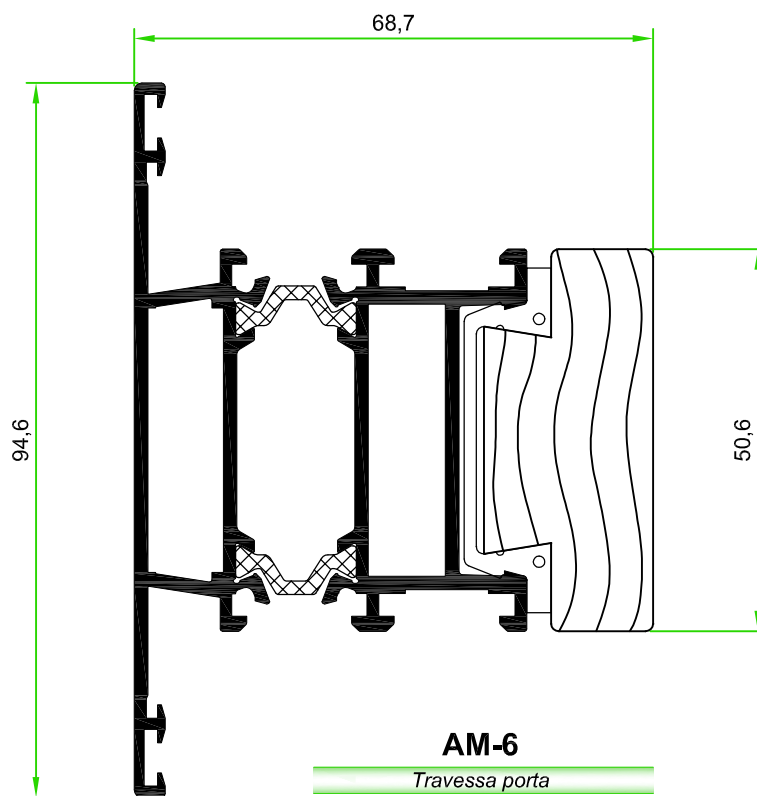
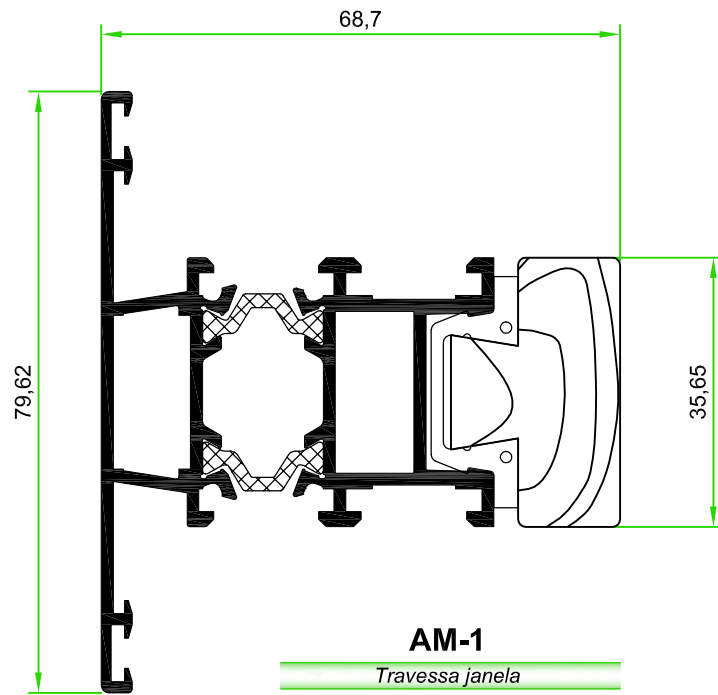



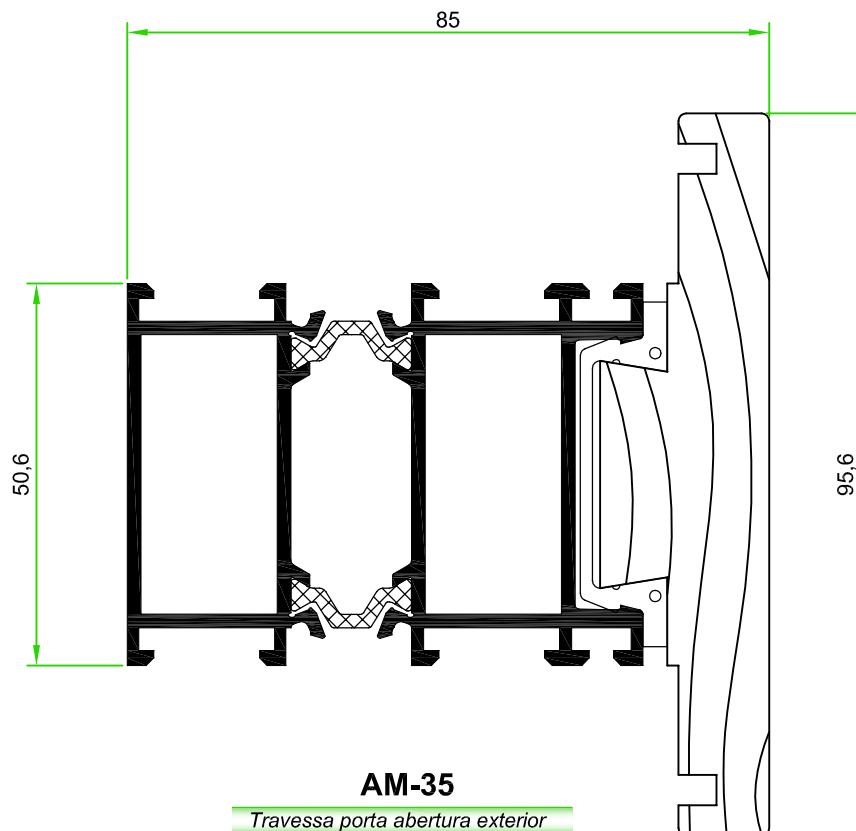
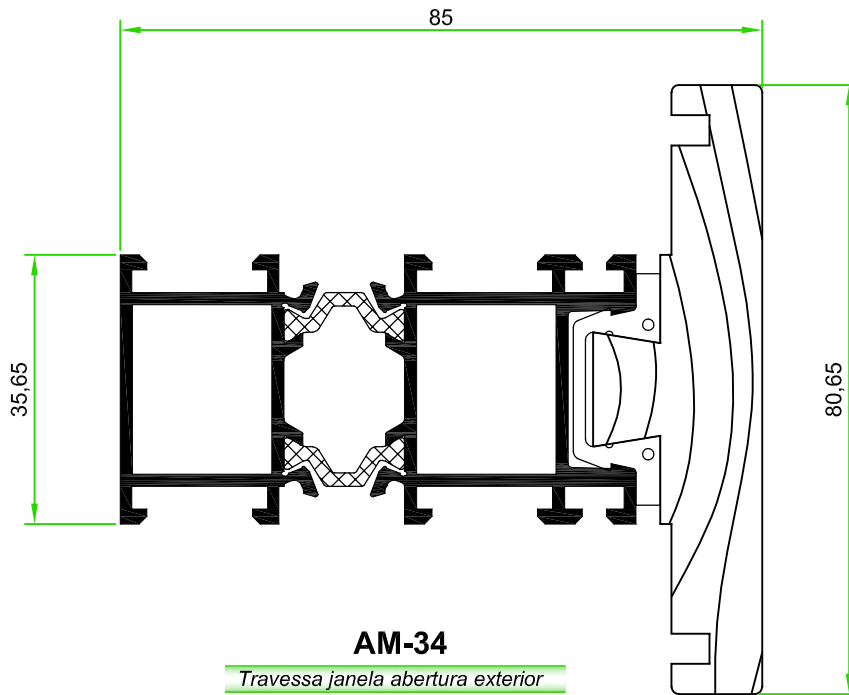

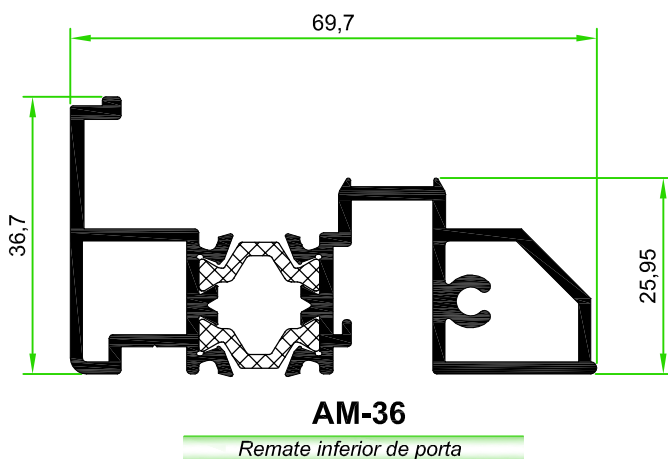
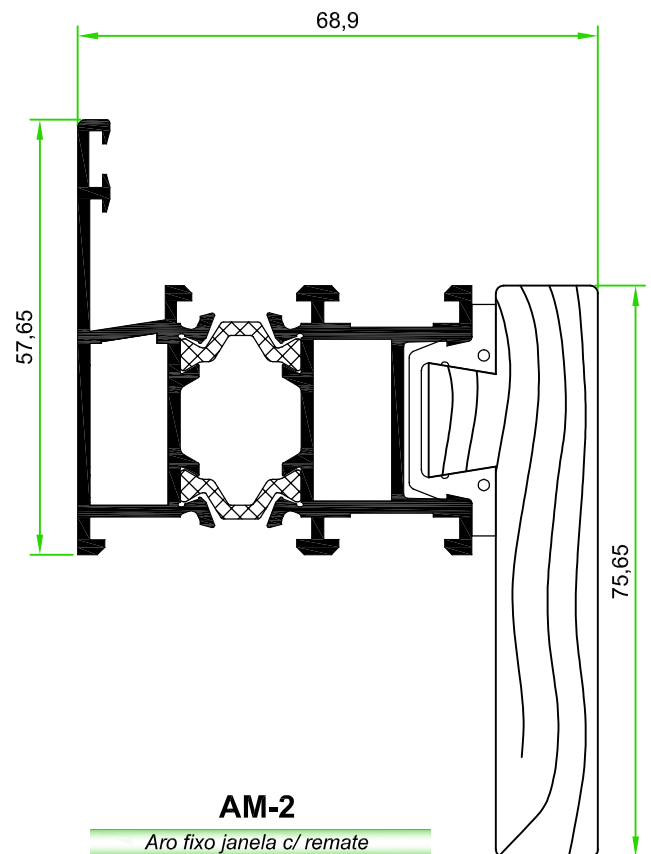
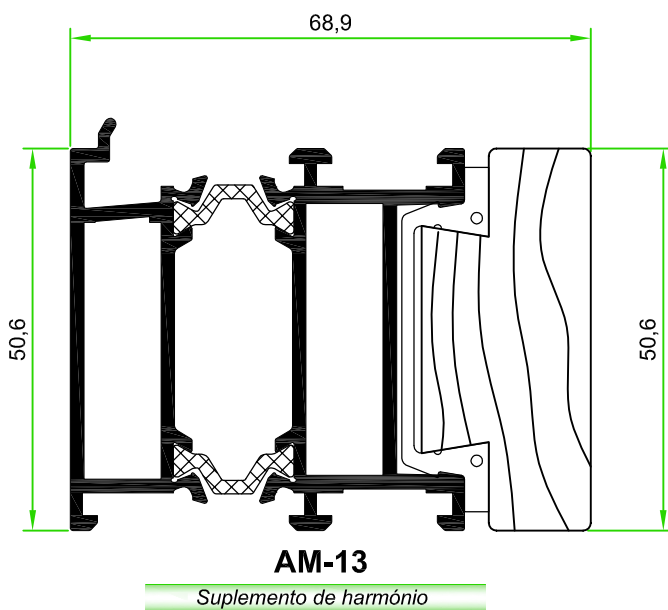
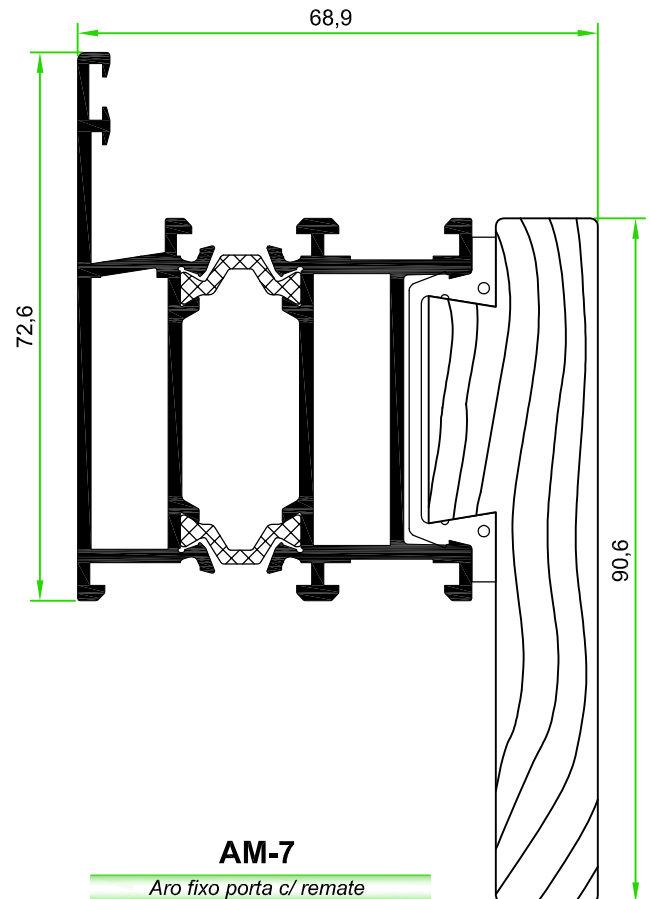
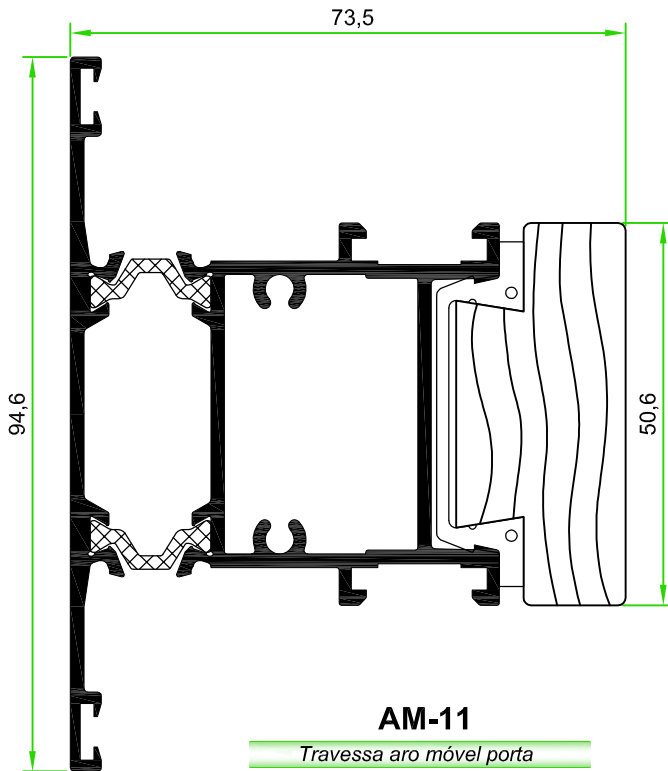

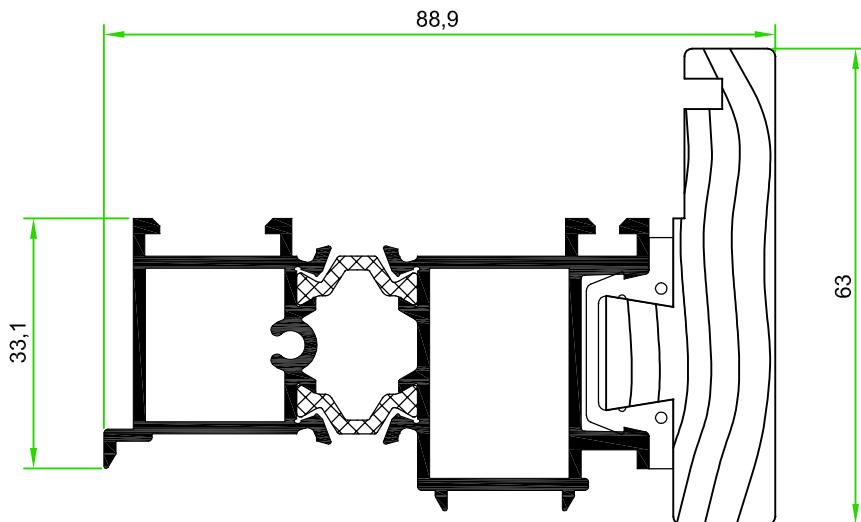

**AM-25**

*Inversor abertura exterior*

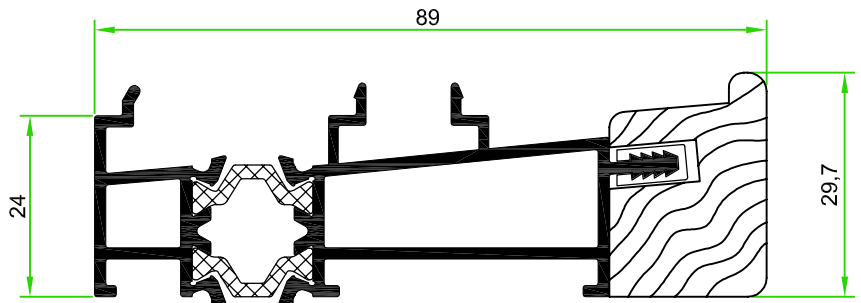

**AM-14**

*Soleira condensação*

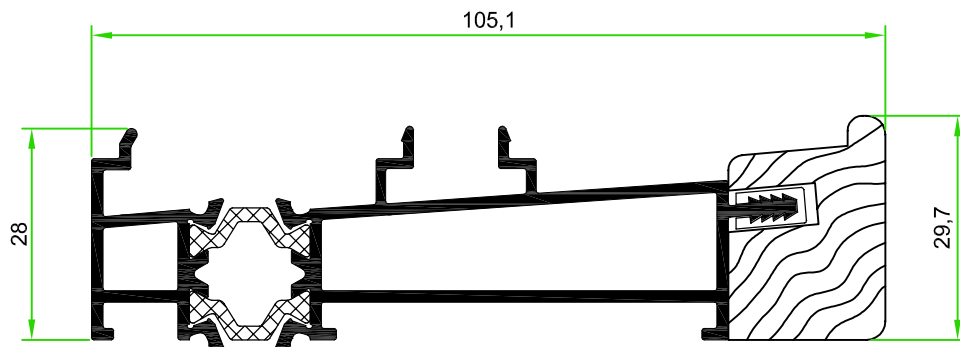

**AM-33**

*Soleira condensação ab. exterior*

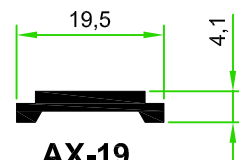

**AX-19**

*Barra cremone*

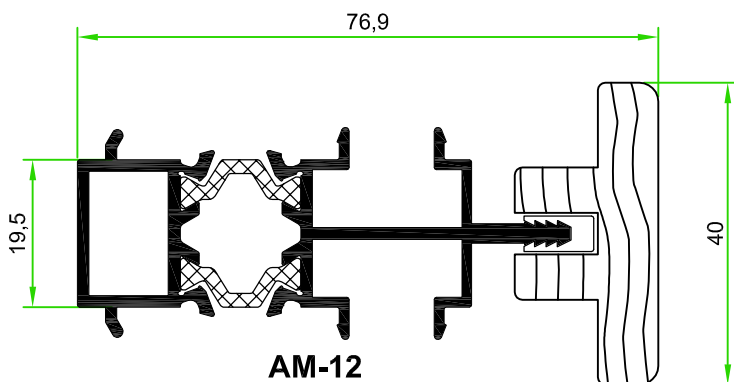

**AM-12**

*União de aros*

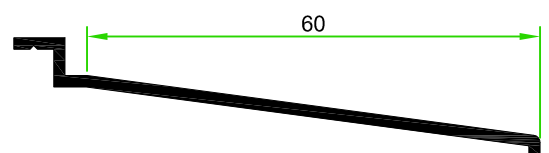

**AZ-23**

*Pingadeira 60 mm*

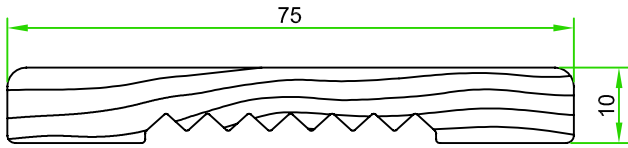

**AM-40**

Remate 75 mm

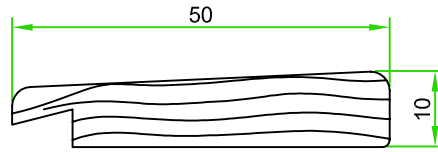

**AM-15**

Remate 50 mm

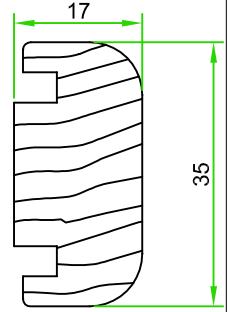

**AM-39**

Divisor de vidro

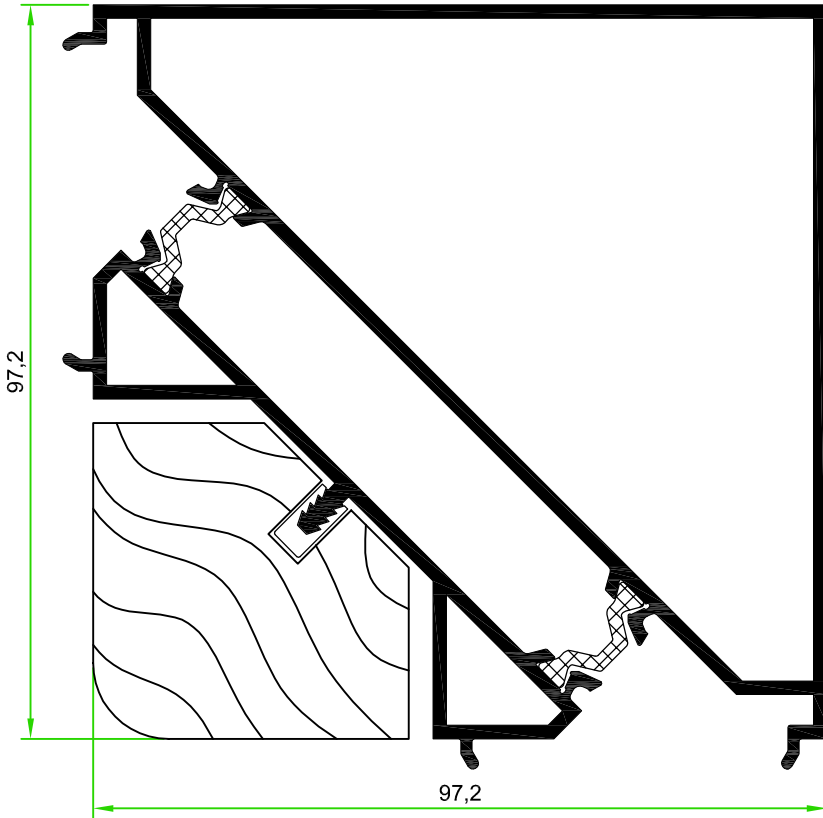

**AM-28**

Canto 90°

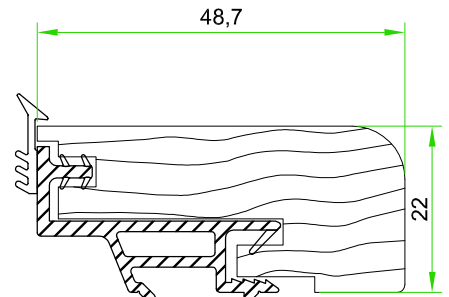

**AM-42**

Remate 50 mm

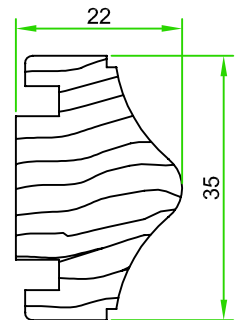

**AM-38**

Divisor de vidro tradição

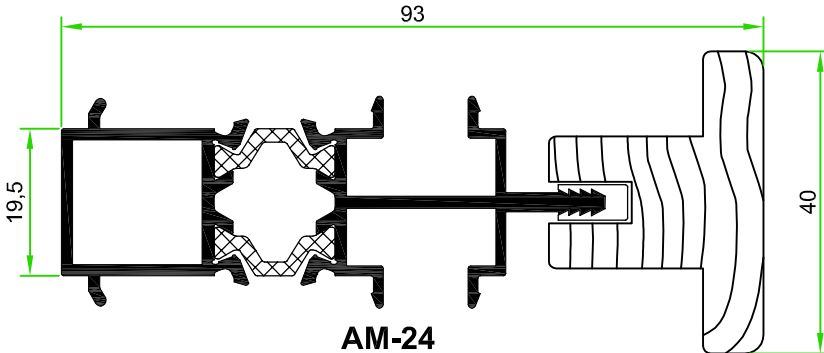

**AM-24**

União de aros abertura exterior

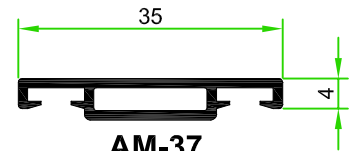

**AM-37**

Divisor de vidro

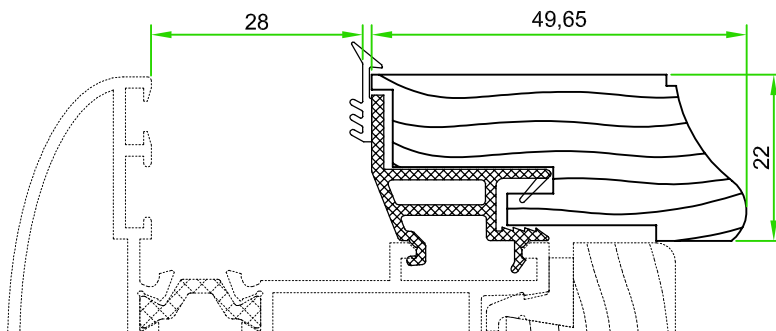

**AM-21**

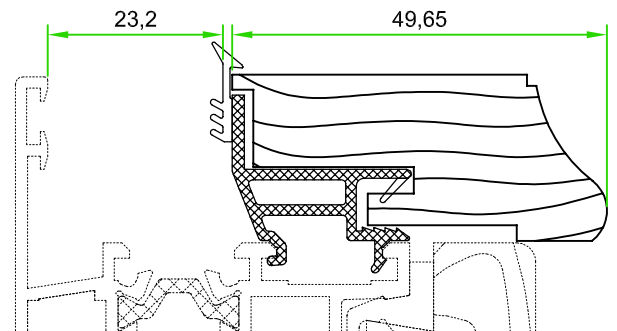

**AM-21**

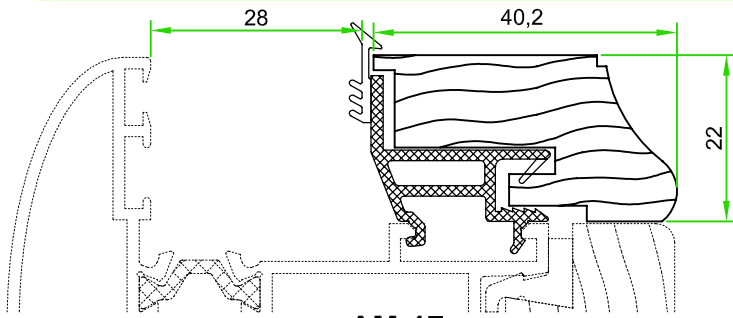

**AM-17**

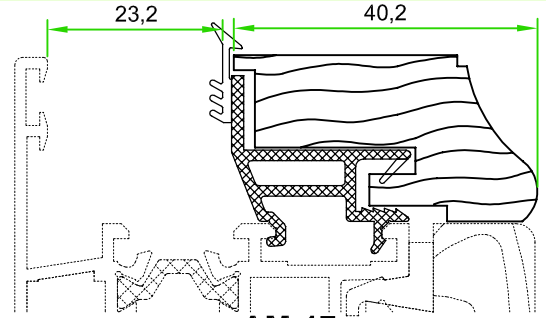

**AM-17**

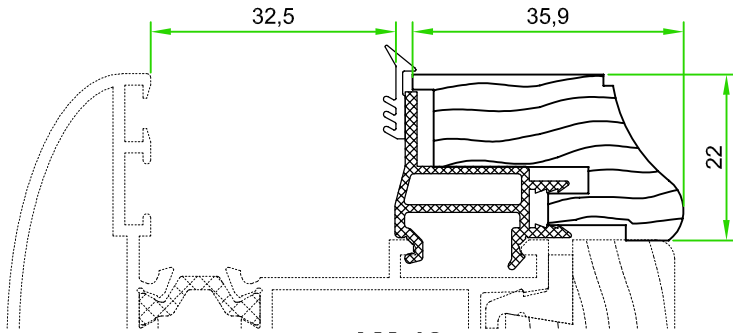

**AM-18**

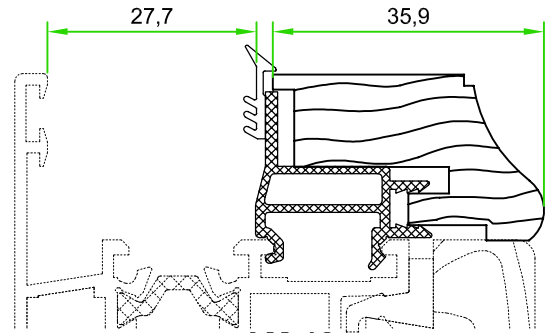

**AM-18**

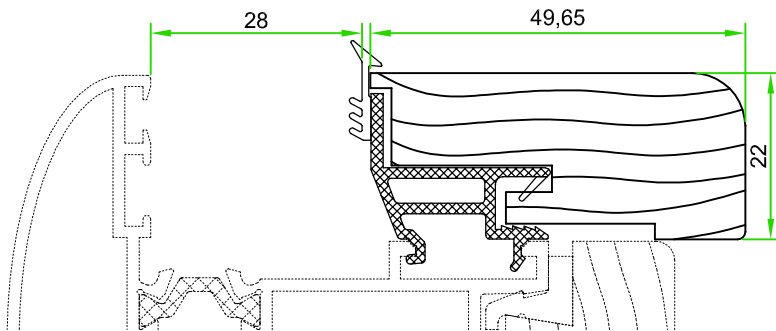

**AM-20**

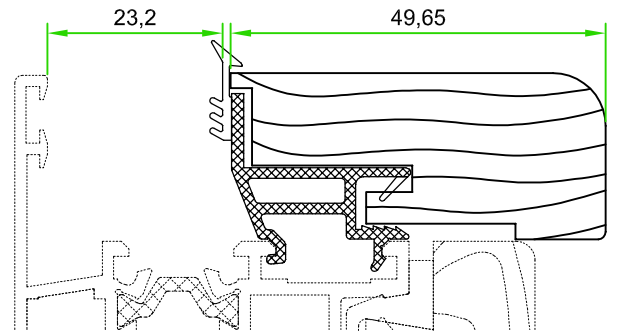

**AM-20**

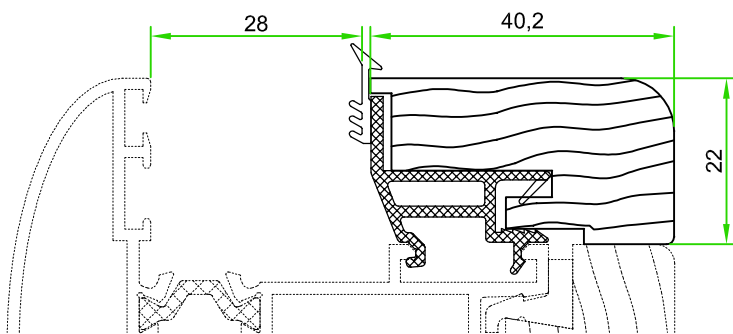

**AM-16**

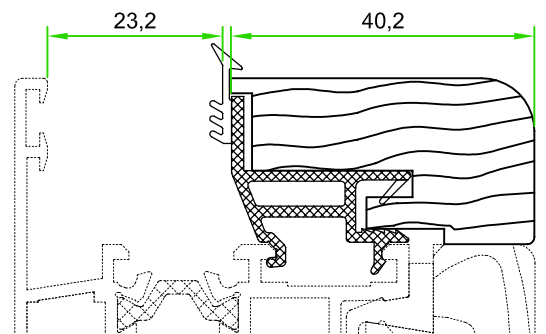

**AM-16**

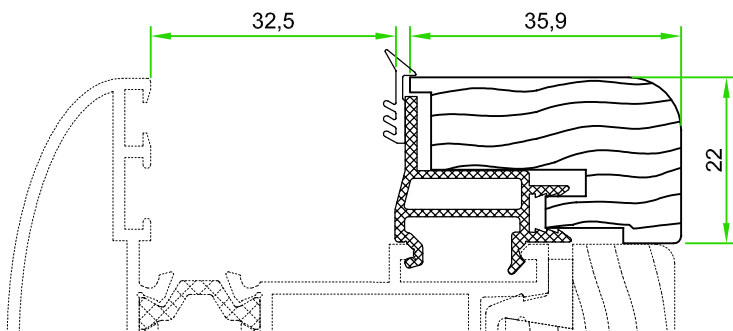

**AM-19**

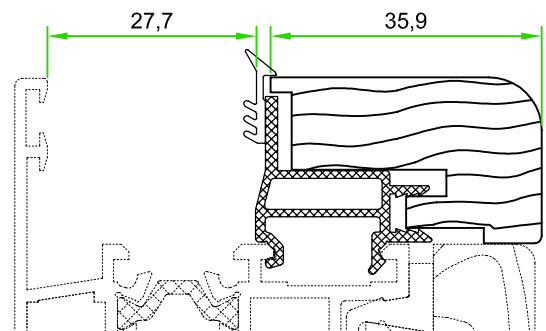

**AM-19**

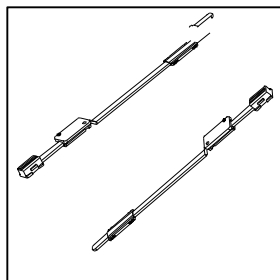
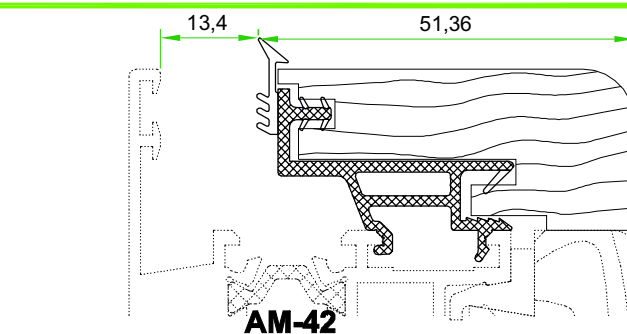
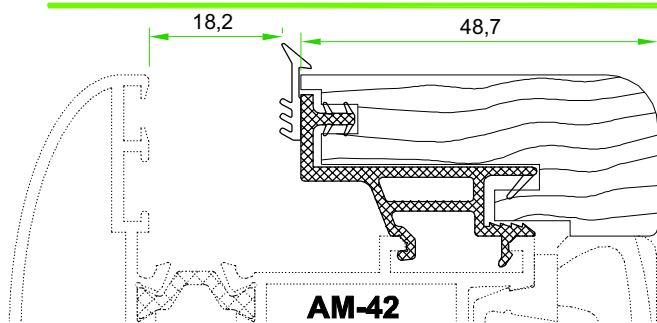

**30 21 87 04**

Jogo de fechos

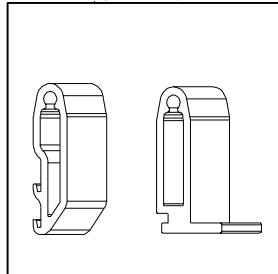

**30 21 87 05**

União topos janela int.

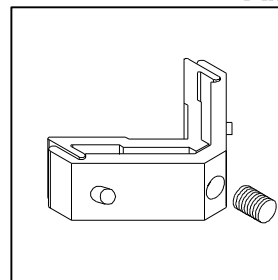

**30 21 87 07**

Esquadro aro fixo janela

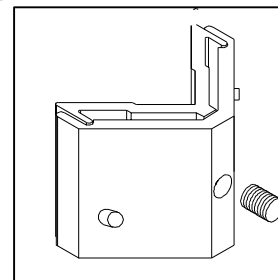

**30 21 87 08**

Esquadro aro móvel janela

**30 21 87 06**

União topos janela ext.

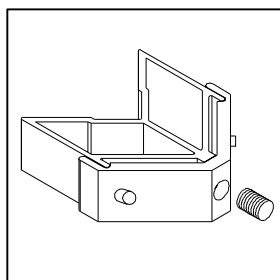

**30 21 87 09**

Esquadro aro fixo porta

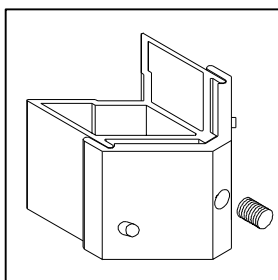

**30 21 87 10**

Esquadro aro móvel porta

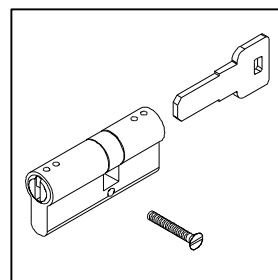

**30 21 87 11**

Canhão fechadura

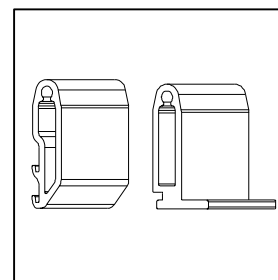

**30 21 87 12**

União topos porta int.

**30 21 87 13**

União topos porta ext.

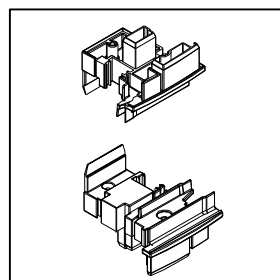

**30 21 87 15**

Jogo topos inversor

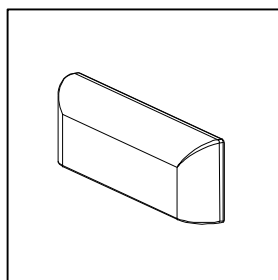

**30 92 01 00 / 30 92 01 01**

Goteiras Branco / Preto

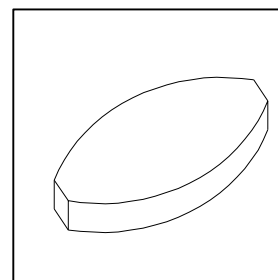

**30 95 50 40**

Pastilha alinhamento madeira

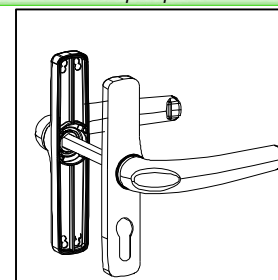

**30 95 50 90**

Jogo puxadores porta (preto)

**30 95 50 91**

Jogo puxadores porta (ouro)

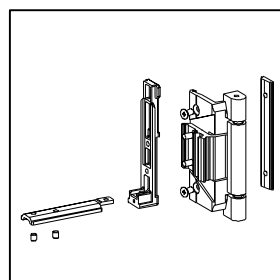

**30 95 52 10**

Dobradiça inf. 3 abas (ouro)

**30 95 52 11**

Dobradiça inf. 3 abas (preto)

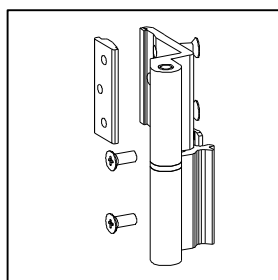

**30 95 52 12**

Dobradiça (ouro)

**30 95 52 13**

Dobradiça (preto)

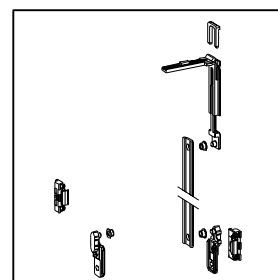

**30 95 52 14**

Kit fecho 6 pontos

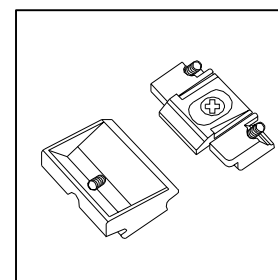

**30 95 52 15**

Fecho suplem. lado dobradiças



**30 95 52 16**

*Kit 1 folha (ouro)*

**30 95 52 17**

*Kit 1 folha (preto)*

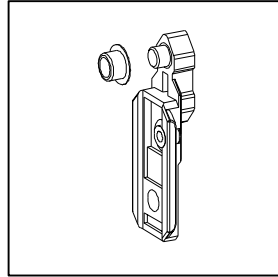

**30 95 52 22**

*Fecho*

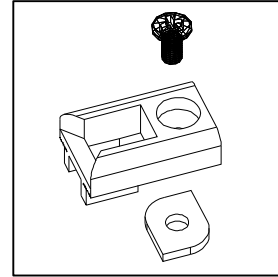

**30 95 52 23**

*Sistema de fecho simples*

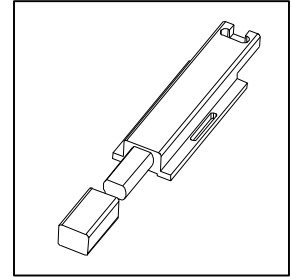

**30 95 52 26**

*Terminal barra nylon*

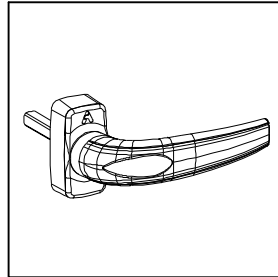

**30 95 52 20**

*Puxador simples (ouro)*

**30 95 52 21**

*Puxador simples (preto)*

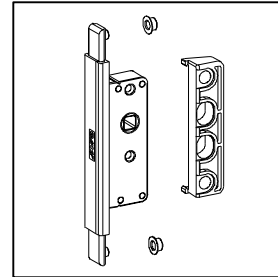

**30 95 52 24**

*Transmissão simples*

**30 95 52 25**

*Transmissão dupla*

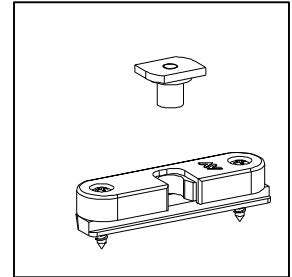

**30 95 52 27**

*Clip com parafusos inox*

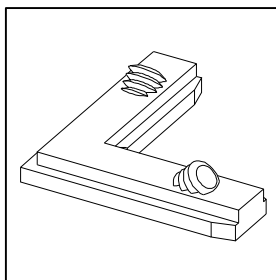

**30 96 00 15**

*Esquadro alinhamento*

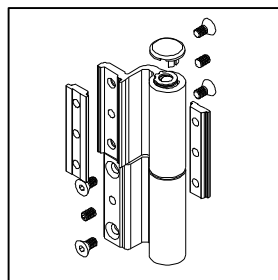

**30 23 20 13**

*Dobradiça porta ab. ext. direita*

**30 23 20 33**

*Dobradiça porta ab. ext. esquerda*

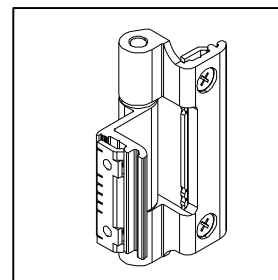

**30 23 30 13**

*Dobradiça janela ab. ext. direita*

**30 23 30 33**

*Dobradiça janela ab. ext. esquerda*

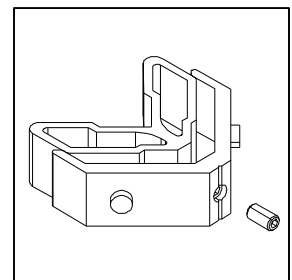

**30 24 87 28**

*Esquadro aro fixo janela ab. ext.*

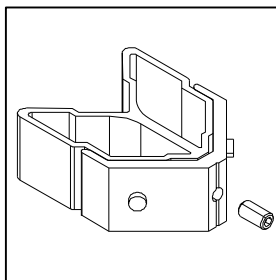

**30 24 87 37**

*Esquadro ext. aro móvel ab. ext.*

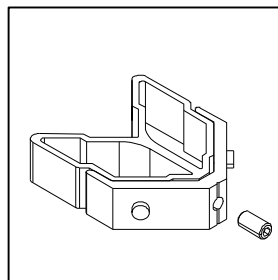

**30 24 87 48**

*Esquadro aro fixo porta ab. ext.*

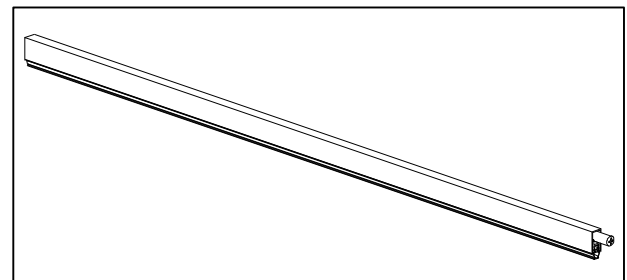

**30 24 87 05**

*Cortaventos 500 mm*

**30 24 87 07**

*Cortaventos 700 mm*

**30 24 87 09**

*Cortaventos 900 mm*

**30 24 87 11**

*Cortaventos 1100 mm*

**30 24 87 06**

*Cortaventos 600 mm*

**30 24 87 08**

*Cortaventos 800 mm*

**30 24 87 10**

*Cortaventos 1000 mm*

**30 24 87 12**

*Cortaventos 1200 mm*

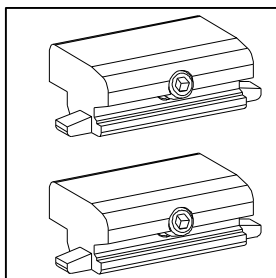

**30 25 87 42**

*Jogo topos activação cortaventos*

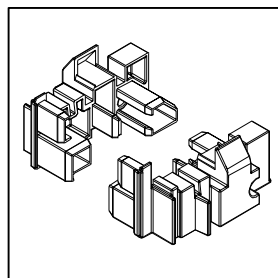

**30 25 87 70**

*Jogo topos remate inferior*



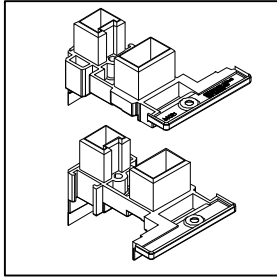

**30 24 87 15**

*Jogo topos inv. ab. ext. carvalho/pinho*

**30 24 87 25**

*Jogo topos inv. ab. ext. mogno*

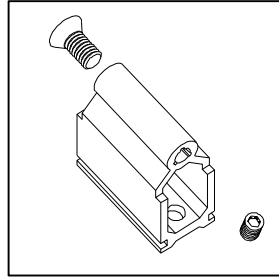

**30 24 87 50**

*Topo travessa porta ab. ext.*

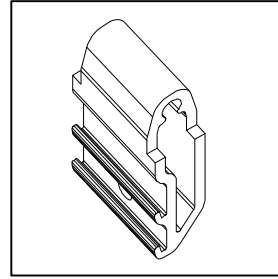

**30 24 87 46**

*Topo travessa ab. ext.*

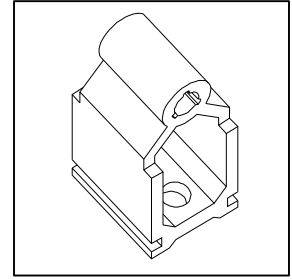

**30 24 87 40**

*Topo travessa janela ab. ext.*

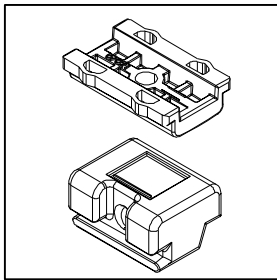

**30 24 30 76**

*Apoio de folha ab. ext.*

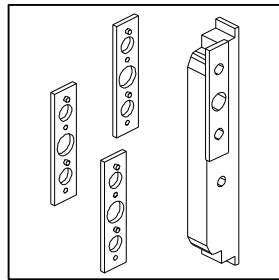

**30 90 20 41**

*Transmissão ab. ext.*

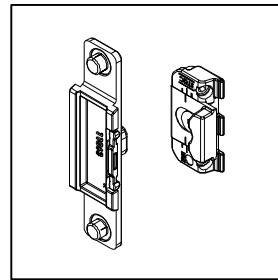

**30 25 30 66**

*Ponto fecho intermédio ab. ext.*

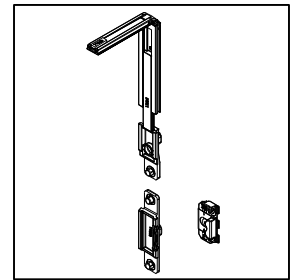

**30 25 30 63**

*Ponto fecho suplementar ab. ext.*

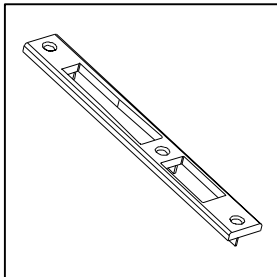

**30 92 05 20**

*Chapa-testa central*

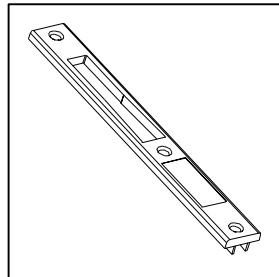

**30 92 05 30**

*Chapa-testa extremos*

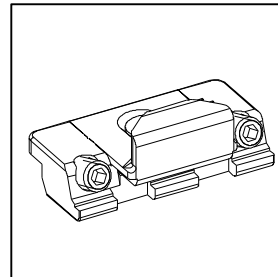

**30 24 87 10**

*Complemento fecho*

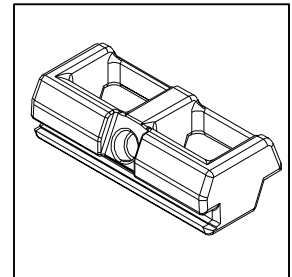

**30 24 30 84**

*Complemento fecho 1 folha ab. ext.*

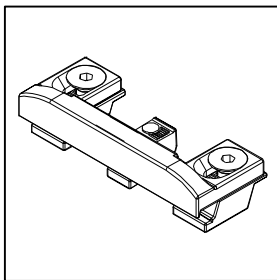

**30 24 30 74**

*Complemento fecho 2 folhas ab. ext.*

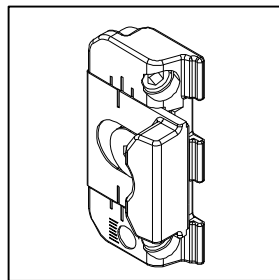

**30 25 30 64**

*Complemento fecho suplementar*

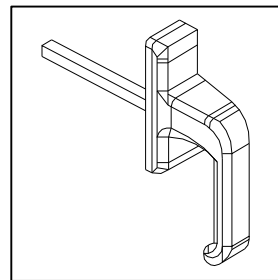

**30 95 50 00**

*Cremone ab. ext.*

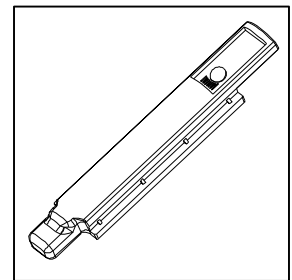

**30 24 30 73**

*Terminal de fecho ab. ext.*

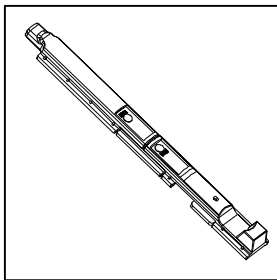

**30 24 30 77**

*Fecho 2ª folha ab. ext.*

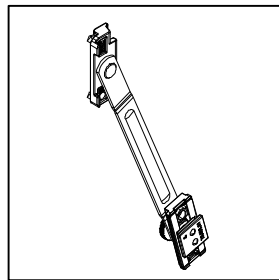

**30 92 04 75**

*Jogo compasso basculante*

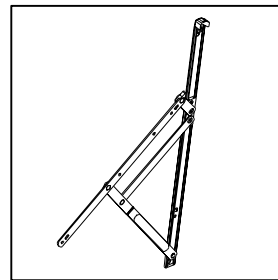

**30 92 04 90**

*Compasso projectante-deslizante*

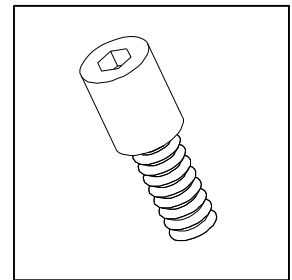

**30 25 10 22**

*Parafuso transmissão ab. ext. 22 mm*



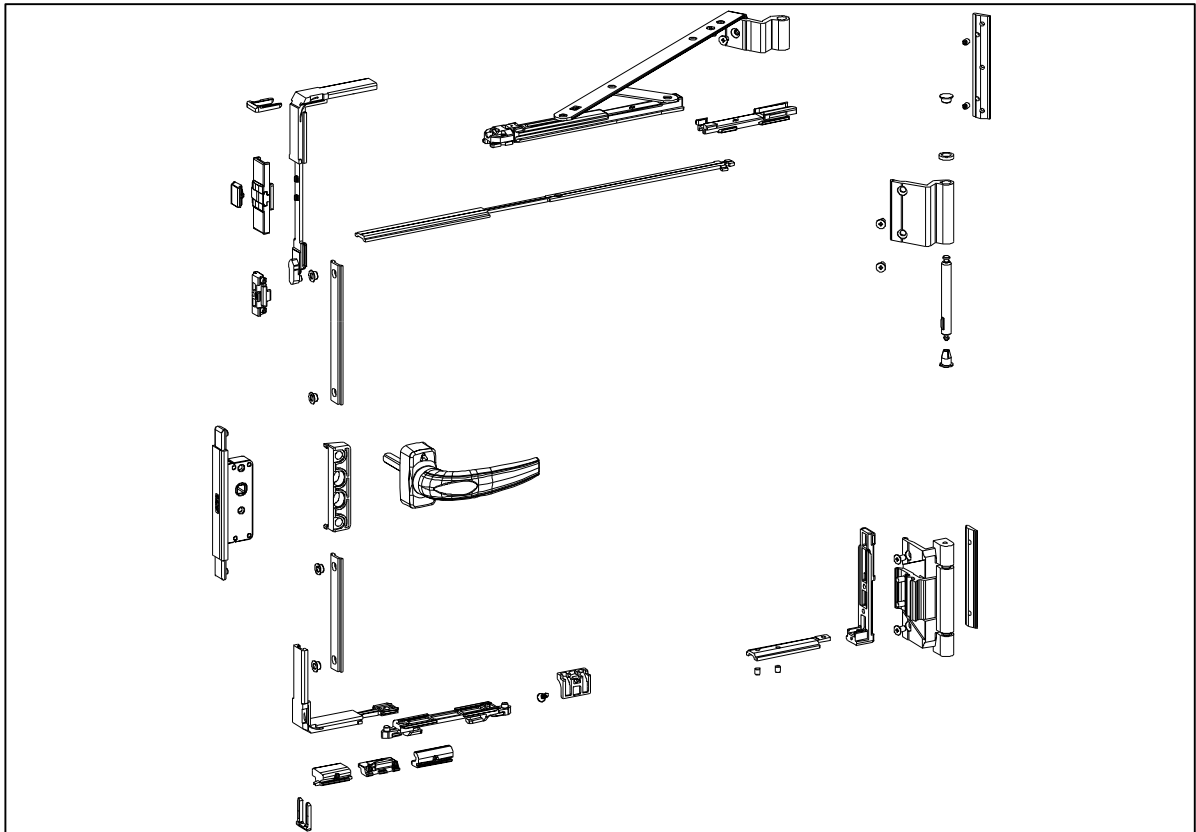

**30 95 52 00**

*Kit oscilo-batente standard 1 folha (ouro)*

**30 95 52 01**

*Kit oscilo-batente standard 1 folha (preto)*

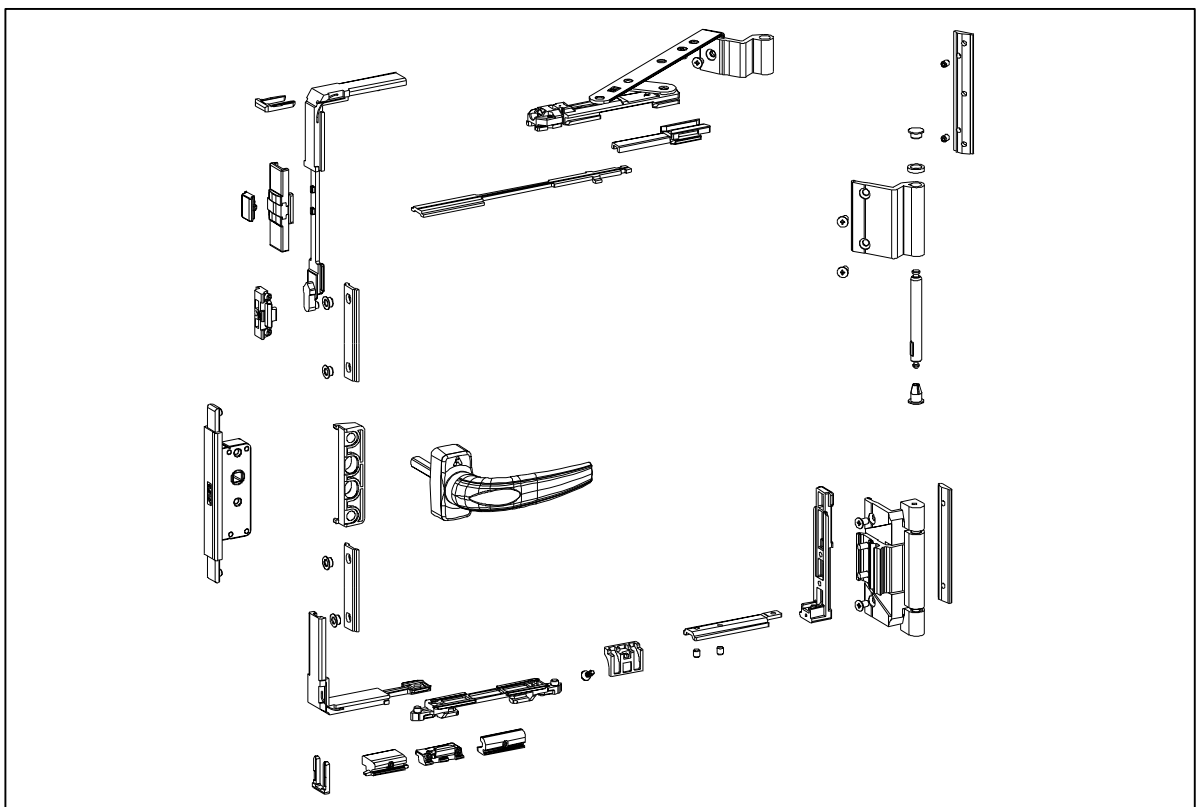

**30 95 52 02**

*Kit oscilo-batente compasso pequeno 1 folha (ouro)*

**30 95 52 03**

*Kit oscilo-batente compasso pequeno 1 folha (preto)*

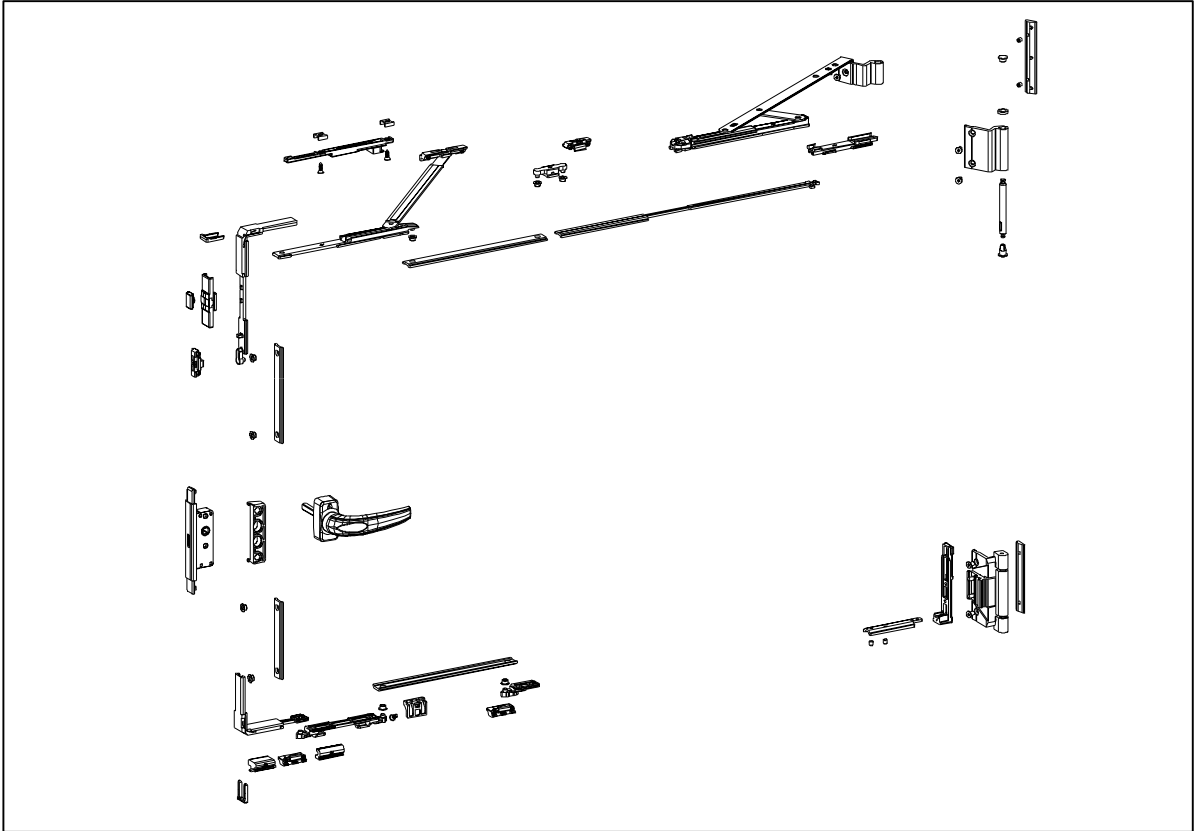

**30 95 52 04**

*Kit oscilo-batente standard + suplemento 1 folha (ouro)*

**30 95 52 05**

*Kit oscilo-batente standard + suplemento 1 folha (preto)*

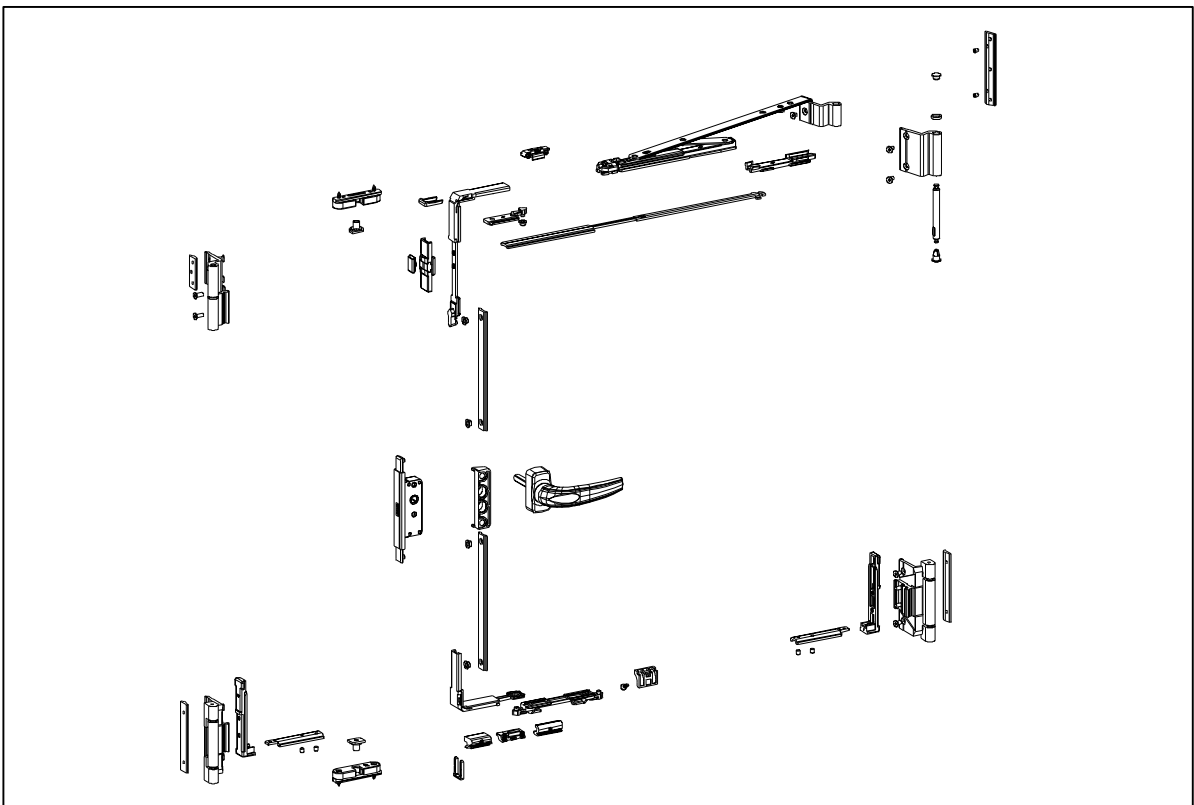

**30 95 52 06**

*Kit oscilo-batente 2 folhas compasso standard (ouro)*

**30 95 52 07**

*Kit oscilo-batente 2 folhas compasso standard (preto)*

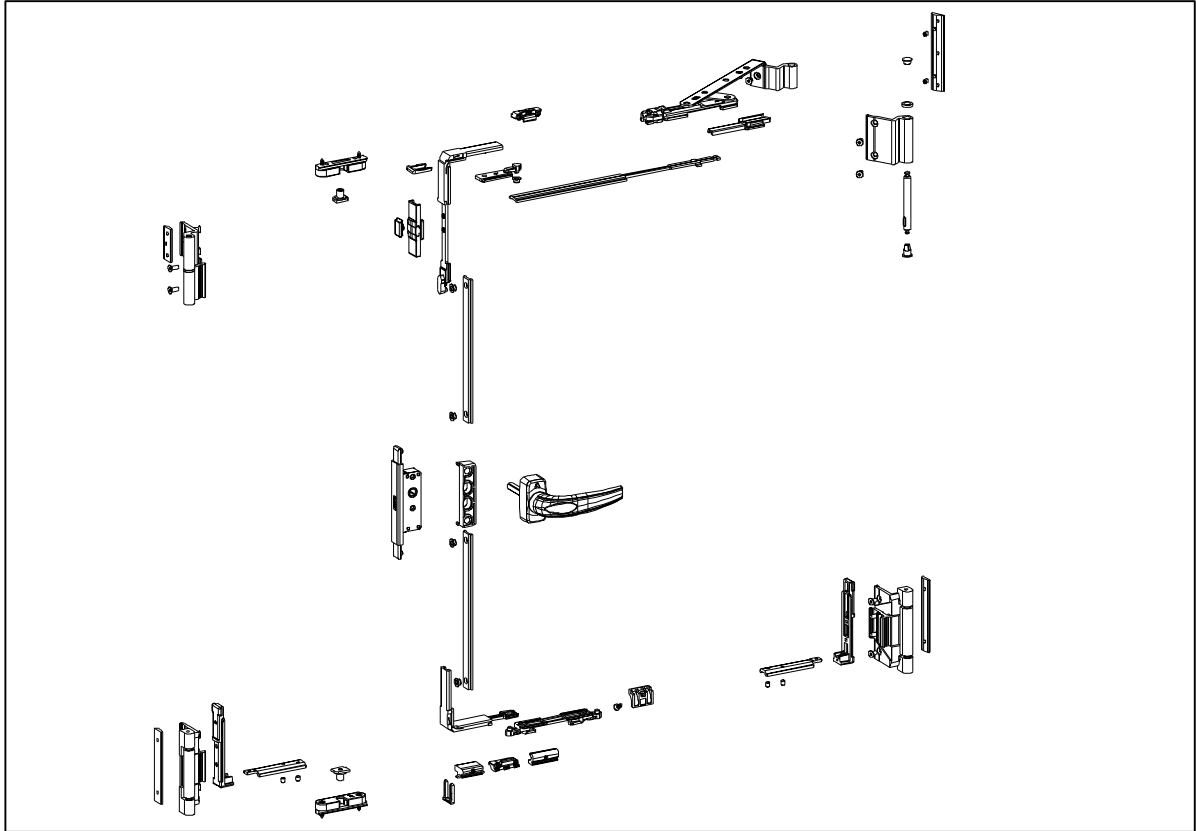

**30 95 52 08**

*Kit oscilo-batente compasso pequeno 2 folhas (ouro)*

**30 95 52 09**

*Kit oscilo-batente compasso pequeno 2 folhas (preto)*

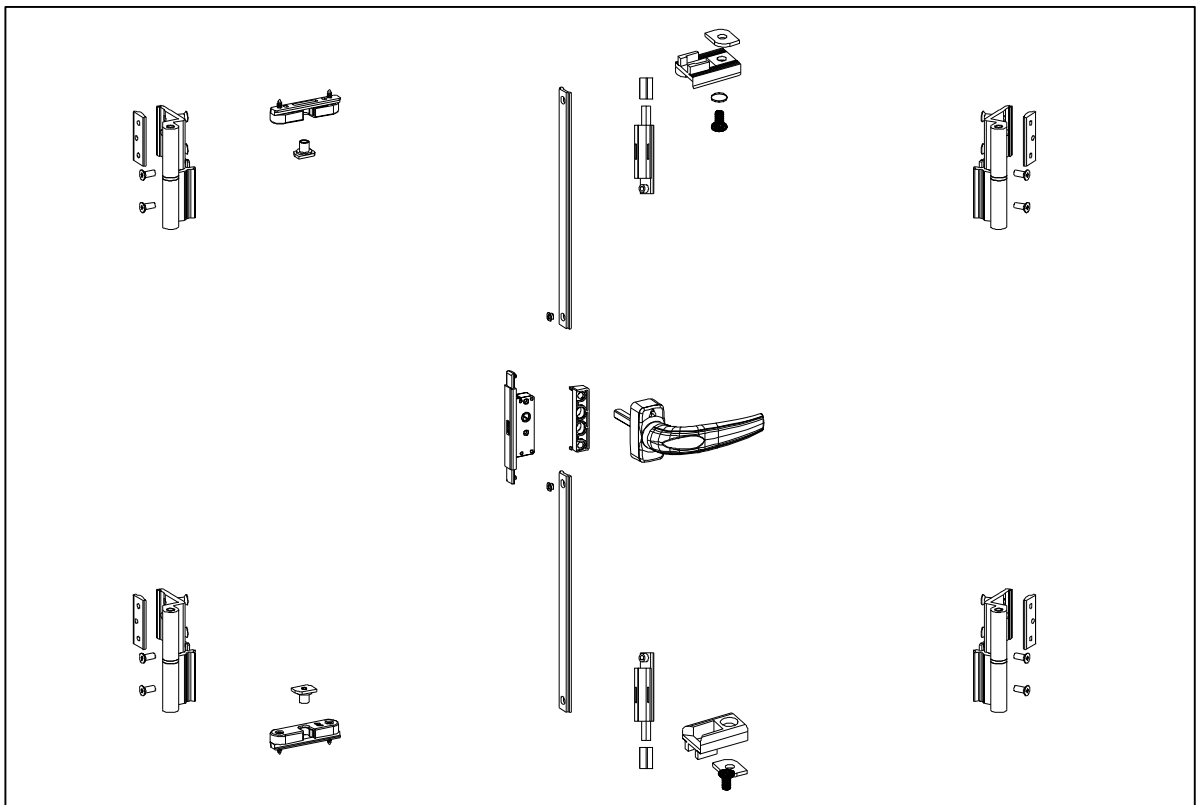

**30 95 52 18**





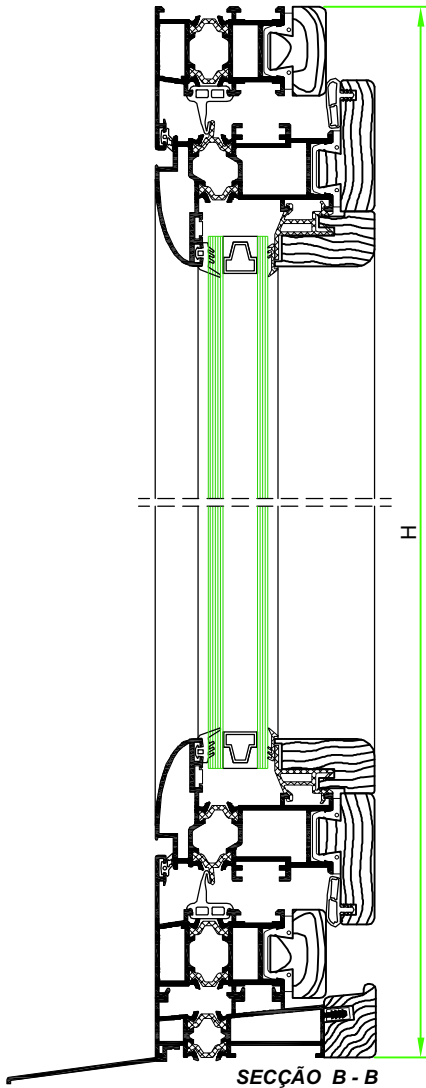
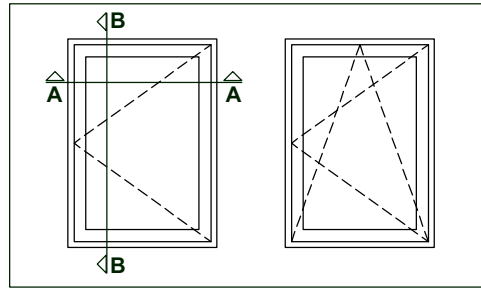

*Kit abrir 2 folhas (ouro)*

**30 95 52 19**

*Kit abrir 2 folhas (preto)*

<b>REFERÊNCIA</b>	<b>DESENHO</b>	<b>DESCRIÇÃO</b>
30 21 87 01		Junta interior
30 93 00 90		Junta exterior
30 21 87 03		Junta central
30 23 87 01		Junta divisor de vidro posição
30 24 87 01		Junta interior para ab. exterior
30 24 87 02		Junta exterior com fio anti-encolhimento
30 93 00 60		Junta vidro exterior (Opcional)
30 93 01 30		Junta exterior para ab. exterior





**JANELA 1 FOLHA DE ABRIR E OSCILO-BATENTE**

**PERFIS**

Des.	Ref.	Descrição	Corte	Quant.	Medida
	AM-3	Aro fixo		2	L
	AM-5	Aro móvel		2	H-24
	AM-16	Bite		2	L-61
	AX-19	Barra cremone		2	H-85
	AM-14	Condensação		2	L-167
	AZ-23	Pingadeira		2	H-191
	AX-19	Barra cremone		2	Aprox. H/2
	AM-14	Condensação		1	L
	AZ-23	Pingadeira		1	L

**ACESSÓRIOS**

Ref.	Descrição	Quant.	
		Abrir	Osc.Bat.
30 21 87 07	Esquadro aro janela	8	8
30 21 87 08	Esquadro móvel janela	4	4
30 92 01 00	Goteiras	2	2
30 95 50 40	Pastilha de alinhamento madeira	8	8
30 95 52 00	Kit. OB 1F Ouro	---	1
30 95 52 16	Kit abrir 1F Ouro	1	---
30 96 00 15	Esquadro alinhamento	4	4

**VEDANTES**







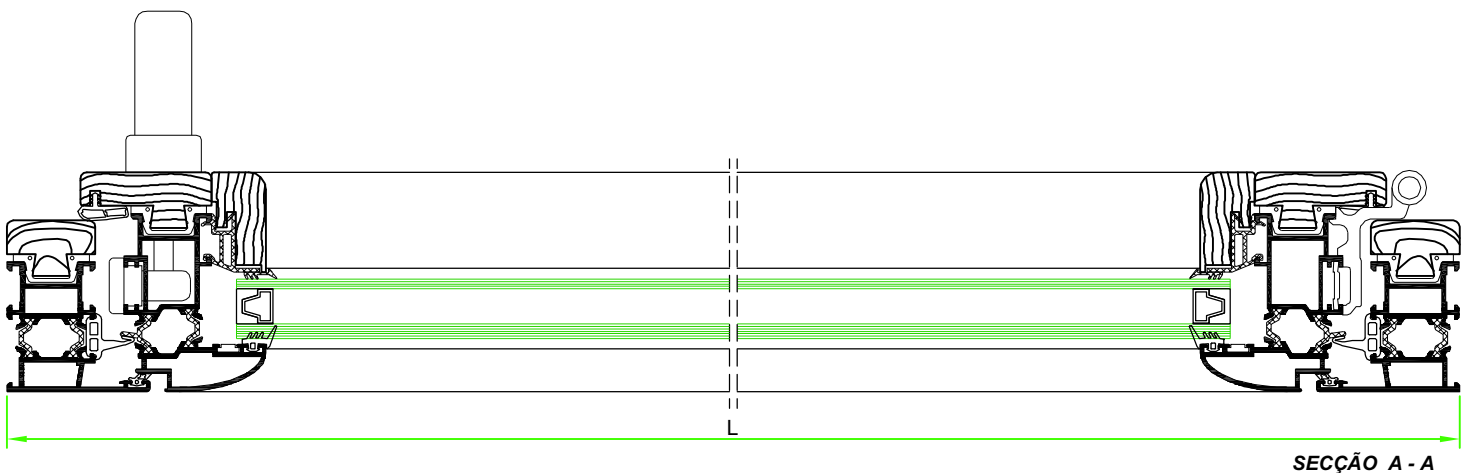

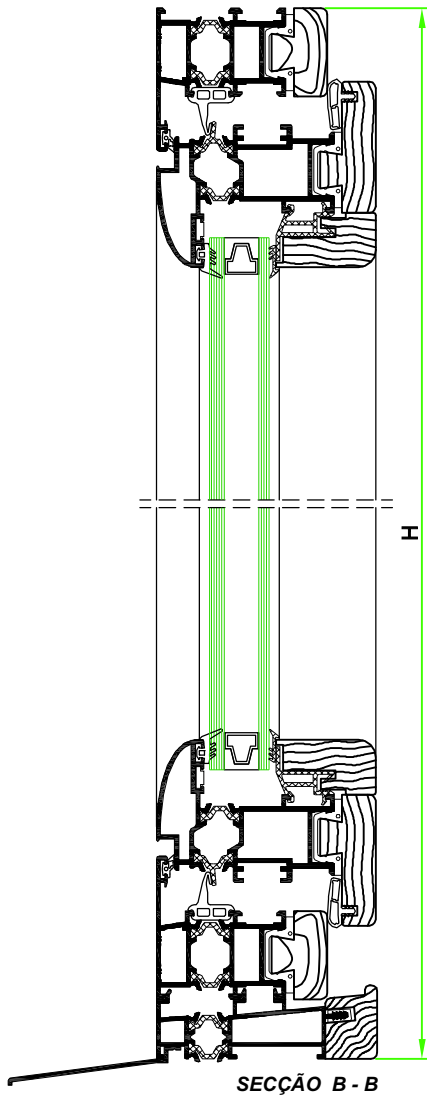
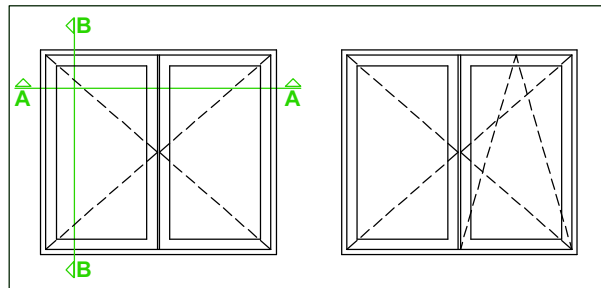



Des.	Ref.	Descrição	Quant.	Medida
	30 21 87 01	Junta interior	2	L
	30 21 87 02	Junta exterior	2	H
	30 21 87 03	Junta central	2	L
	30 21 87 03	Junta central	2	H

**VIDRO**

L-187	H-211
-------	-------





**JANELA 2 FOLHAS DE ABRIR E OSCILO-BATENTE**

**PERFIS**

Des.	Ref.	Descrição	Corte	Quant.	Medida
	AM-3	Aro fixo		2	L H-24
	AM-5	Aro móvel		4 4	L/2-35 H-85
	AM-4	Inversor		1	H-157
	AM-16	Bite		4 4	L/2-143 H-191
	AX-19	Barra cremone		2	Aprox. H/2
	AM-14	Condensação		1	L
	AZ-23	Pingadeira		1	L

**ACESSÓRIOS**

Ref.	Descrição	Quant.	
		Abrir	Osc.Bat.
30 21 87 07	Esquadro aro janela	8	8
30 21 87 08	Esquadro móvel janela	8	8
30 21 87 15	Jogo topos inversor	1	1
30 92 01 00	Goteiras	2	2
30 95 50 40	Pastilha de alinhamento madeira	12	12
30 95 52 06	Kit. OB 2F Ouro	---	1
30 95 52 18	Kit abrir 2F Ouro	1	---
30 96 00 15	Esquadro alinhamento	8	8

**VEDANTES**







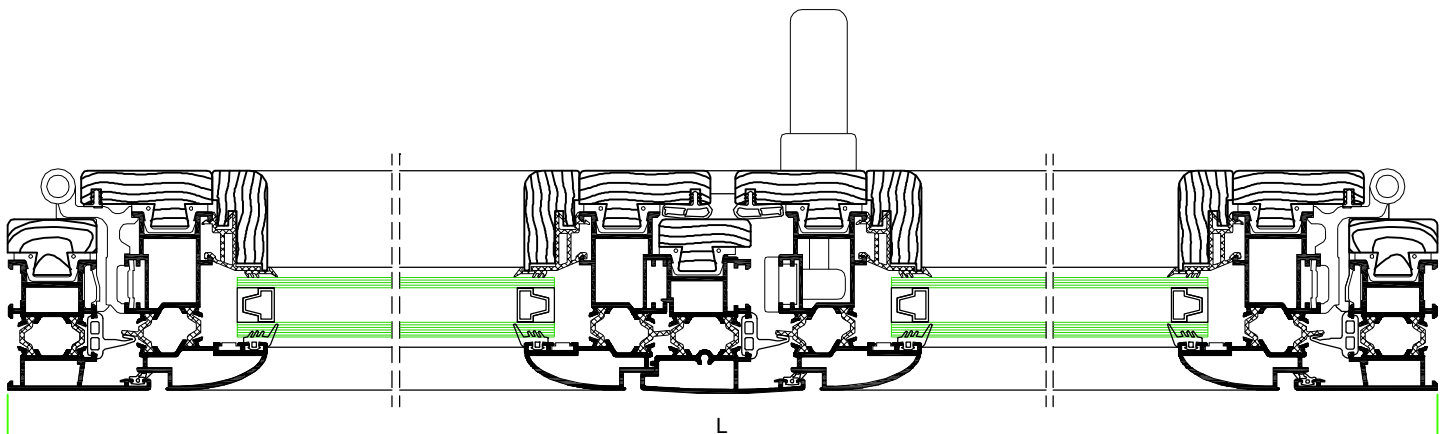

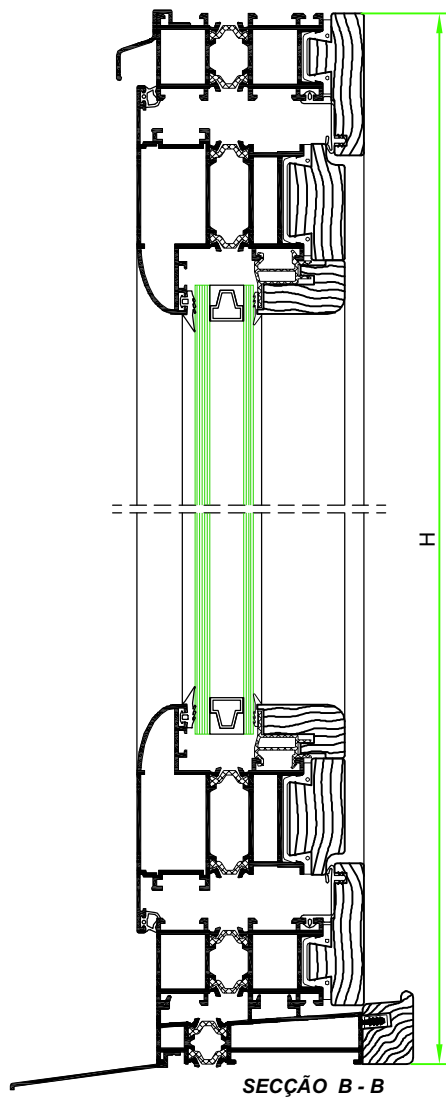
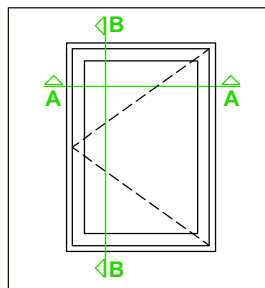





Des.	Ref.	Descrição	Quant.	Medida
	30 21 87 01	Junta interior	4 4	L/2 H
	30 21 87 02	Junta exterior	2 3	L H
	30 21 87 03	Junta central	2 3	L H

**VIDRO**

L/2-163	H-211
---------	-------

**SECÇÃO A - A**



**JANELA 1 FOLHA DE ABERTURA EXTERIOR**

**PERFIS**

Des.	Ref.	Descrição	Corte	Quant.	Medida
	AM-22	Aro fixo ab. ext.		2	L H-24
	AM-27	Aro móvel ab. ext.		2	L-59 H-83
	AM-16	Bite		2	L-202 H-226
	AXI-45	Pingadeira sup.		1	L
	AX-19	Barra cremone		2	Aprox. H/2
	AM-33	Condensação ab. ext.		1	L
	AZ-23	Pingadeira		1	L

**ACESSÓRIOS**

Ref.	Descrição	Quant.
30 21 87 09	Esquadro móvel	4
30 23 23 05	Parafuso transmissão ab. ext.	2
30 23 30 13	Dobradiças dir. ab. ext. janelas	2
30 24 30 73	Terminal de fecho ab. ext.	2
30 24 30 76	Apoio de folha ab. ext.	1
30 24 30 84	Complemento fecho 1F ab. ext.	2
30 24 87 28	Esquadro fixo ab. ext.	8
30 24 87 37	Esquadro ext. móvel ab. ext.	4
30 95 50 00	Cremone ab. ext.	1
30 90 20 41	Transmissão ab. ext.	1
30 95 50 40	Pastilha de alinhamento madeira	8
30 96 00 15	Esquadro alinhamento	4

**VEDANTES**

Des.	Ref.	Descrição	Quant.	Medida
	30 24 87 01	Junta interior ab. ext.	2	L H
	30 93 01 30	Junta exterior ab. ext.	2	L H

**VIDRO**

L-222	H-246
-------	-------

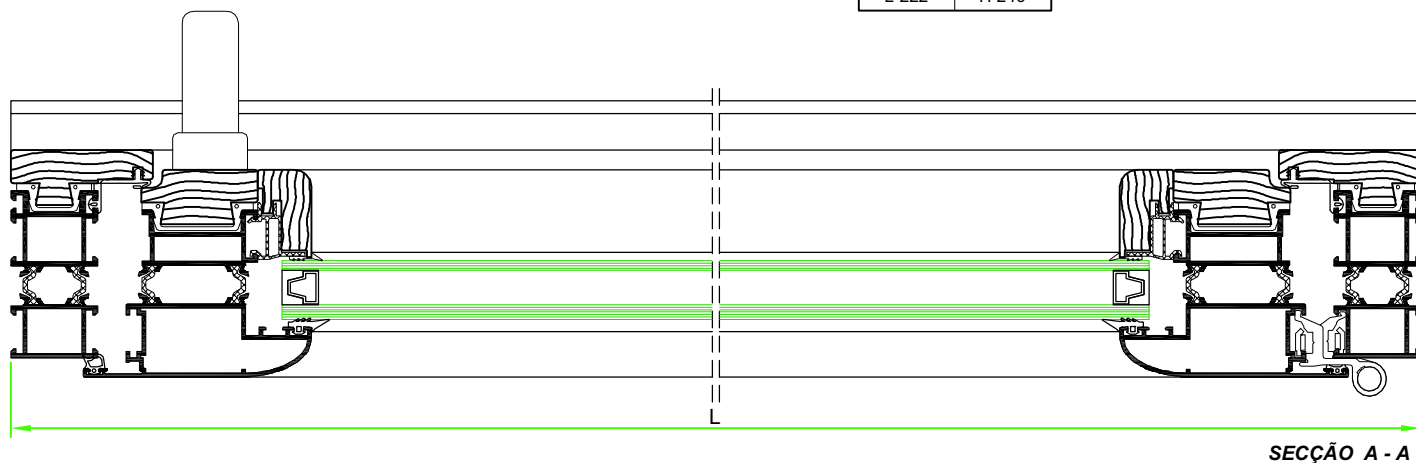

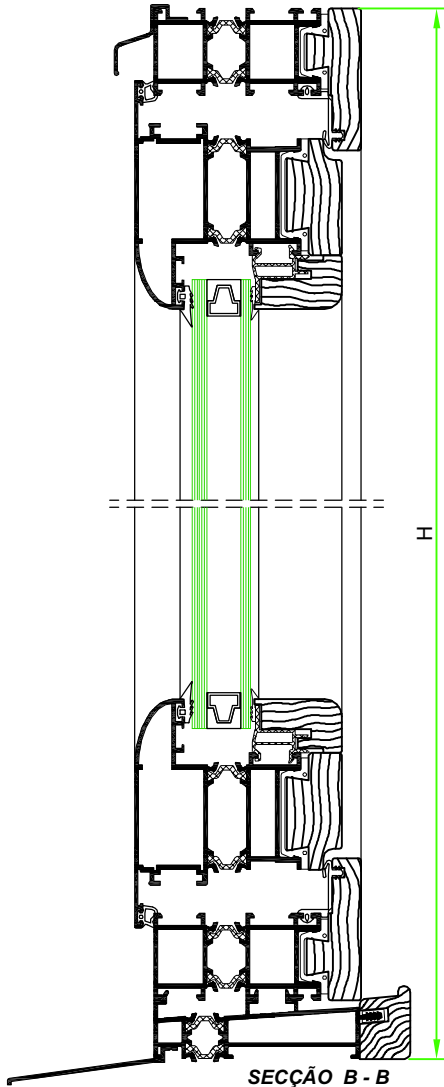
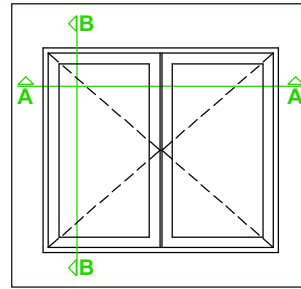
**JANELA 2 FOLHAS DE ABERTURA EXTERIOR**

**PERFIS**

Des.	Ref.	Descrição	Corte	Quant.	Medida
	AM-22	Aro fixo ab. ext.		2 2	L H-24
	AM-25	Inversor		1	H-154
	AM-27	Aro móvel ab. ext.		4 4	L/2-33 H-83
	AM-16	Bite		4 4	L/2-176 H-226
	AXI-45	Pingadeira sup.		1	L
	AX-19	Barra cremone		2	Aprox. H/2
	AM-33	Condensação ab. ext.		1	L
	AZ-23	Pingadeira		1	L

**ACESSÓRIOS**

Ref.	Descrição	Quant.
30 21 87 09	Esquadro móvel	8
30 23 23 05	Parafuso transmissão ab. ext.	2
30 23 30 13	Dobradiças dir. ab. ext. janelas	2
30 23 30 33	Dobradiças esq. ab. ext. janelas	2
30 24 30 73	Terminal de fecho ab. ext.	2
30 24 30 74	Complemento fecho 2F ab. ext.	2
30 24 30 76	Apoio de folha ab. ext.	2
30 24 30 77	Fecho 2ª folha ab. ext.	2
30 24 87 15	Jogo topos inversor ab. ext.	1
30 24 87 28	Esquadro fixo ab. ext.	8
30 24 87 37	Esquadro ext. móvel ab. ext.	8
30 95 50 00	Cremone ab. ext.	1
30 90 20 41	Transmissão ab. ext.	1
30 95 50 40	Pastilha de alinhamento madeira	12
30 96 00 15	Esquadro alinhamento	8

**VEDANTES**

Des.	Ref.	Descrição	Quant.	Medida
	30 24 87 01	Junta interior ab. ext.	2 3	L H
	30 93 01 30	Junta exterior ab. ext.	4 4	L/2 H

**VIDRO**

L/2-196	H-246
---------	-------

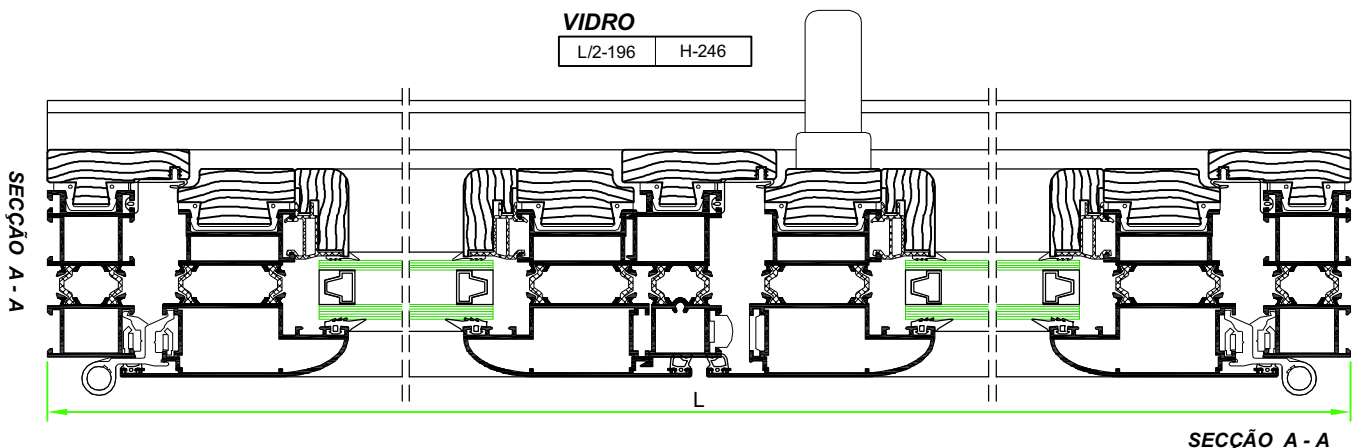
**SECÇÃO A - A**

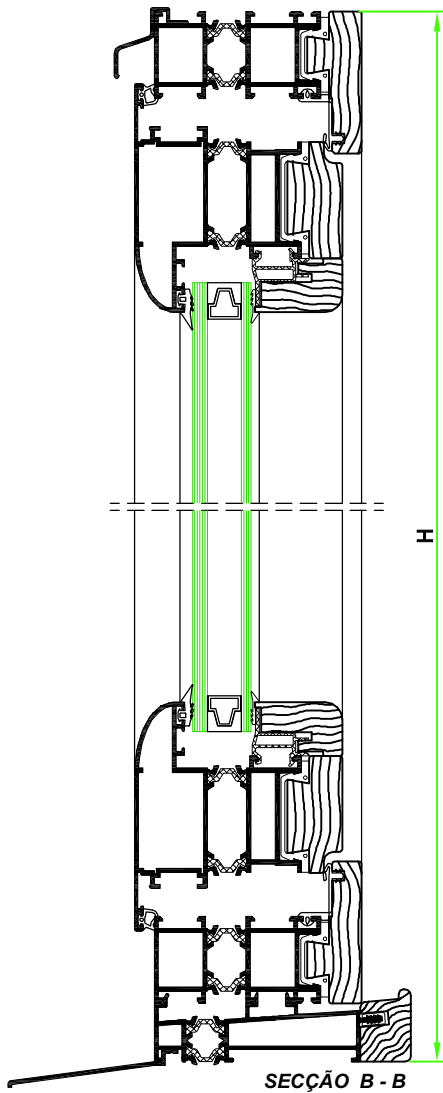
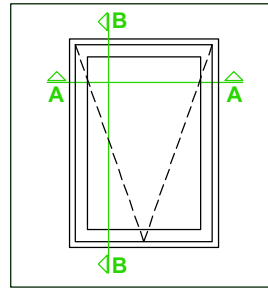

**JANELA 1 FOLHA PROJECTANTE**

**PERFIS**

Des.	Ref.	Descrição	Corte	Quant.	Medida
	AM-22	Aro fixo ab. ext.		2 2	L H-24
	AM-31	Aro móvel ab. ext. projectante		2 2	L-59 H-83
	AM-16	Bite		2 2	L-203 H-227
	AXI-45	Pingadeira sup.		1	L
	AX-19	Barra cremone		2	Aprox. H/2
	AM-33	Condensação ab. ext.		1	L
	AZ-23	Pingadeira		1	L
	AXi-31	Guia de abertura projectante		1	L-107
	AXi-32	Complemento ab. projectante		2	565

**ACESSÓRIOS**

Ref.	Descrição	Quant.
30 21 87 09	Esquadro móvel	4
30 23 23 05	Parafuso transmissão ab. ext.	2
30 24 30 73	Terminal de fecho ab. ext.	2
30 24 30 84	Complemento fecho 1F ab. ext.	2
30 24 87 28	Esquadro fixo ab. ext.	8
30 24 87 37	Esquadro ext. móvel ab. ext.	4
30 95 50 00	Cremone ab. ext.	1
30 90 20 41	Transmissão ab. ext.	1
30 90 04 90	Jogo compassos proj.	1
30 95 50 40	Pastilha de alinhamento madeira	8
30 96 00 15	Esquadro alinhamento	4

**VEDANTES**







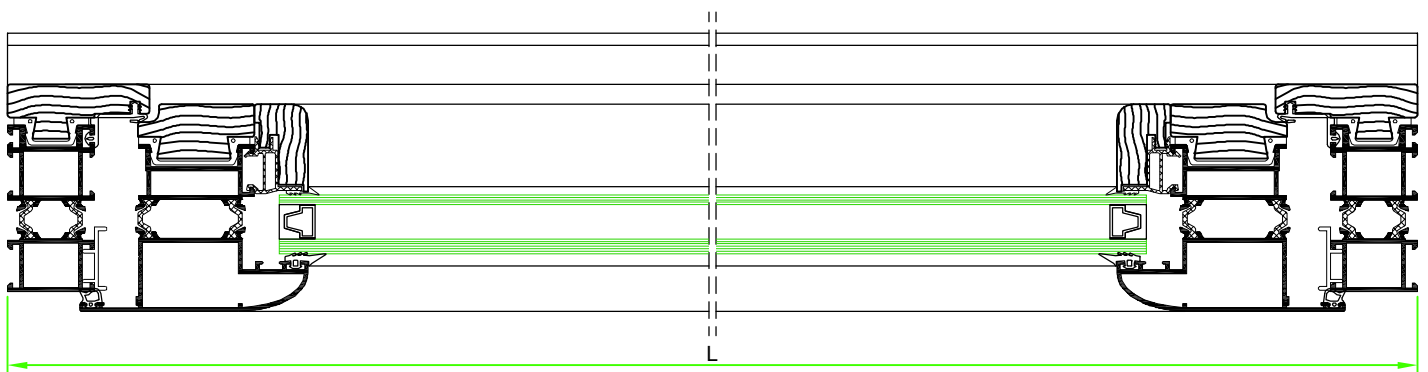

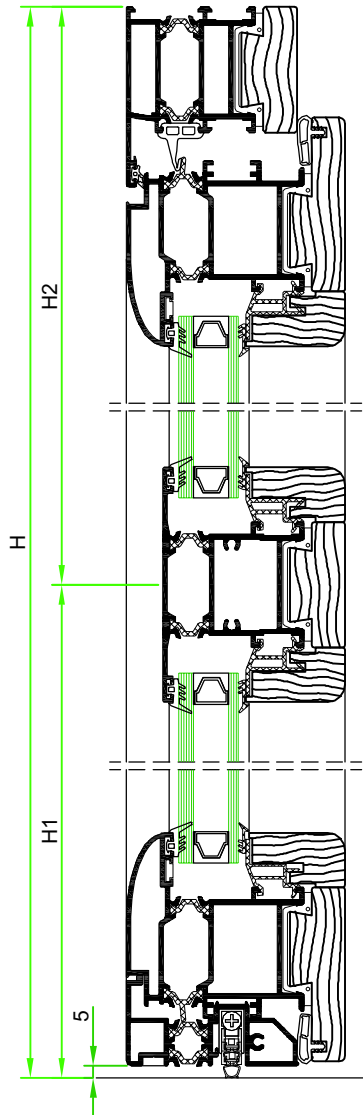
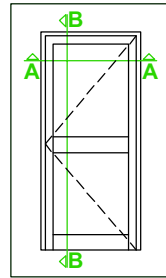







Des.	Ref.	Descrição	Quant.	Medida
	30 24 87 01	Junta interior ab. ext.	2 2	L H
	30 93 01 30	Junta exterior ab. ext.	2 2	L H

**VIDRO**

L-56	H-62
------	------

**SECÇÃO A - A**

**PORTA 1 FOLHA DE ABERTURA INTERIOR**

**PERFIS**



Des.	Ref.	Descrição	Corte	Quant.	Medida
	AM-8	Aro fixo		1	L
	AM-10	Aro móvel		2	L-91
	AM-11	Travessa		2	H-51
	AM-16	Bite		1	L-222
	AM-16	Bite		4	L-230
	AM-16	Bite		2	H2-141
	AM-36	Remate inf.		2	H1-103
	AM-36	Remate inf.		1	L

**ACESSÓRIOS**

Ref.	Descrição	Quant.
30 21 87 09	Esquadro aro fixo porta	4
30 21 87 10	Esquadro móvel porta	4
30 21 87 11	Canhão fechadura	1
*	Corta ventos inf.	1
30 25 87 70	Jogo topos remate inf.	1
30 92 05 10	Fechadura 3 pontos	1
30 95 50 40	Pastilha de alinhamento madeira	4
30 95 50 91	Jogo puxadores ouro	1
30 95 52 12	Dobradiças ouro	4
30 96 00 15	Esquadro alinhamento	4

\* Segundo a dimensão da folha

**VEDANTES**







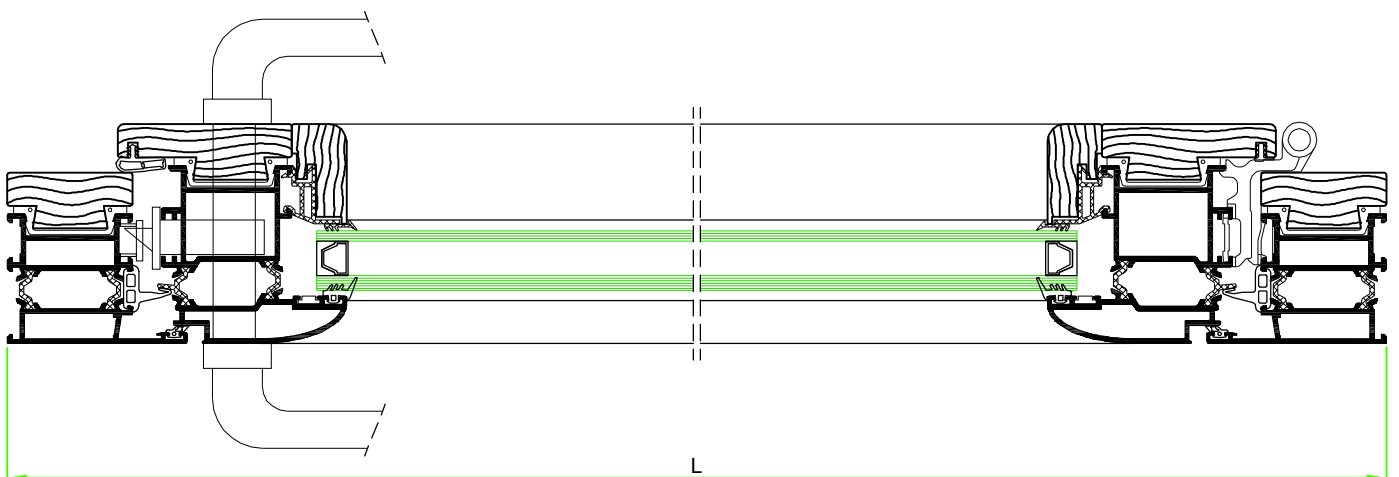

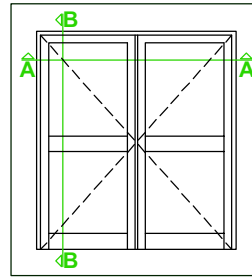
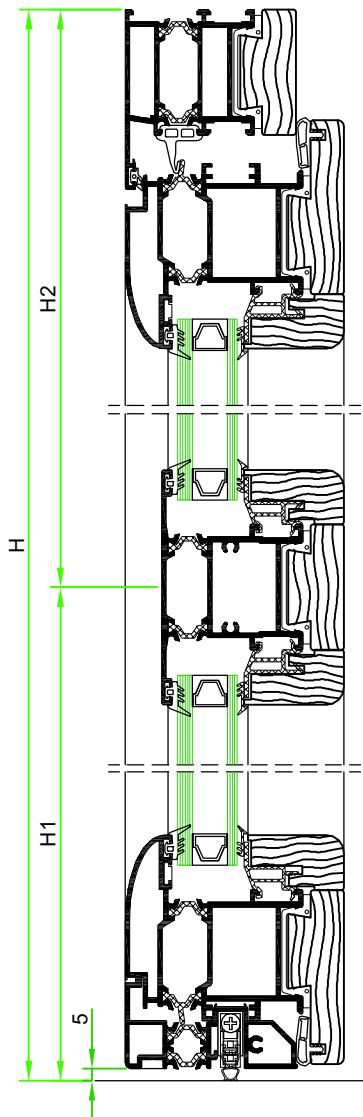



Des.	Ref.	Descrição	Quant.	Medida
	30 21 87 01	Junta interior	1	L
			2	H
	30 21 87 02	Junta exterior	1	L
			2	H
	30 21 87 03	Junta central	1	L
			2	H

**VIDRO**

L-252	H2-161
L-252	H1-123



**PORTA 2 FOLHAS DE ABERTURA INTERIOR**

**PERFIS**



Des.	Ref.	Descrição	Corte	Quant.	Medida
	AM-8	Aro fixo		1 2	L H
	AM-10	Aro móvel		4 4	L/2-52 H-51
	AM-11	Travessa		2	L/2-182
	AM-4	Inversor		1	H-87
	AM-16	Bite		8 4 4	L/2-190 H2-141 H1-103
	AM-36	Remate inf.		2	L/2

**ACESSÓRIOS**

Ref.	Descrição	Quant.
30 21 87 04	Jogo de fechos 2ª folha	1
30 21 87 09	Esquadro aro fixo porta	4
30 21 87 10	Esquadro móvel porta	8
30 21 87 11	Canhão fechadura	1
30 21 87 15	Jogo de topos inversor	1
*	Corta ventos inf.	2
30 25 87 70	Jogo topos remate inf.	2
30 92 05 10	Fechadura 3 pontos	1
30 95 50 40	Pastilha de alinhamento madeira	10
30 95 50 91	Jogo puxadores ouro	1
30 95 52 12	Dobradiças ouro	8
30 96 00 15	Esquadro alinhamento	8

\* Segundo a dimensão da folha

**VEDANTES**







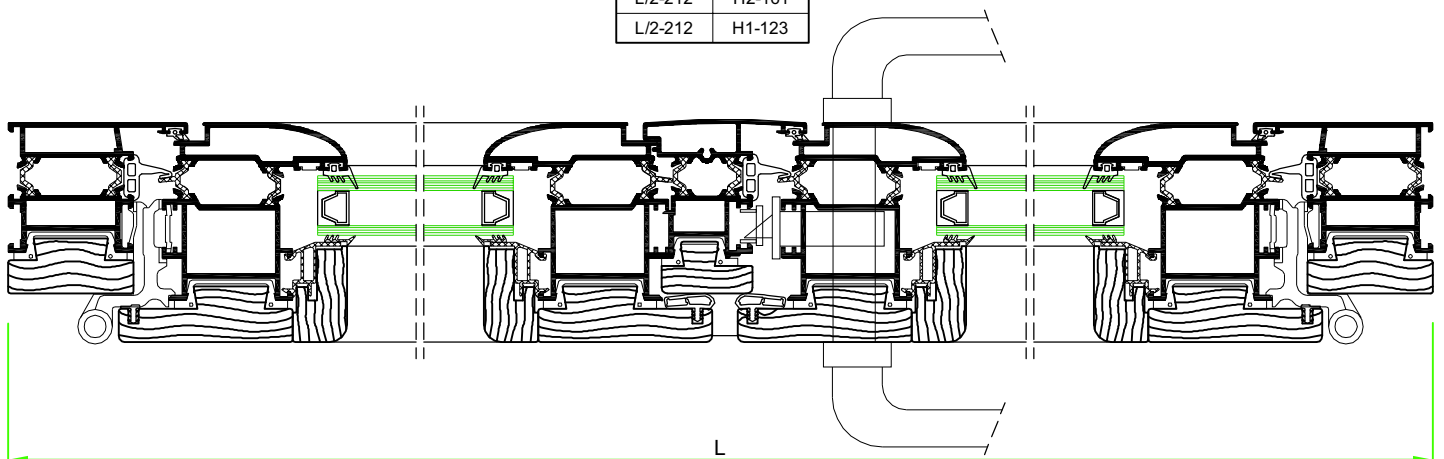

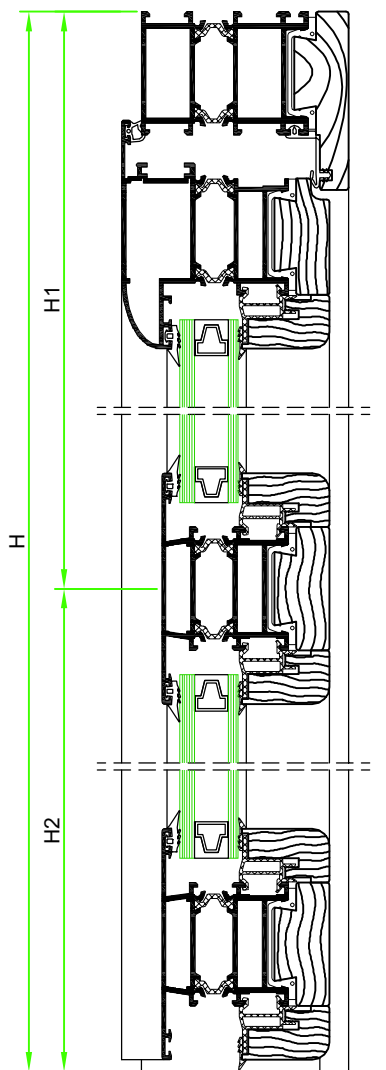
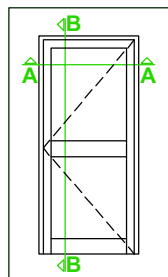
Des.	Ref.	Descrição	Quant.	Medida
	30 21 87 01	Junta interior	1 4	L H
	30 21 87 02	Junta exterior	1 3	L H
	30 21 87 03	Junta central	1 3	L H

**VIDRO**

L/2-212	H2-161
L/2-212	H1-123





**PORTA 1 FOLHA DE ABERTURA EXTERIOR**

**PERFIS**

Des.	Ref.	Descrição	Corte	Quant.	Medida
	AM-29	Aro fixo ab. ext.		1	L
				2	H
	AM-27	Aro móvel ab. ext.		1	L-89
				2	H-50
	AM-16	Bite		4	L-232
				2	H1-103
				2	H2-141
				1	L-232
	AM-6	Travessa		2	L-222

**ACESSÓRIOS**

Ref.	Descrição	Quant.
30 21 87 09	Esquadro aro fixo	2
30 21 87 11	Canhão fechadura	1
30 21 87 12	União topos porta int.	4
30 21 87 13	União topos porta ext.	4
30 23 20 13	Dobradiças dir. ab. ext. porta	3
30 24 87 37	Esquadro ext. móvel ab. ext.	2
30 24 87 48	Esquadro fixo porta ab. ext.	4
30 92 05 10	Fechadura 3 pontos	1
30 95 50 40	Pastilha de alinhamento madeira	4
30 95 50 91	Jogo puxadores ouro	1
30 96 00 15	Esquadro alinhamento	2

**VEDANTES**







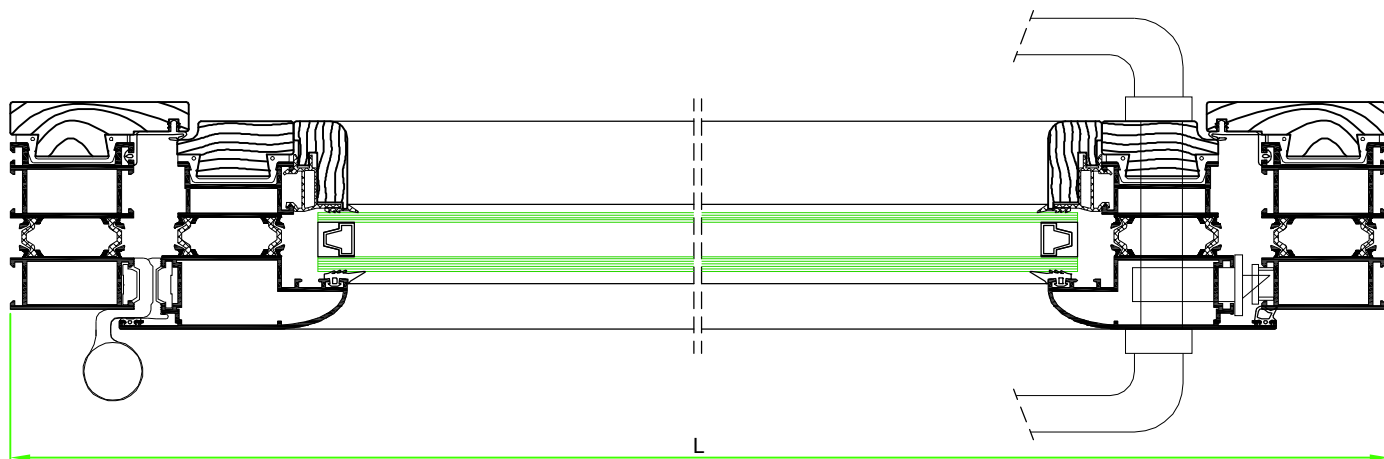

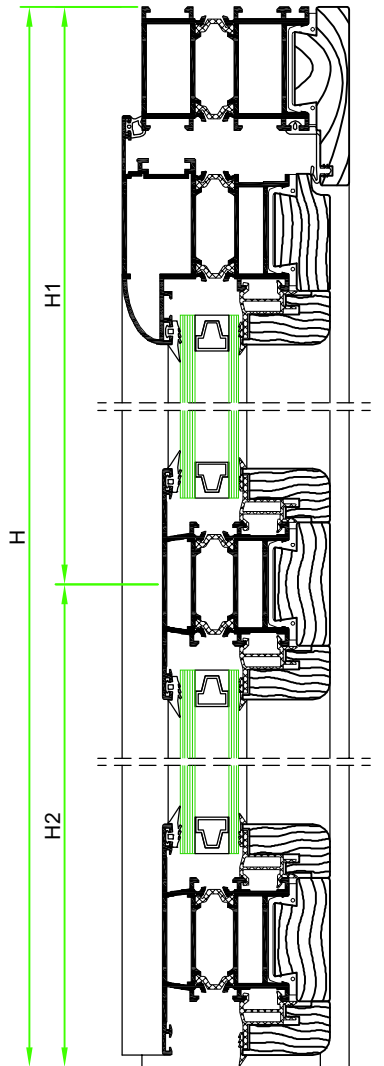
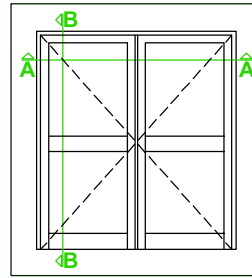



Des.	Ref.	Descrição	Quant.	Medida
	30 24 87 01	Junta interior ab. ext.	1	L
			2	H
	30 93 01 30	Junta exterior ab. ext.	1	L
			2	H

**VIDRO**

L-126	H1-81
L-126	H2-62





**PORTA 2 FOLHAS DE ABERTURA EXTERIOR**

**PERFIS**

Des.	Ref.	Descrição	Corte	Quant.	Medida
	AM-29	Aro fixo ab. ext.		1	L
	AM-27	Aro móvel ab. ext.		2	L/2-48
	AM-25	Inversor ab. ext.		4	H-50
	AM-25	Inversor ab. ext.		1	H-80
	AM-16	Bite		8	L/2-191
				4	H1-103
				4	H2-141
				2	L/2-191
	AM-6	Travessa		4	L/2-181

**ACESSÓRIOS**

Ref.	Descrição	Quant.
30 21 87 09	Esquadro aro fixo	2
30 21 87 11	Canhão fechadura	1
30 21 87 12	União topos porta int.	4
30 21 87 13	União topos porta ext.	4
30 23 20 13	Dobradiças dir. ab. ext. porta	3
30 23 20 33	Dobradiças esq. ab. ext. porta	3
30 24 87 15	Jogo topos inversor ab. ext.	1
30 24 87 37	Esquadro ext. móvel ab. ext.	4
30 24 87 48	Esquadro aro fixo porta ab. ext.	4
30 92 05 10	Fechadura 3 pontos	1
30 95 50 40	Pastilha de alinhamento madeira	4
30 95 50 91	Jogo puxadores ouro	1
30 96 00 15	Esquadro alinhamento	2

**VEDANTES**







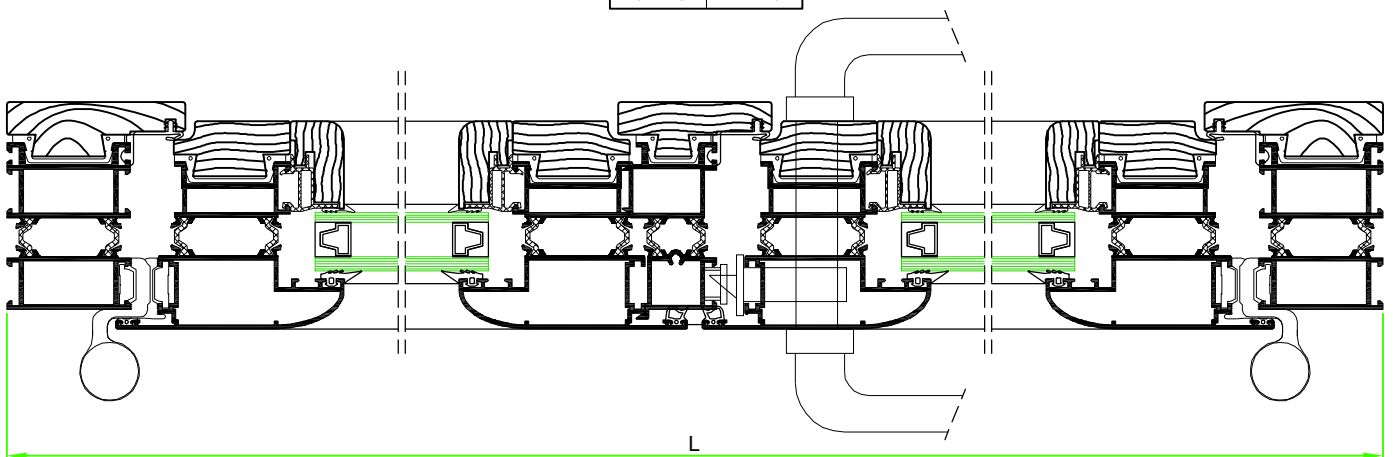

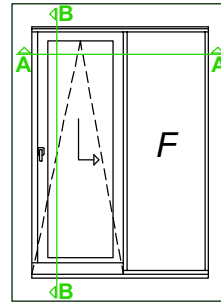
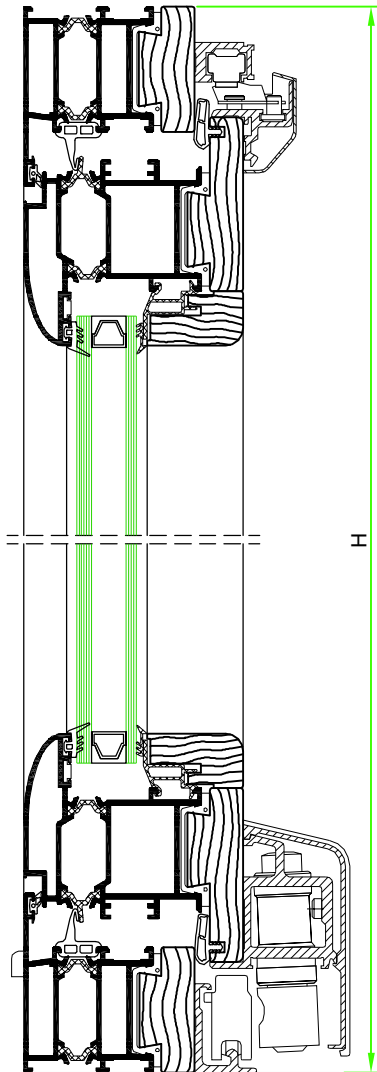
Des.	Ref.	Descrição	Quant.	Medida
	30 24 87 01	Junta interior ab. ext.	1	L
			3	H
	30 93 01 30	Junta exterior ab. ext.	2	L/2
			4	H

**VIDRO**

L/2-210	H1-162
L/2-210	H2-123





**PORTA OSCILO-PARALELA COM FIXO LATERAL**

**PERFIS**

Des.	Ref.	Descrição	Corte	Quant.	Medida
	AM-8	Aro fixo		2	L
	AM-10	Aro móvel		2	L1-66
	AM-6	Travessa		1	H-94
	AM-16	Bite		2	L/1-206 H-232 (L-L1)-76 H-102
	AX-19	Barra cremone		2	Aprox. H/2

**ACESSÓRIOS**

Ref.	Descrição	Quant.
30 21 87 09	Esquadro aro fixo	8
30 21 87 10	Esquadro móvel porta	4
30 21 87 12	União topos porta int.	2
30 21 87 13	União topos porta ext.	2
30 92 01 00	Goteiras	4
30 95 50 40	Pastilha de alinhamento madeira	8
30 95 52 20	Puxador simples ouro	1
30 95 52 24	Transmissão simples	1
30 96 00 15	Esquadro alinhamento	4
---	Kit oscilo - paralela	1

**VEDANTES**

Des.	Ref.	Descrição	Quant.	Medida
	30 21 87 01	Junta interior	2	L1 H
	30 21 87 02	Junta exterior	2	L1 H
	30 21 87 03	Junta central	2	L1 H







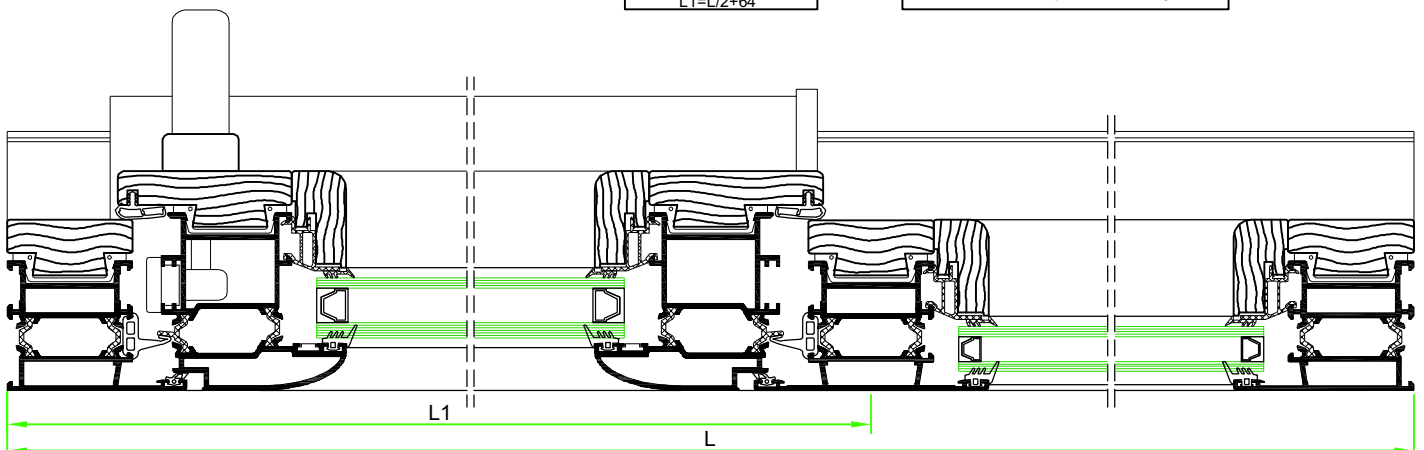

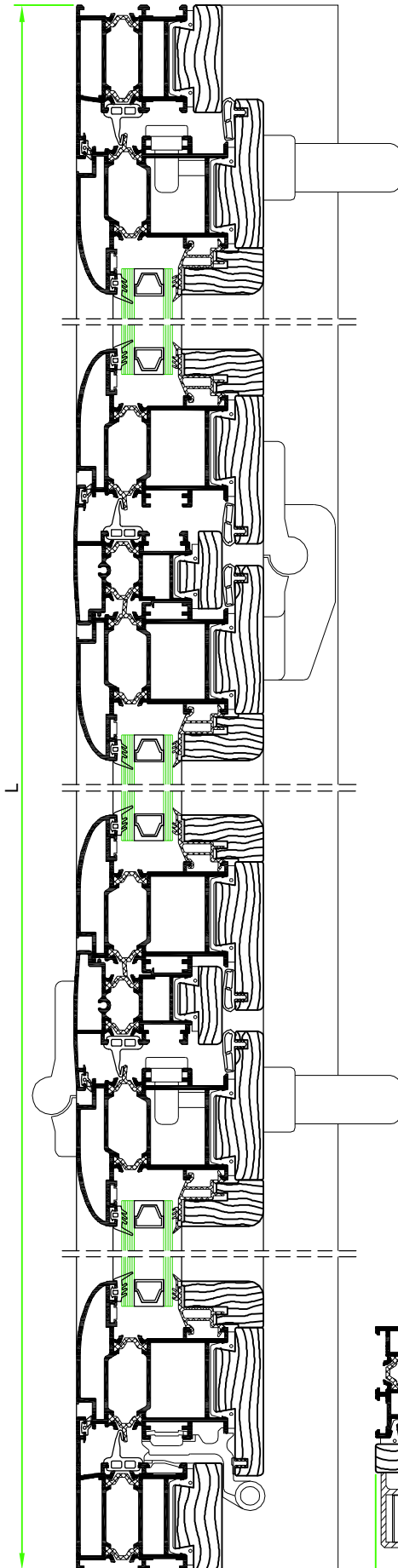
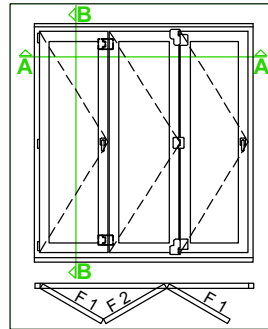



**VIDRO**

L1-226	H-252
(L-L1)-96	H-121
Para vidros iguais L1=L/2+64	

	Mínimo	Máximo
Largura da folha	700 mm	1650 mm
Altura da folha	850 mm	2400 mm
Peso máximo por folha 150 Kg		





**PORTA 3 FOLHAS HARMÔNIO**

**SECÇÃO A - A**
**PERFIS**

Des.	Ref.	Descrição	Corte	Quant.	Medida
	AM-8	Aro fixo		2 2	L H-51
	AM-10	Aro móvel		4 2 6	L/3-14 L/3-88 H-142
	AM-04	Inversor		2	H-214
	AM-16	Bite		4 2 6	L/3-154 L/3-228 H-280
	AX-19	Barra cremone		4	Aprox. H/2
	AM-13	Suplemento harmonio		1	L

**ACESSÓRIOS**

Ref.	Descrição	Quant.
30 21 87 09	Esquadro aro fixo	8
30 21 87 10	Esquadro móvel porta	12
30 21 87 15	Jogo topos inversor	2
30 92 01 00	Goteiras	4
30 95 50 40	Pastilha de alinhamento madeira	16
30 95 52 25	Transmissão dupla	2
30 95 52 12	Dobradiças ouro	3
30 95 52 20	Puxador simples ouro	2
30 96 00 15	Esquadro alinhamento	12
--- ---	Kit harmônio	1

**VEDANTES**

Des.	Ref.	Descrição	Quant.	Medida
	30 21 87 01	Junta interior	6 6	L/3 H
	30 21 87 02	Junta exterior	2 4	L H
	30 21 87 03	Junta central	2 4	L H

**VIDRO**

L/3-174	H-300
L/3-248	H-300

	Mínimo	Máximo
Largura da folha	600 mm	900 mm
Altura da folha	850 mm	2400 mm

Peso máximo por folha 80 Kg

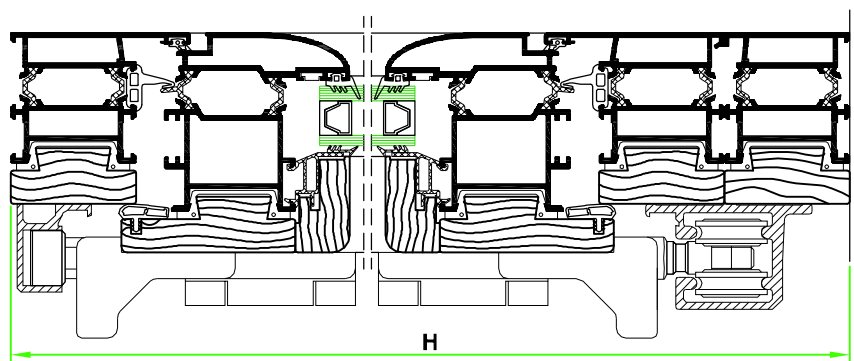
**SECÇÃO B - B**