

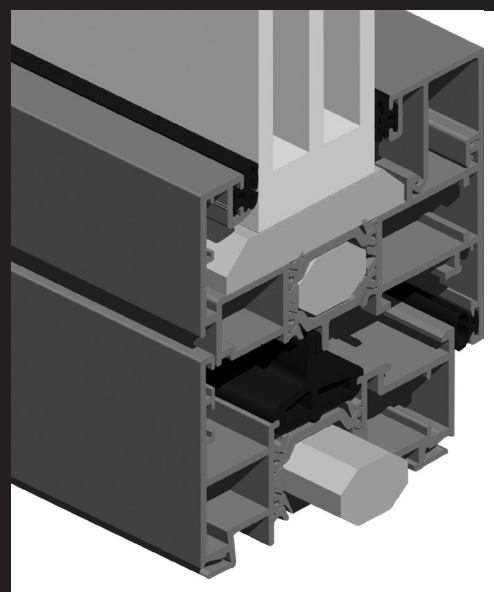

anicolor

Sistemas de Aluminio

Sistema Aji



Rotura térmica 70 mm

Sistema AJi

Sistema de batente com RPT - 70 mm

Características do sistema

Sistema de batente com rotura térmica de elevadas prestações térmicas e acústicas.

O sistema AJi possibilita a execução de 3 versões de caixilharia:

1. Linha recta;
2. Linha curva;
3. Linha oval.

O sistema AJi permite a aplicação de vidros duplos ou triplos de alto rendimento de modo a responder às exigências de isolamento térmico e acústico.

Com um óptimo isolamento térmico aliado à aplicação de um inovador produto designado por bagueete ThermoProfile, o Sistema AJi proporciona elevadas prestações de conforto e de economia energética.

Perfis de alumínio

Os perfis de alumínio são extrudidos na liga de alumínio 6060 para arquitectura de acordo com norma NP EN 12020-02.

Rotura térmica obtida por inserção de varetas isolantes de poliamida tipo ómega de 24 mm reforçadas com 25% de fibra de vidro. Espessura média dos perfis de alumínio de 1.7 mm.

Aros fixos

Secção dos aros fixos de 70 mm com tripla câmara;

Perfis com rotura térmica com varetas de poliamida tipo ómega de 24 mm;

Aros fixos com duplo esquadro de aperto rápido e esquadros de alinhamento para montagem a meia esquadria;

Travessas com dupla união para um aperto mais eficaz;

Aros fixos tradicionais para o mercado interno;

Aros fixos com clip exterior e aba de remate directa de 25 mm ou 45 mm para o mercado francês;

Aro fixo com clip exterior e interior para aplicação de remate de 30, 50 ou 80 mm para o mercado francês;

Aro fixo de ligação ao sistema de correr com rotura térmica CW.

Aros móveis

Secção dos aros móveis de 78 mm com tripla câmara;

Aros móveis com rotura térmica através de varetas de poliamidas tipo ómega de 24 mm;

Aros móveis com duplo esquadro de aperto rápido e esquadros de alinhamento para montagem a meia esquadria;

Perfil inversor com olhal para uma melhor aplicação do topo inversor.

Dimensionamento e manobralidade

Dimensões mínimas - máximas de folha: 340 mm - 1700 mm (L); 340 mm - 3000 mm (H);

Peso máximo para janelas ou portas de sacada com oscilo-batente até 170 Kg;

Peso máximo para portas de entrada até 160 Kg/folha;

Possibilidades de abertura: fixo, batente interior 1 ou 2 folhas com ou sem oscilo-batente, batente exterior, basculante, projectante, hármonio e oscilo-paralela;

Solução de perfil para portas pedonais ou de sacada de abertura interior ou exterior segundo norma PMR (pessoas com mobilidade reduzida);

Enchimento para vidro duplo ou triplo desde 20 mm até 55 mm;

Estanquidade assegurada através de juntas duplas em EPDM (interior e central).

Performances

Sistema certificado por laboratório notificado para Ensaio Tipo Inicial (ITT) de acordo com a norma de produto EN 14351-1 para efeitos de Marcação CE.

Categorias alcançadas na avaliação do sistema AJi:

1. Permeabilidade ao ar: Classe 4 (norma de ensaio EN 1026)
2. Estanquidade à água: Classe E900 (norma de ensaio EN 1027)
3. Resistência ao vento: Classe C5 (norma de ensaio EN 12211)

Coefficiente de transmissão térmica de vão de 2 folhas com 1.20 m x 1.50 m com vidro $U_g = 0.5 \text{ W/m}^2\text{K}$ com intercalar efeito "Warm Edge":

• $U_w = 1.26 \text{ W/m}^2\text{K}$

Coefficiente de atenuação acústica de vão de 2 folhas:

• $R_w (C ; C_{tr}) = 42 \text{ dB} (-1 ; -4)$

Zonas de aplicação segundo RCCTE (em função do valor U_g) : I1, I2, I3, V1, V2, V3

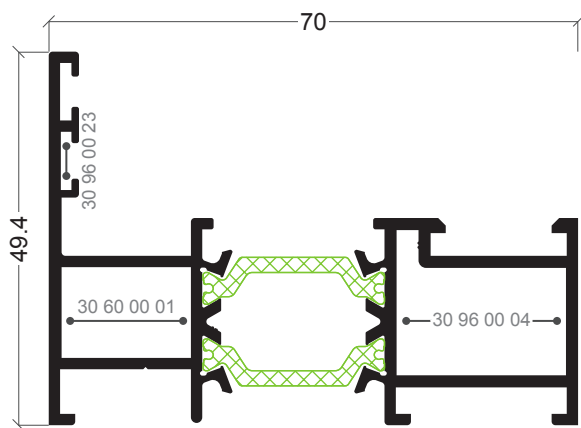

AJi-03
Aro fixo

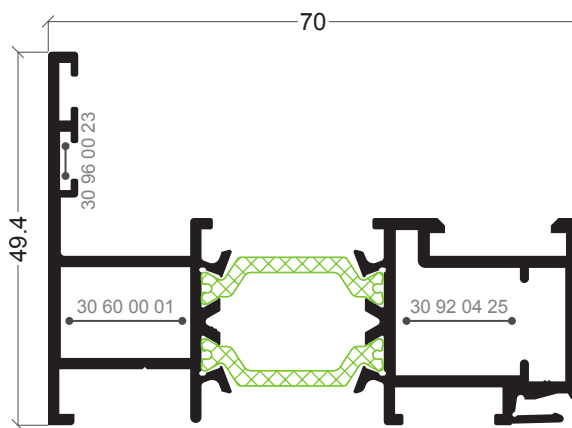

AJi-91
Aro fixo

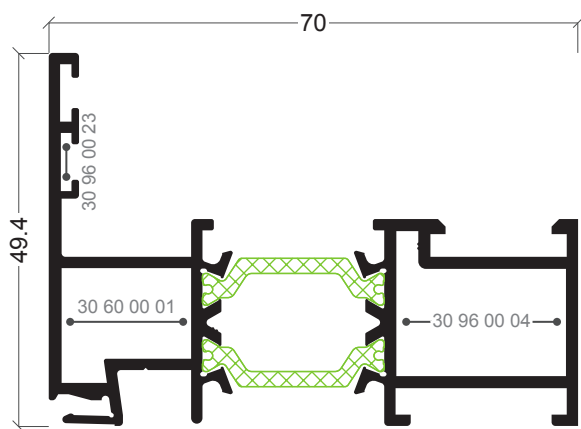

AJi-76
Aro fixo

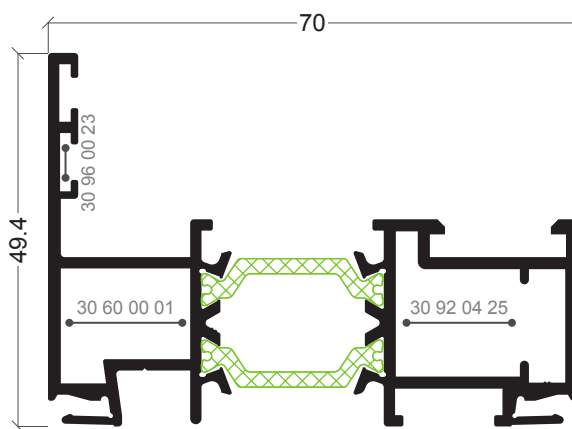

AJi-80
Aro fixo

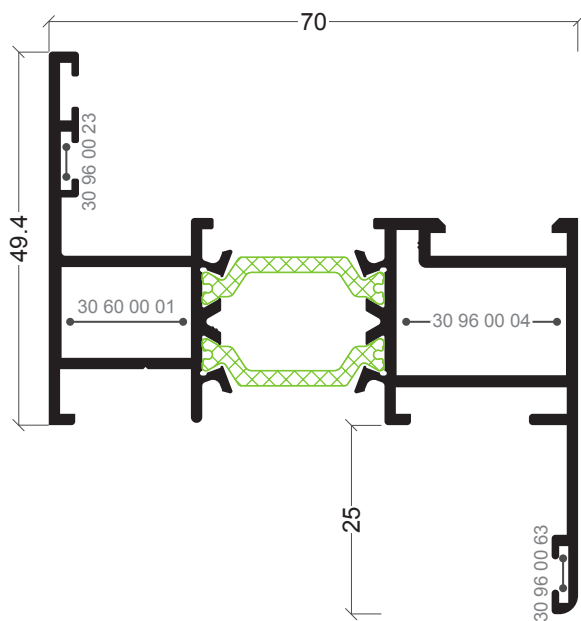

AJi-35
Aro fixo com remate 25 mm

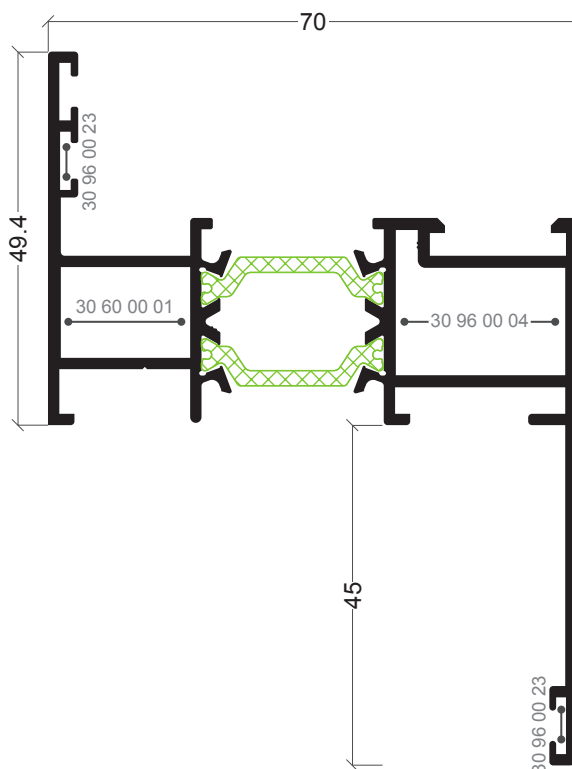

AJi-33
Aro fixo com remate 45 mm

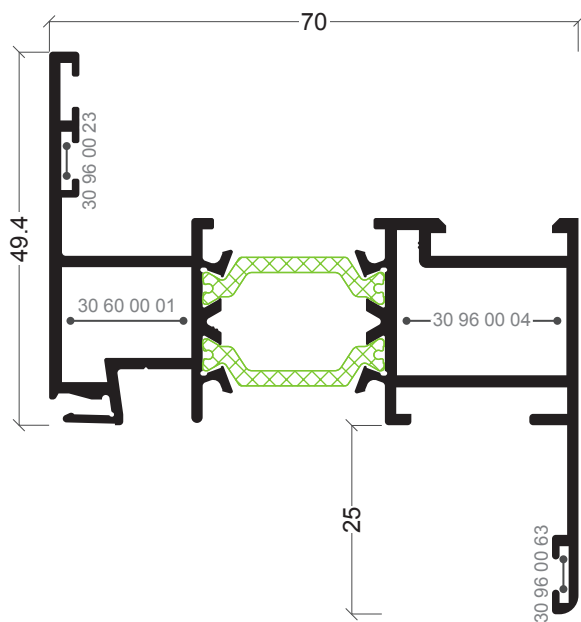

AJi-74
Aro fixo com remate 25 mm

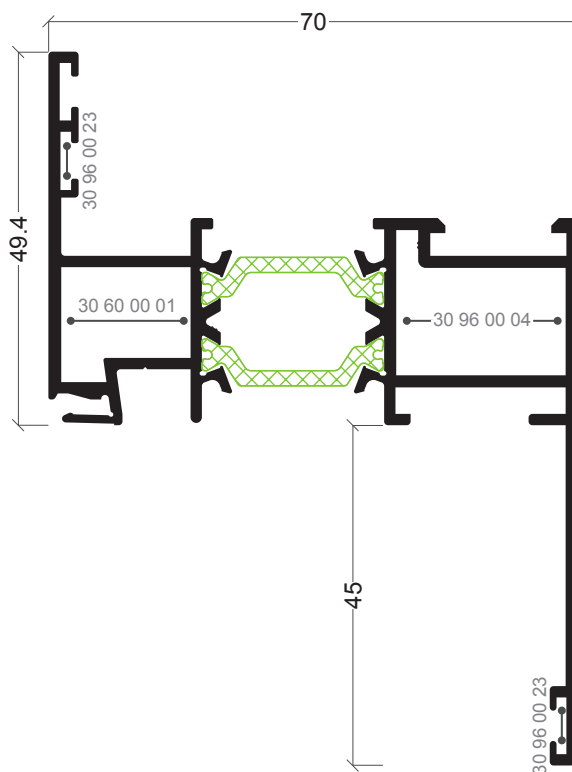

AJi-75
Aro fixo com remate 45 mm

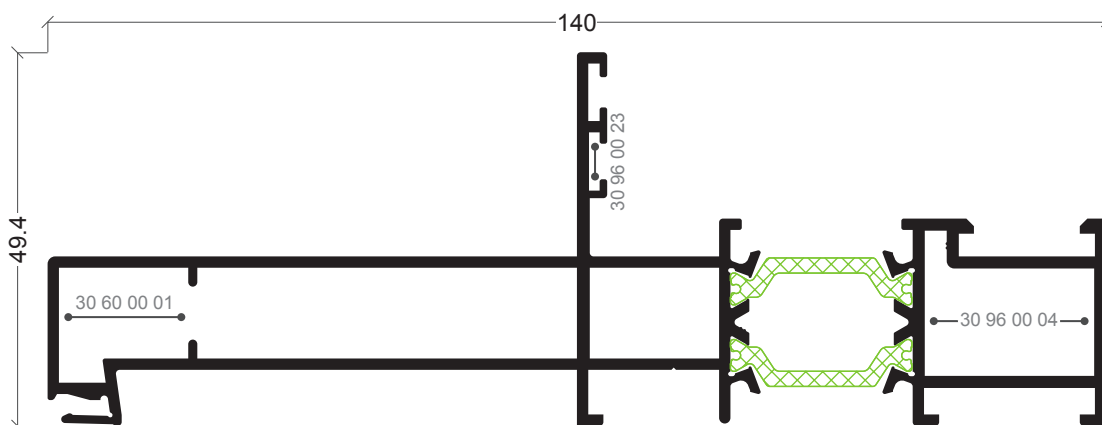

AJi-89
Aro fixo

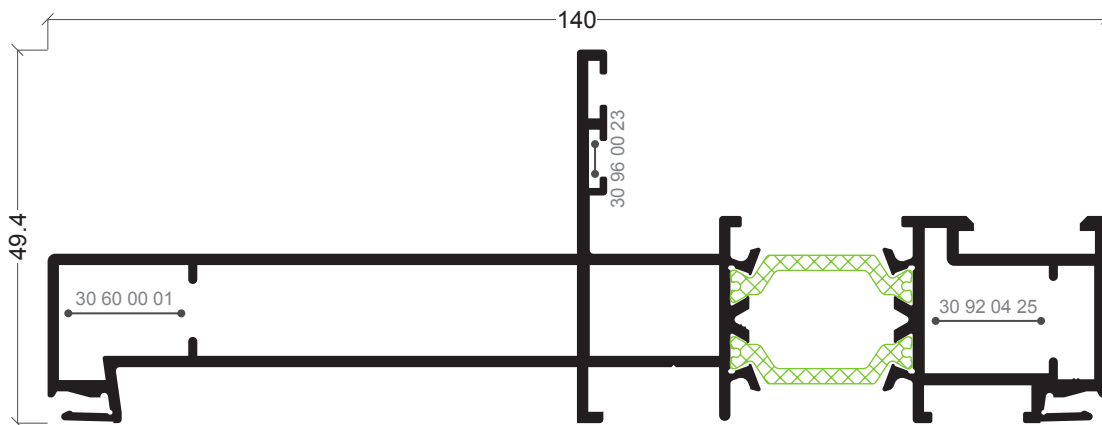

AJi-88
Aro fixo

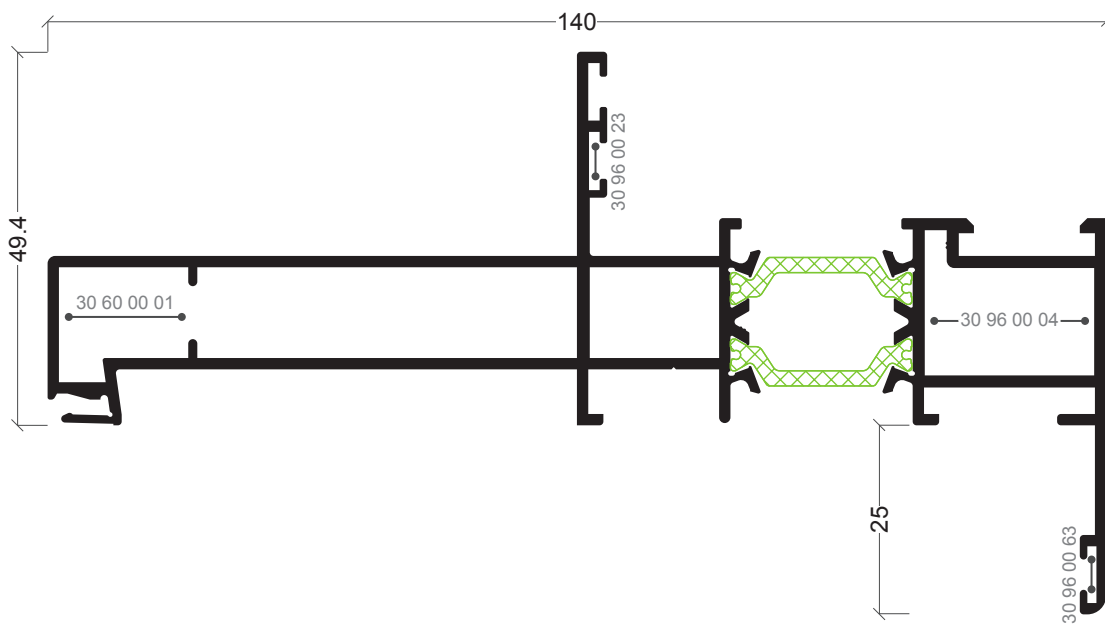

AJi-86
Aro fixo com remate 25 mm

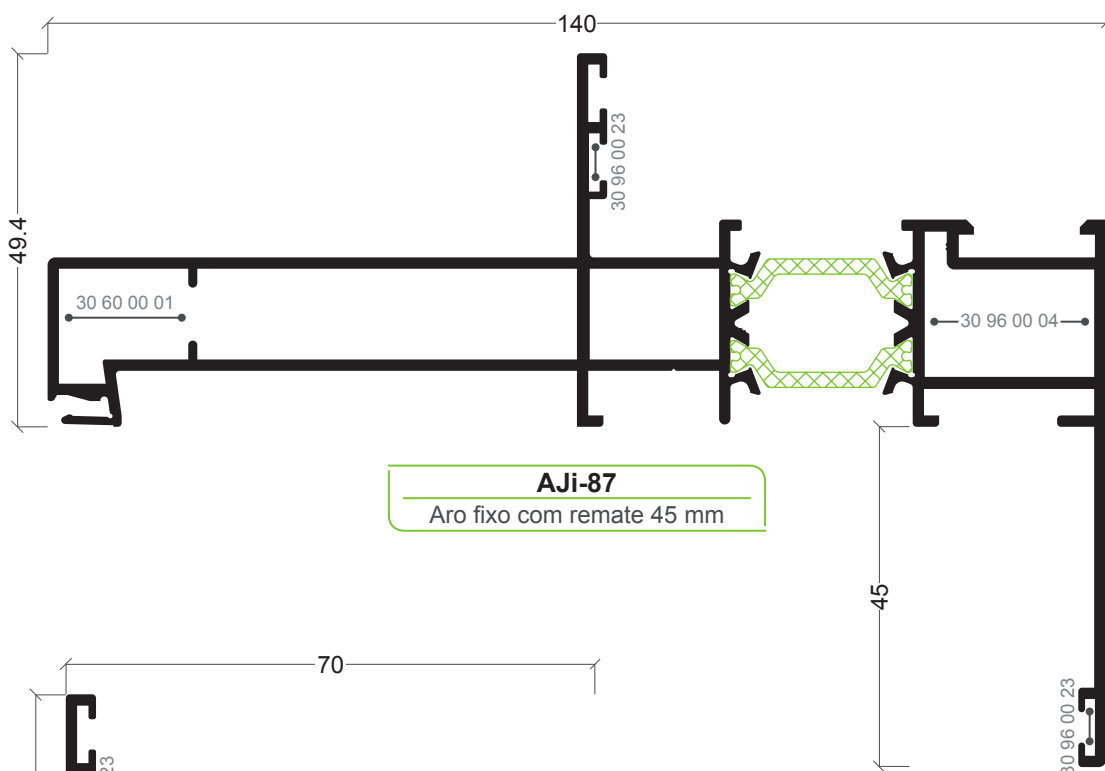

AJi-87
Aro fixo com remate 45 mm

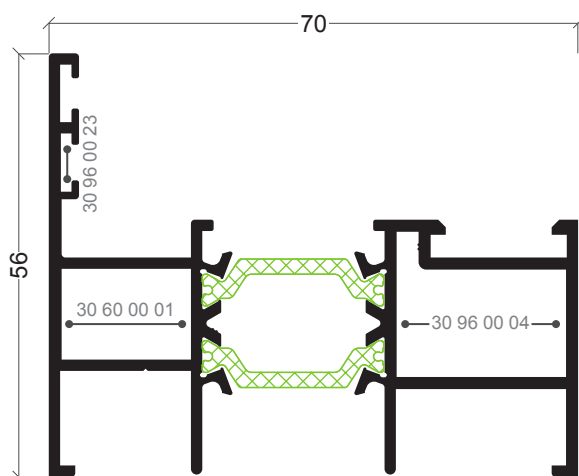

AJi-81
Aro fixo

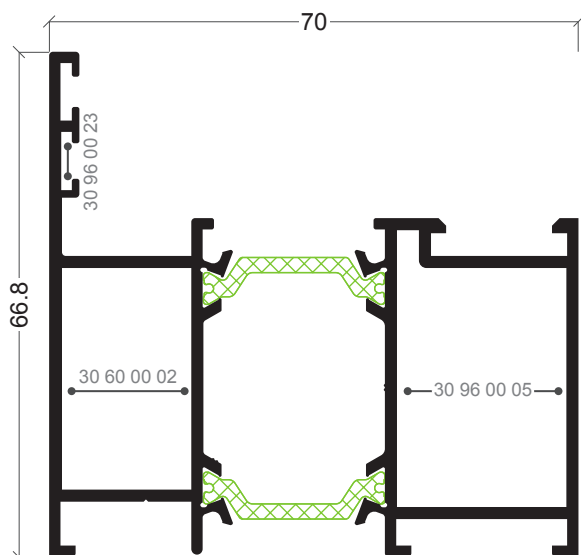

AJi-08
Aro fixo

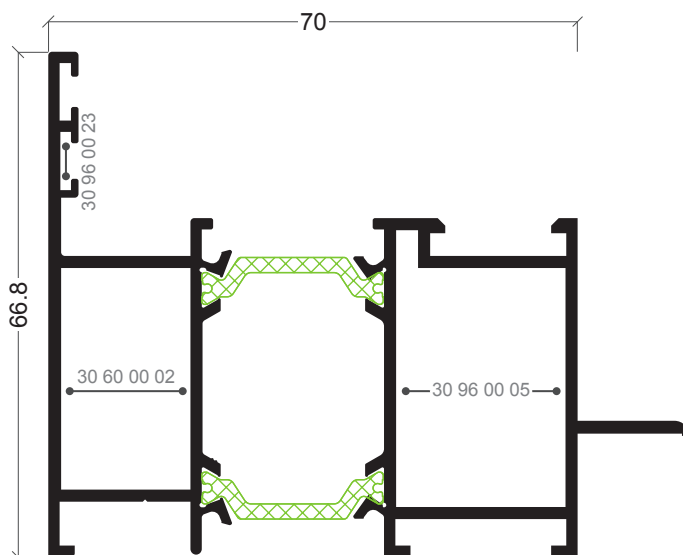

AJi-68
Aro fixo

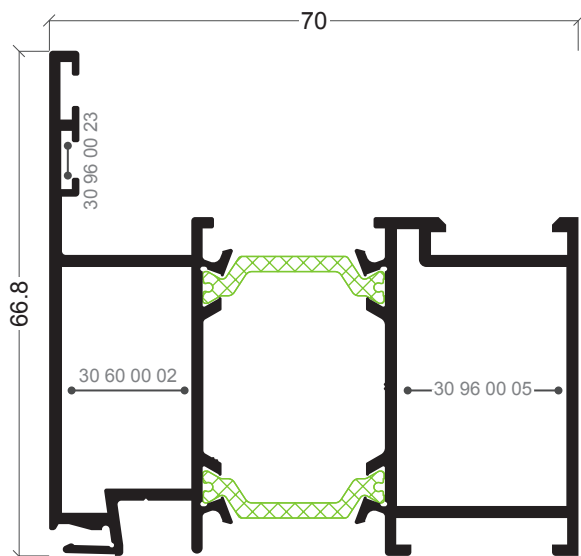

AJi-92
Aro fixo

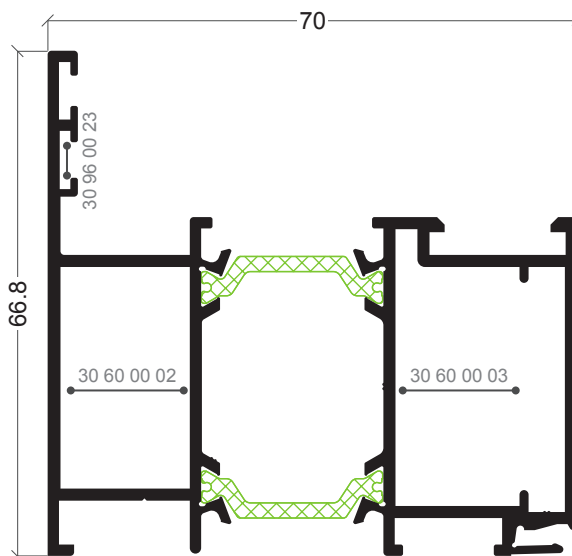

AJi-93
Aro fixo

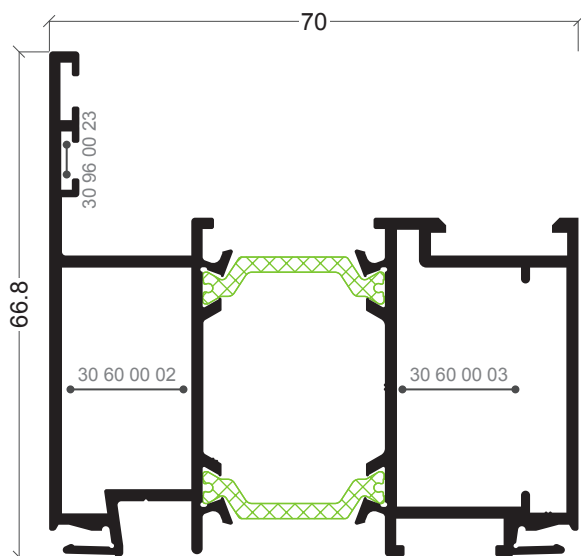

AJi-94
Aro fixo

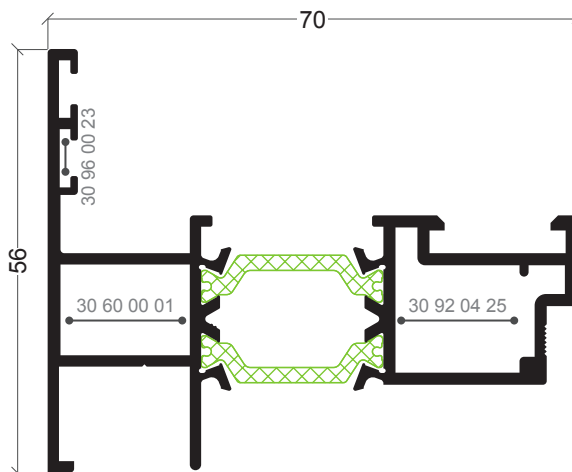

AJi-73
Inversor de sentido de abertura

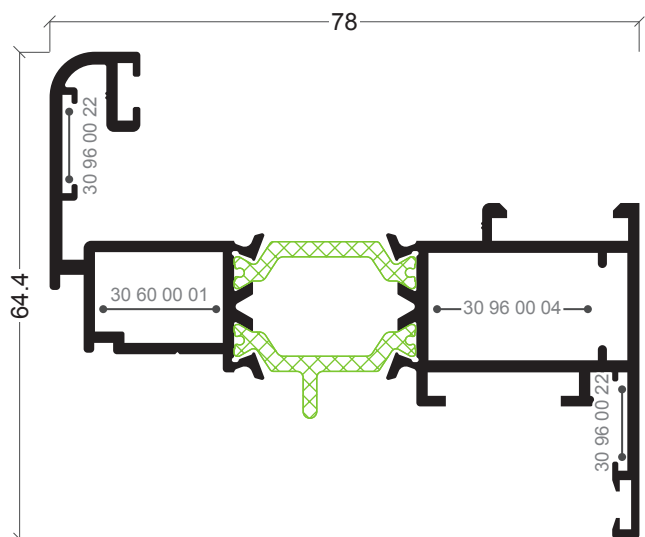

AJi-05
Aro móvil

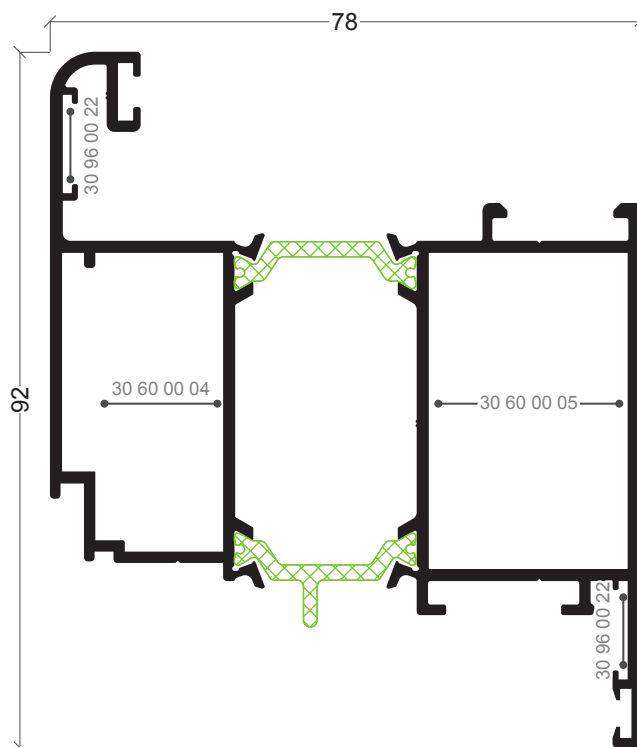

AJi-10
Aro móvil

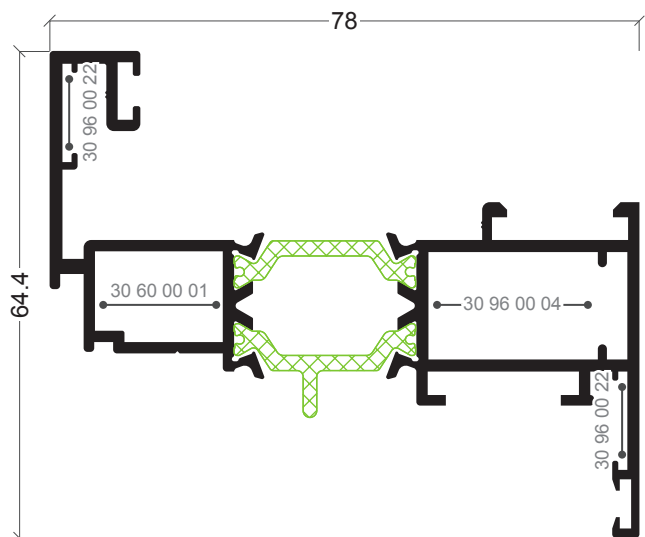

AJi-61
Aro móvil

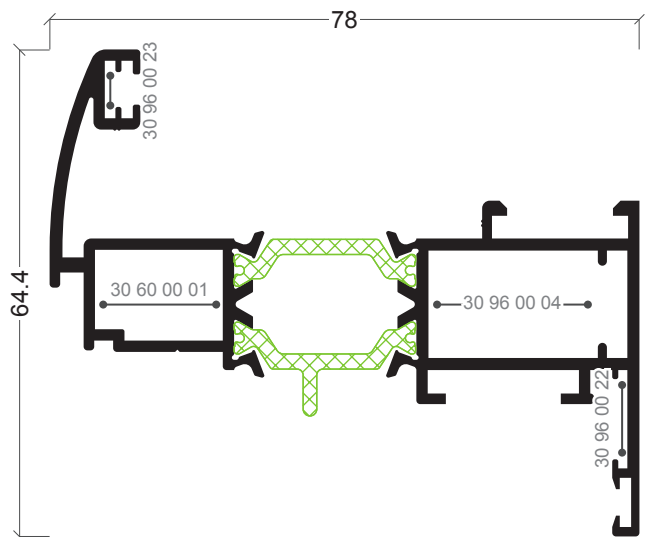

AJi-83
Aro móvil

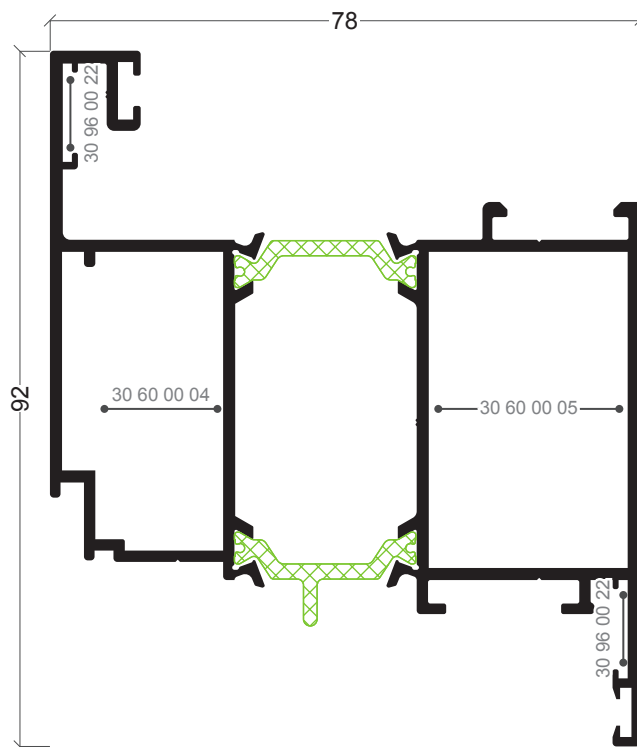

AJi-36
Aro móvil

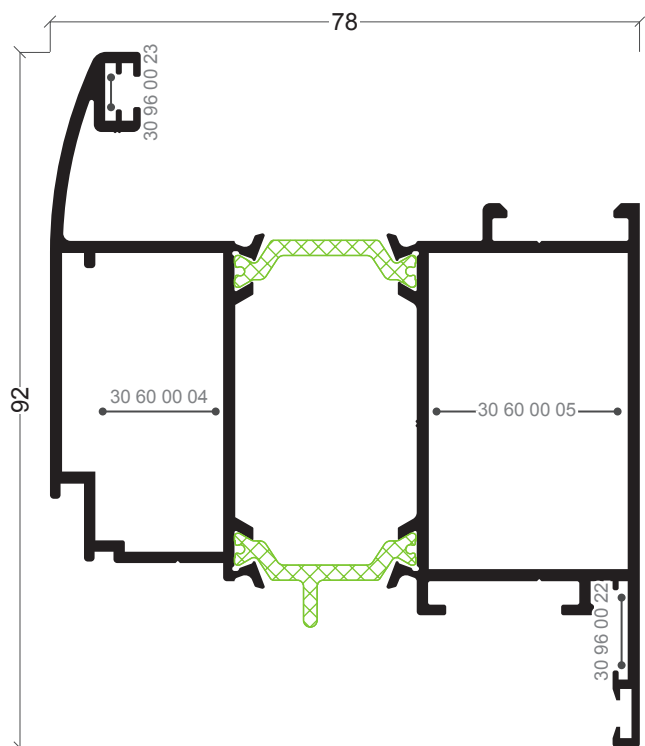

AJi-84
Aro móvel

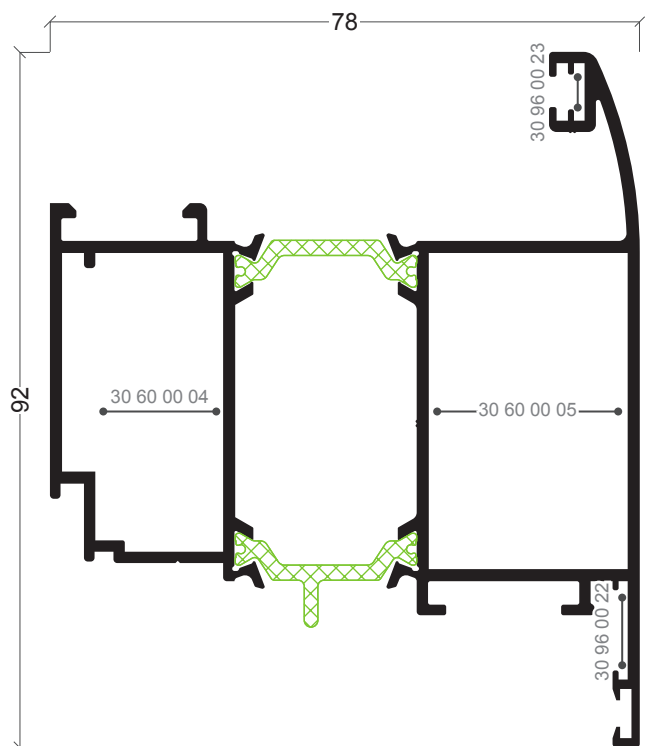

AJi-85
Aro móvel

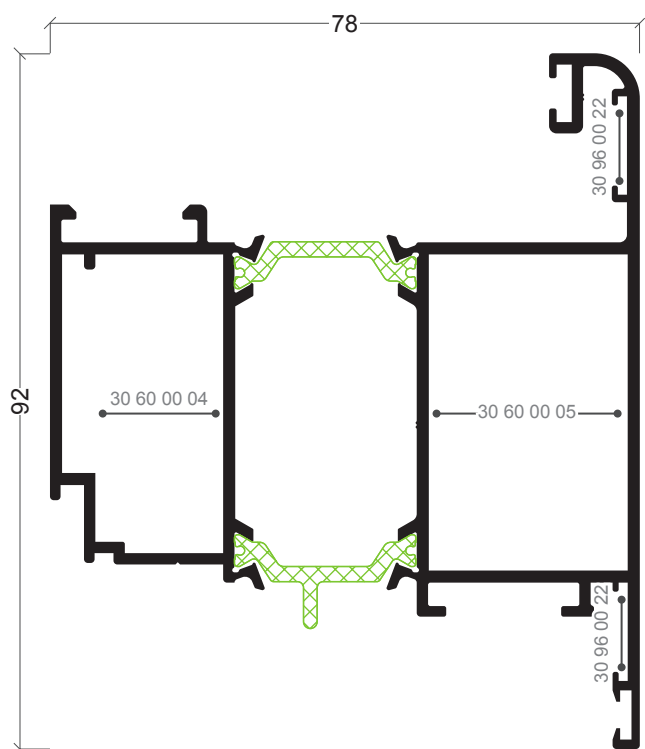

AJi-90
Aro móvel

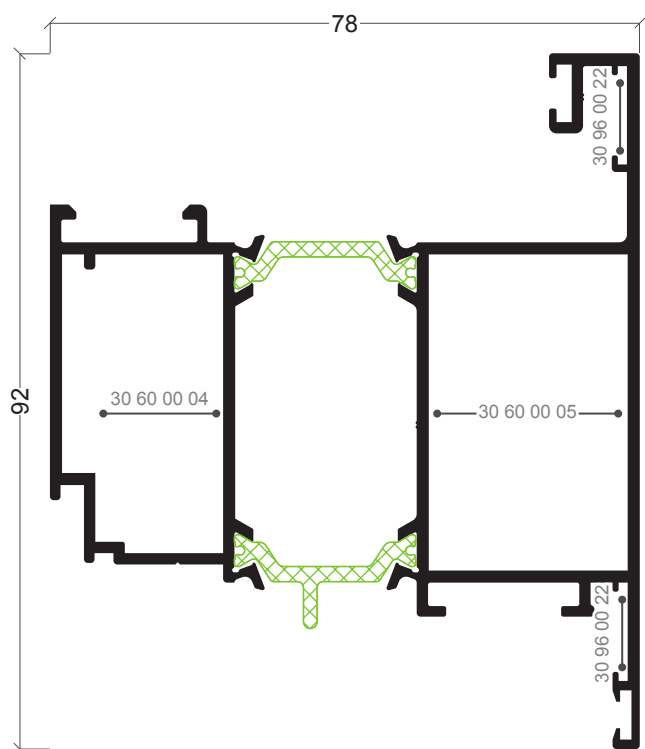

AJi-72
Aro móvel

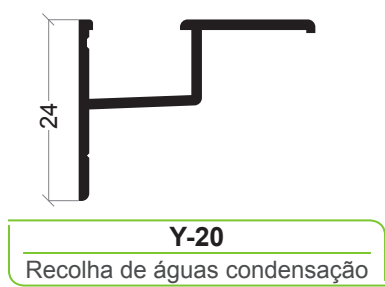

Y-20
Recolha de águas condensação

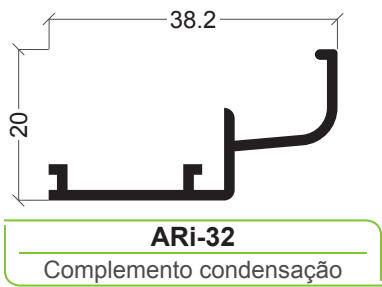

ARi-32
Complemento condensação

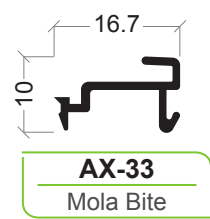

AX-33
Mola Bite

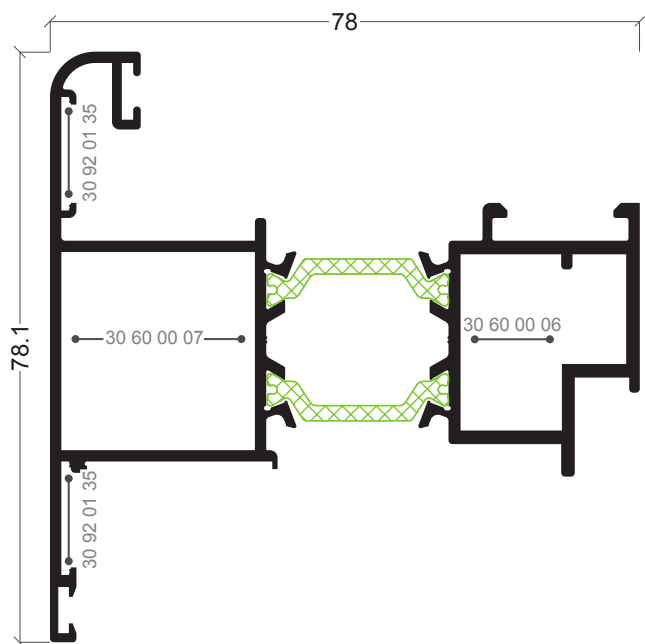

AJi-07
Aro móvel projectante

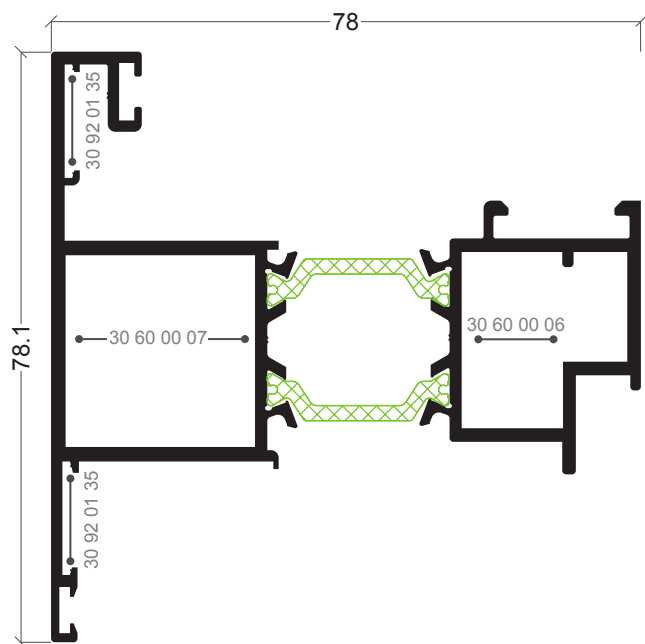

AJi-95
Aro móvel projectante

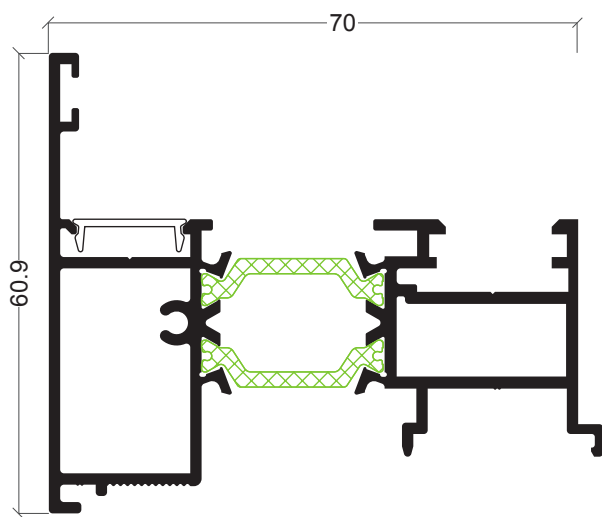

AJi-04
Inversor

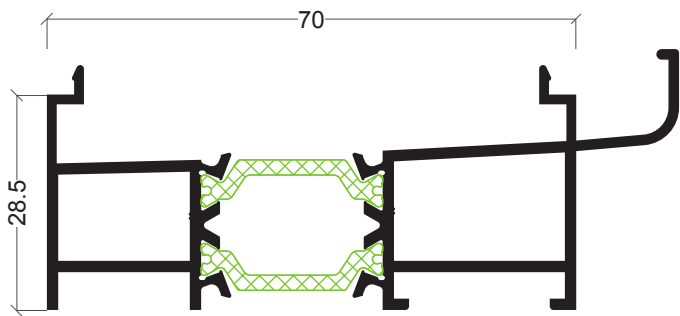

AJi-71
Soleira condensação



AXi-32
Complemento projectante



AXi-31
Guia projectante

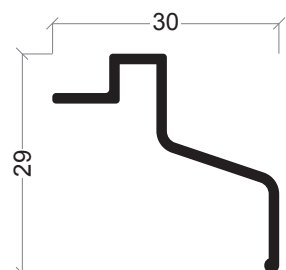

AXi-45
Pingadeira projectante

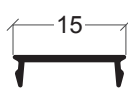

KL-04
Tampa



AX-19
Vareta

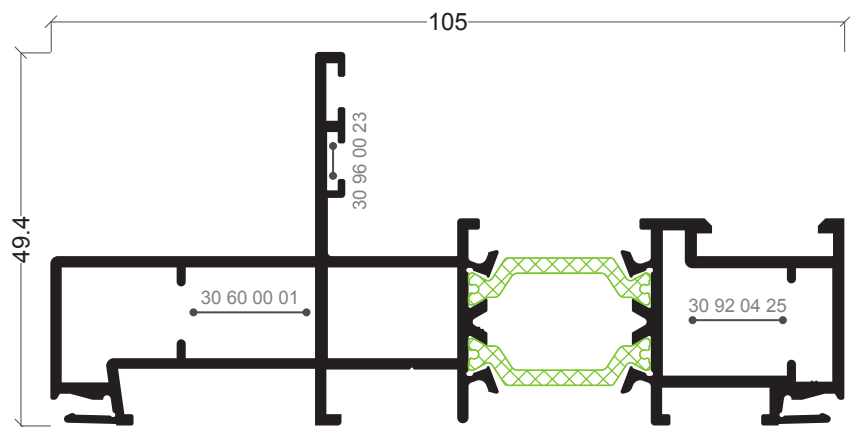

AJi-20
Perfil ligação CW

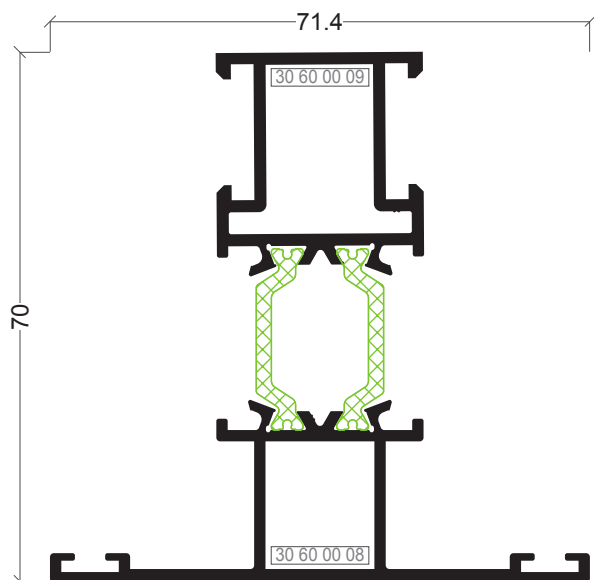

AJi-01
Travessa

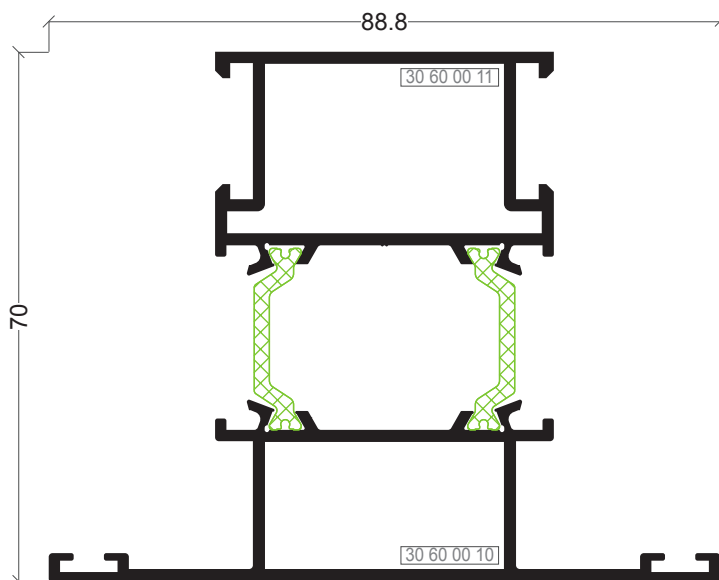

AJi-06
Travessa

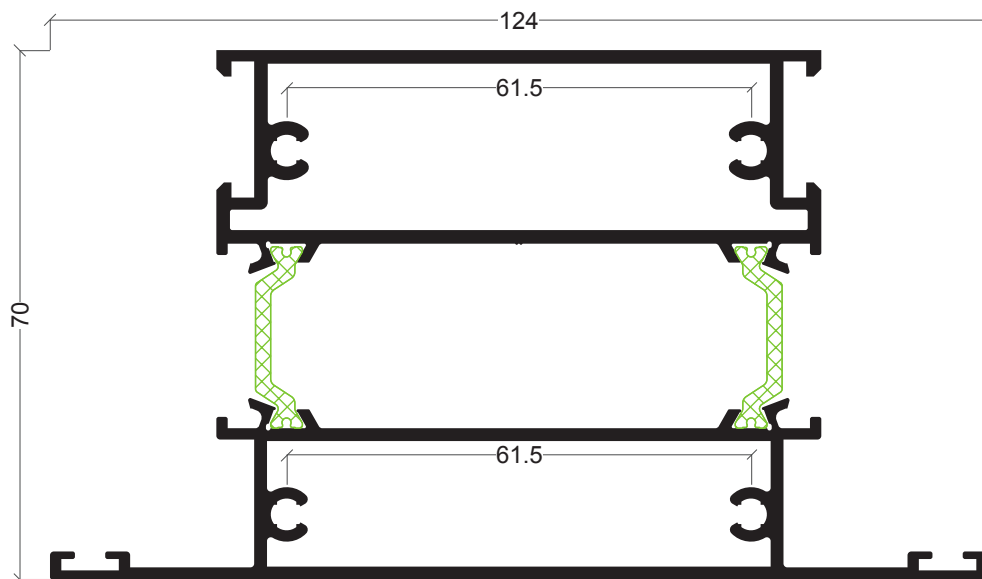

AJi-12
Travessa

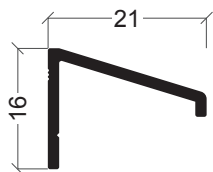

A1-46
Pingadeira janela

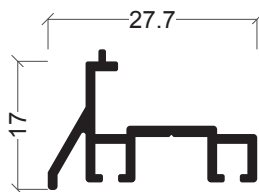

AJi-62
Pingadeira inferior porta sacada

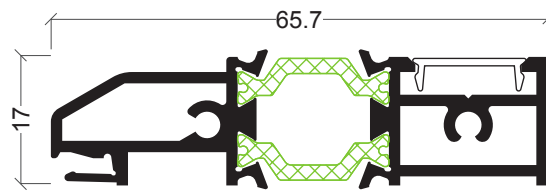

AJi-63
Remate inferior porta

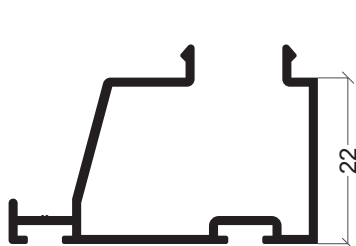

AJi-82
Bite remate

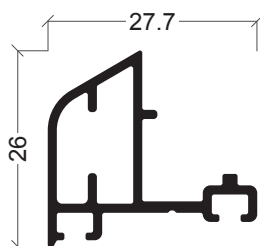

AZ-79
Pingadeira inferior de porta

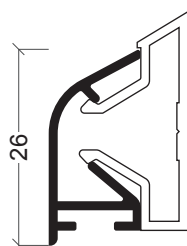

AZ-60
Pingadeira

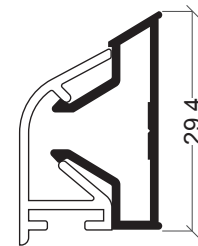

AZ-61
Clip pingadeira

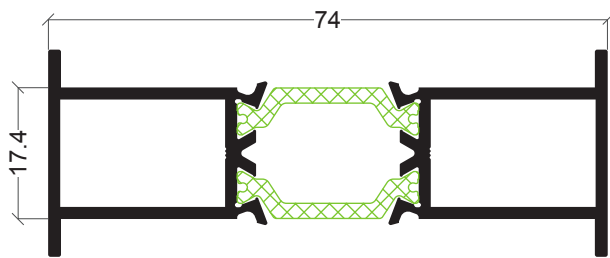

AJi-21
União de aros

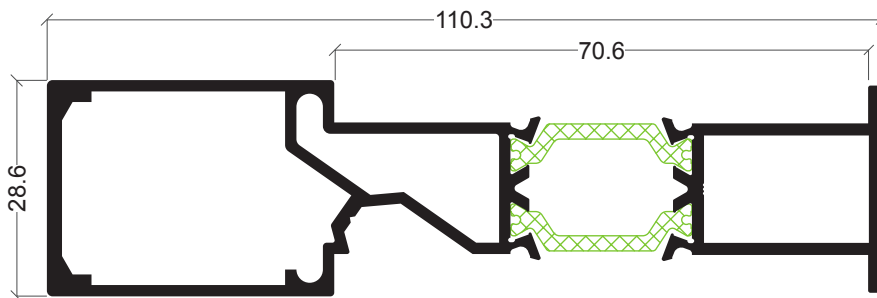

AJi-65
União de aros

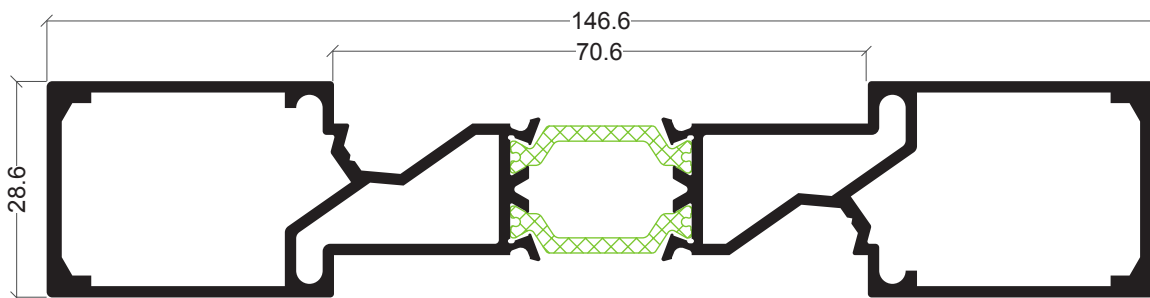

AJi-67
União de aros

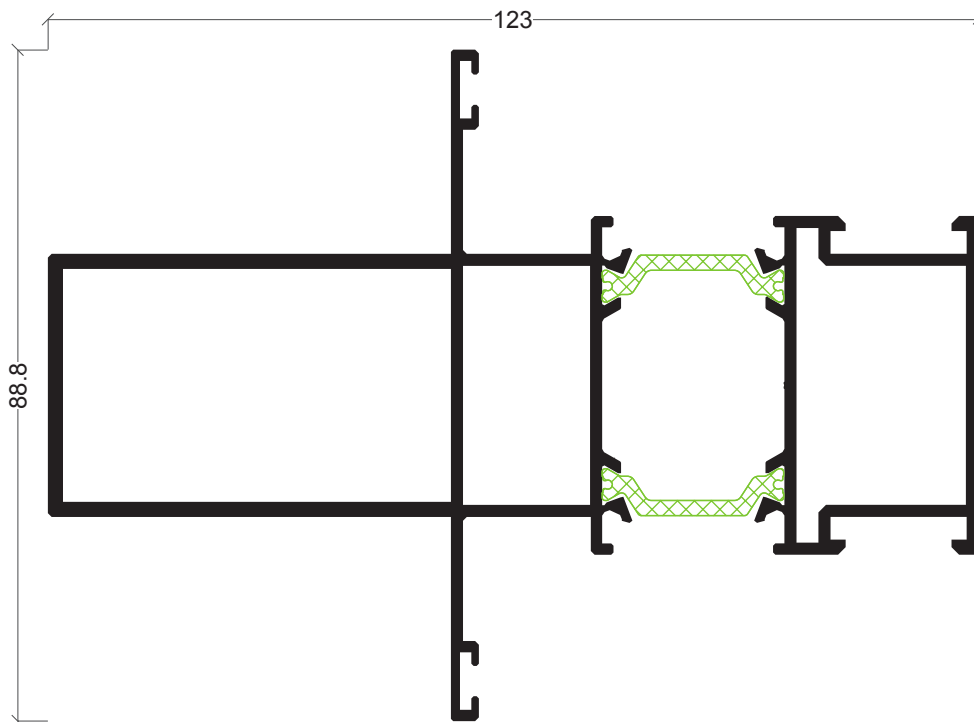

AJi-79
Montante recto

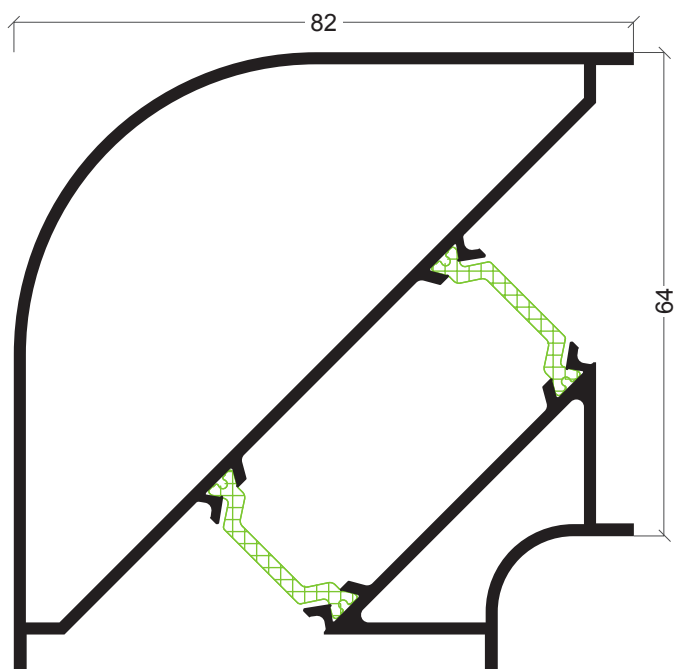

ARI-16
Esquina 90°

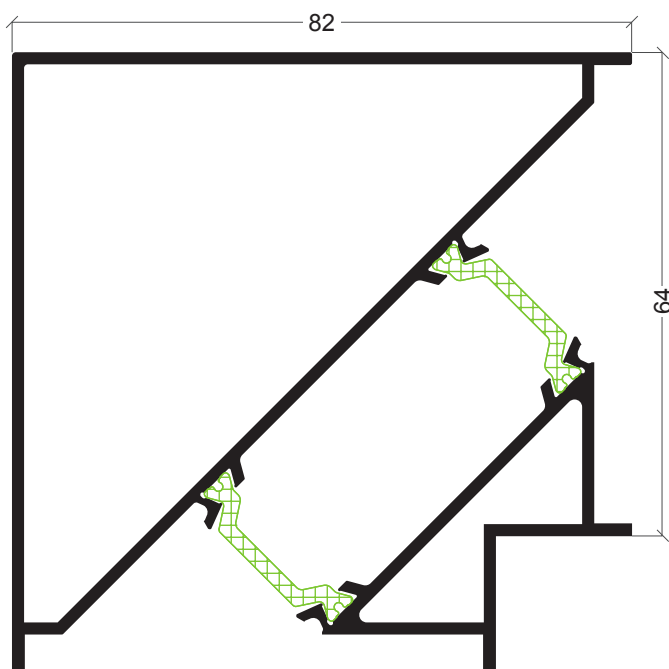

ARI-64
Esquina 90°

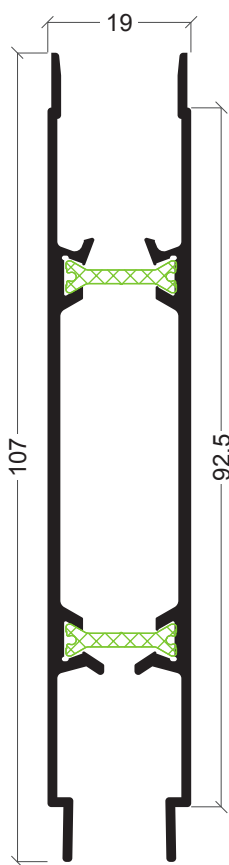

W-15

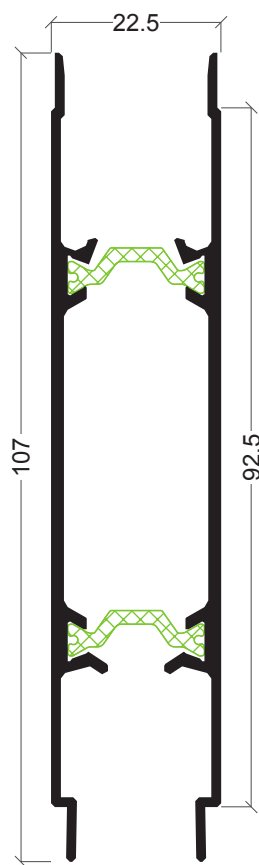

W-18

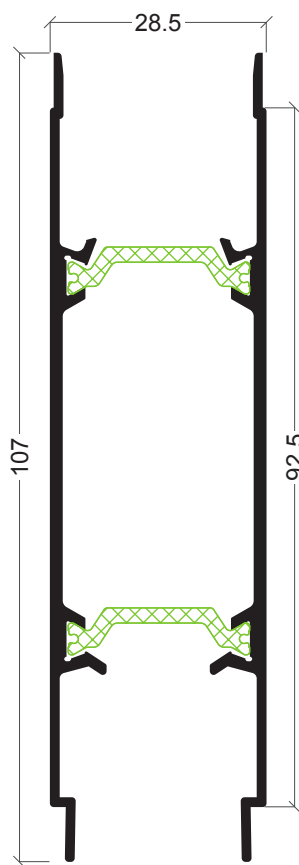

W-20

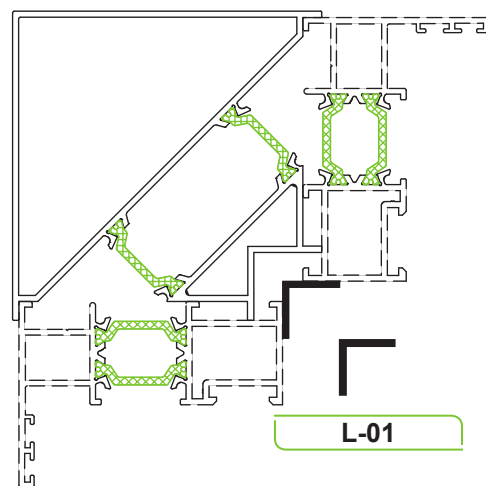

L-01

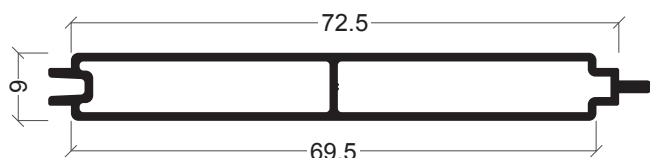

W-23
Régua tapa-luz

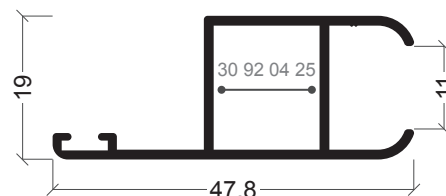

AZ-22
Tapa-luz

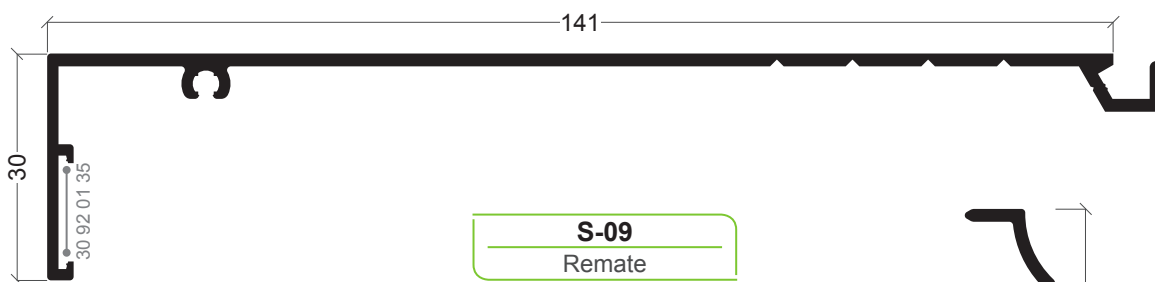

S-09
Remate

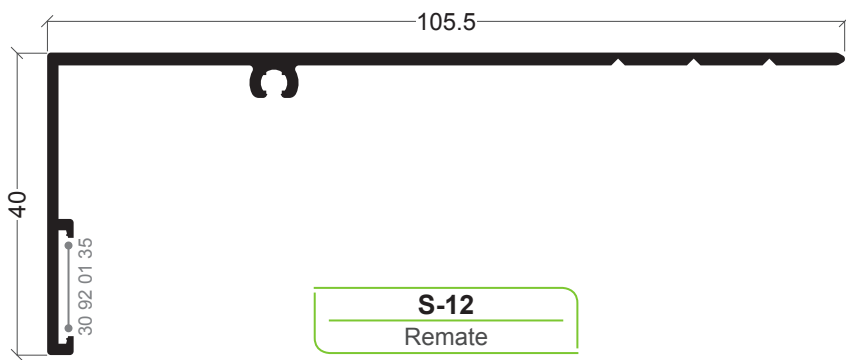

S-12
Remate

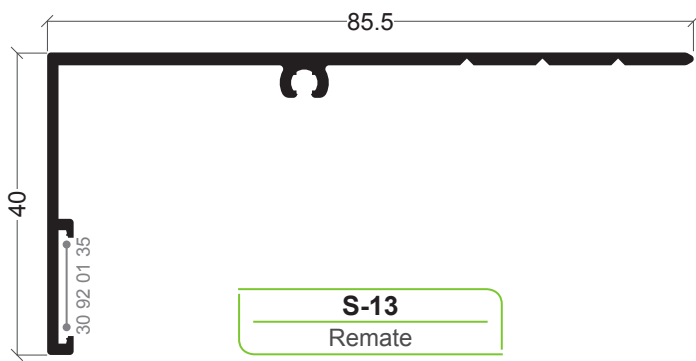

S-13
Remate

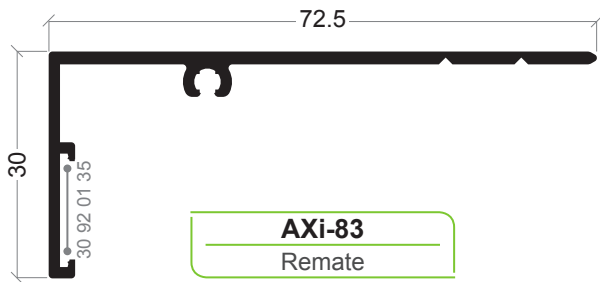

AXi-83
Remate

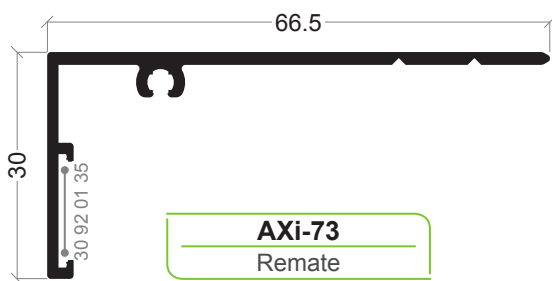

AXi-73
Remate

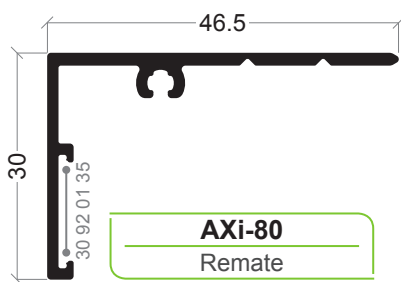

AXi-80
Remate

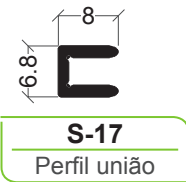

S-17
Perfil união

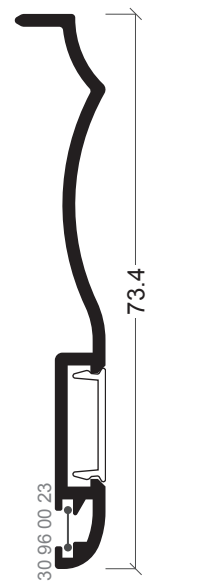

S-18
Remate



S-14
Remate

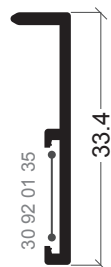

AXi-88
Complemento remate



AXi-91
Complemento remate

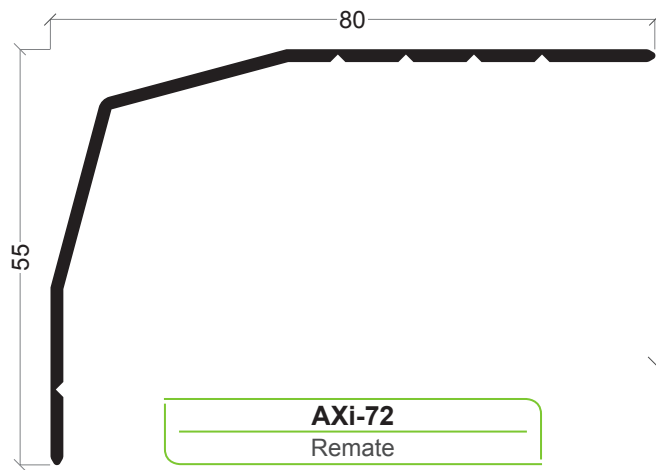

AXi-72
Remate

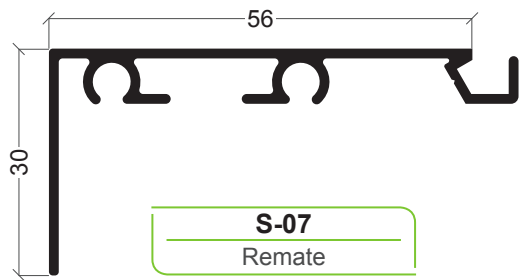

S-07
Remate

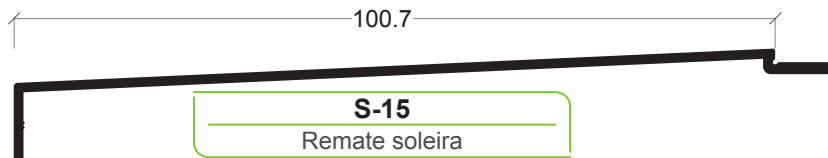

S-15
Remate soleira

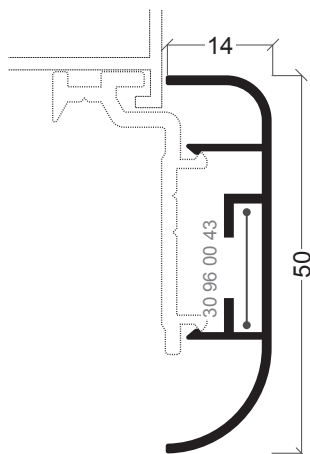

ARi-27
Tapa juntas

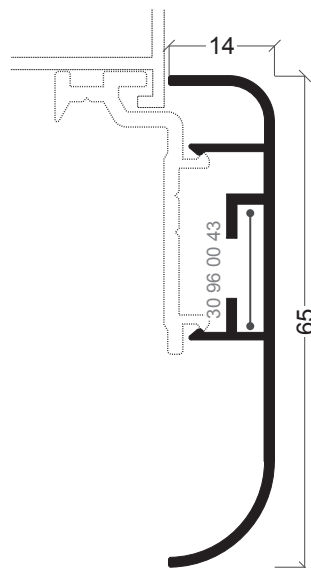

ARi-34
Tapa juntas

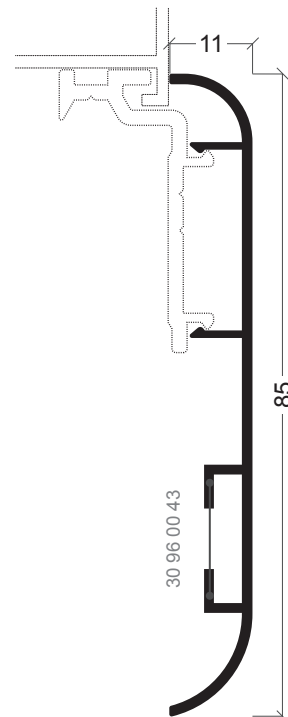

ARi-28
Tapa juntas

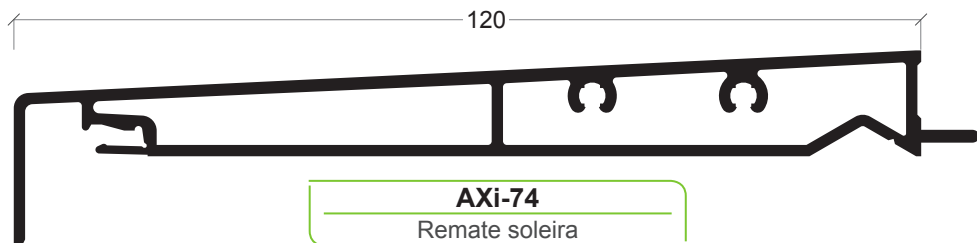

AXi-74
Remate soleira

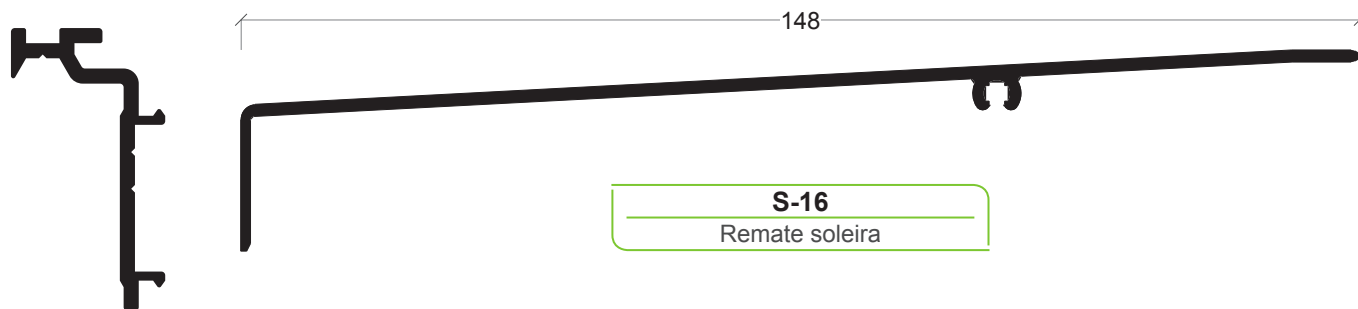

S-16
Remate soleira

ARi-26
Mola tapa juntas



ARi-24
Mola tapa juntas

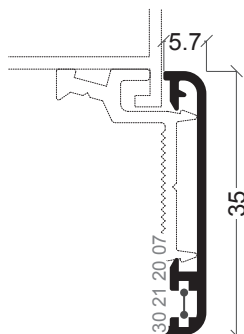

ARi-30
Tapa juntas

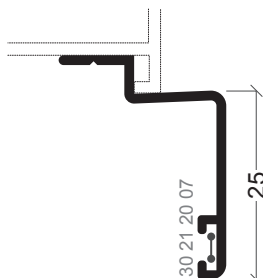

ARi-66
Tapa juntas

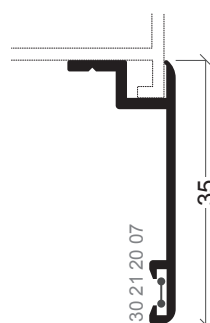

ARi-31
Tapa juntas

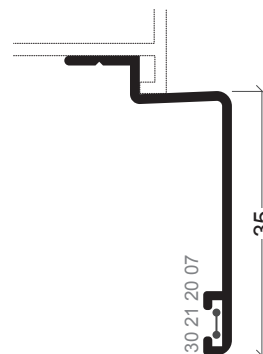

ARi-37
Tapa juntas

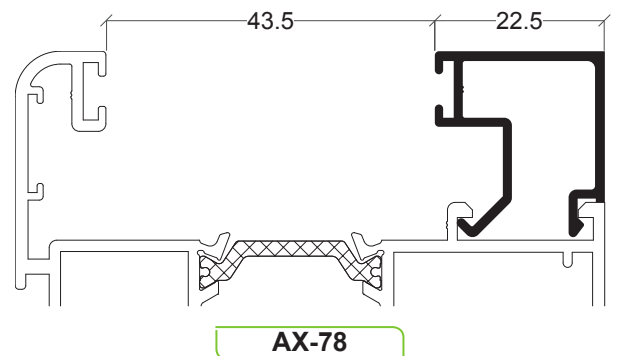
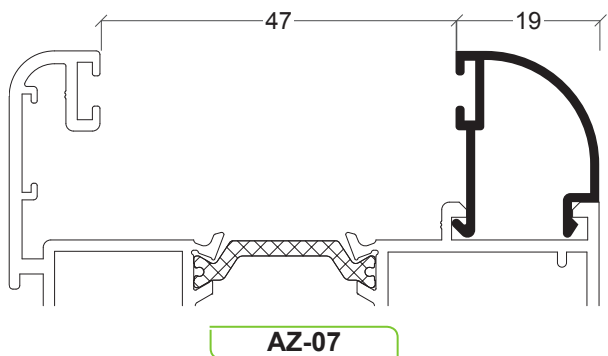
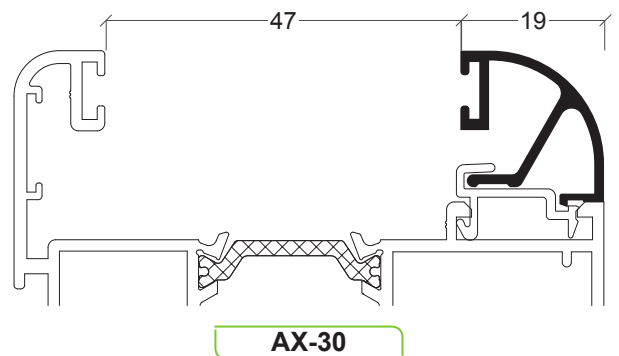
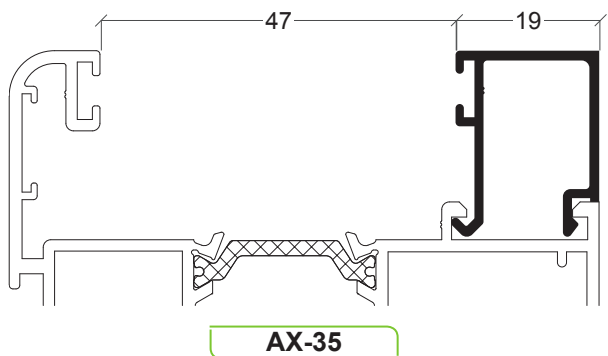
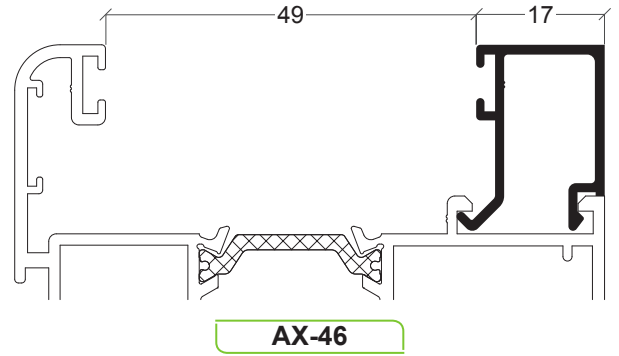
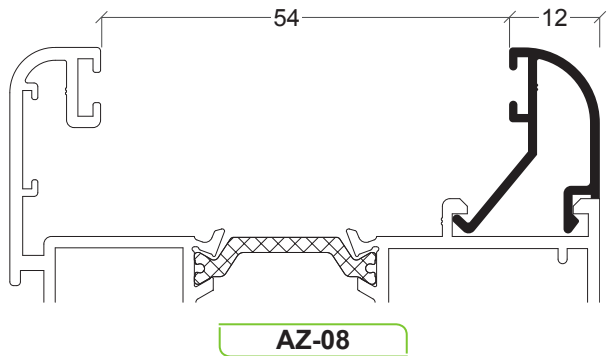
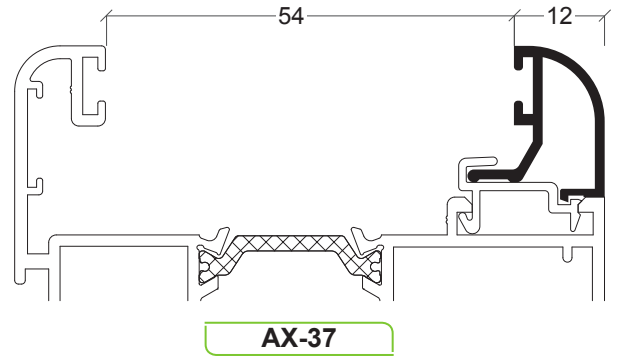
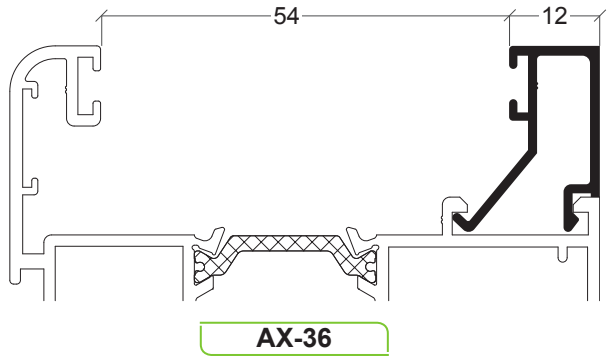
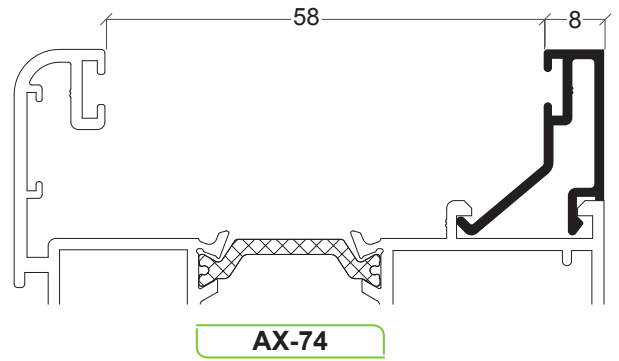
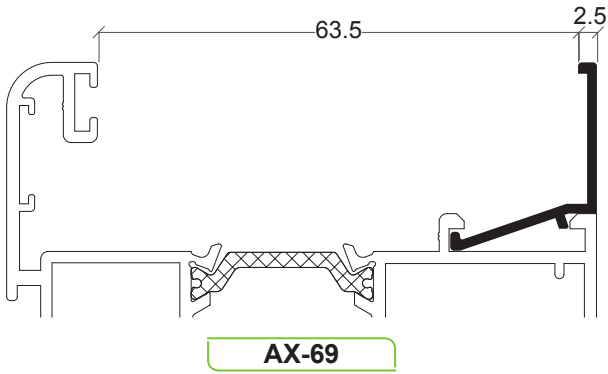

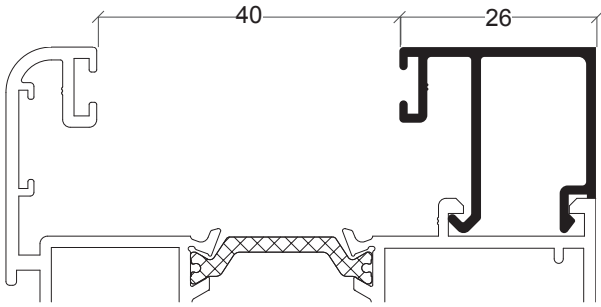

AX-31

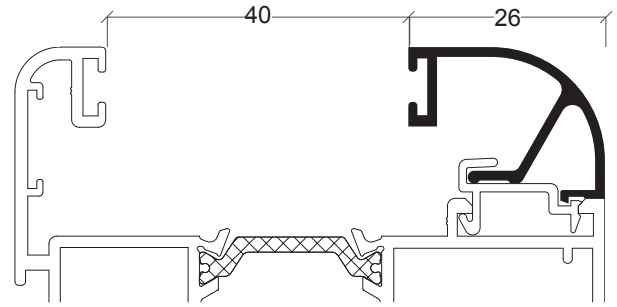

AX-29

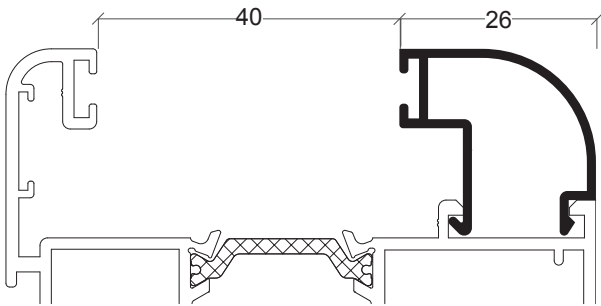

AZ-06

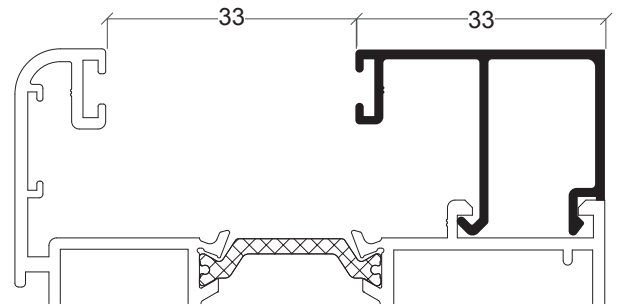

AX-34

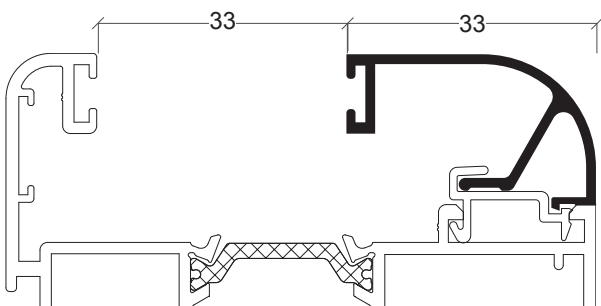

AX-39

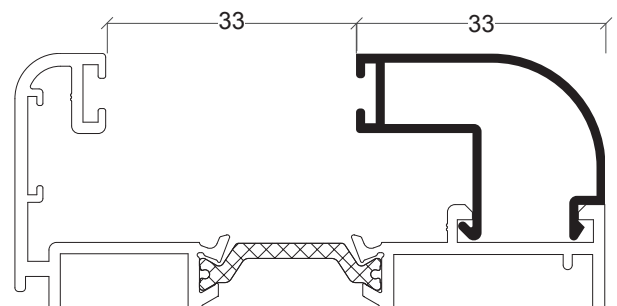

AZ-28

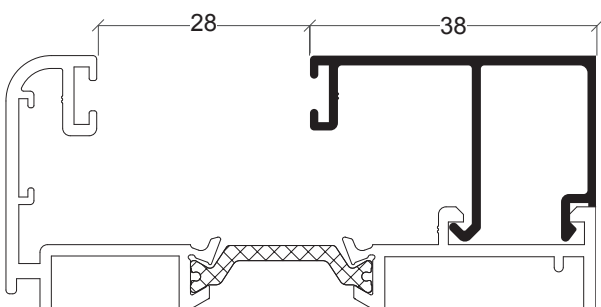

AX-32

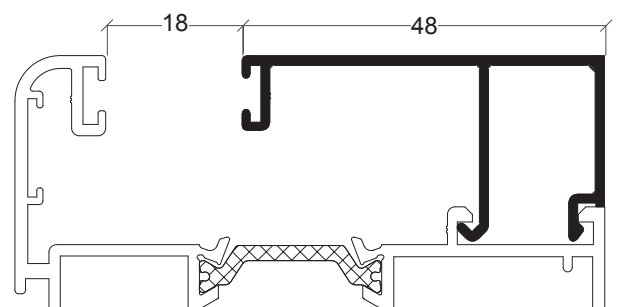

AX-80

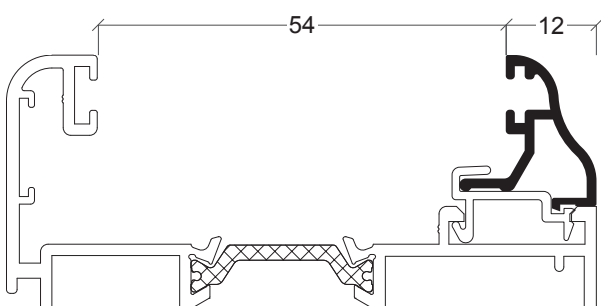

AX-72

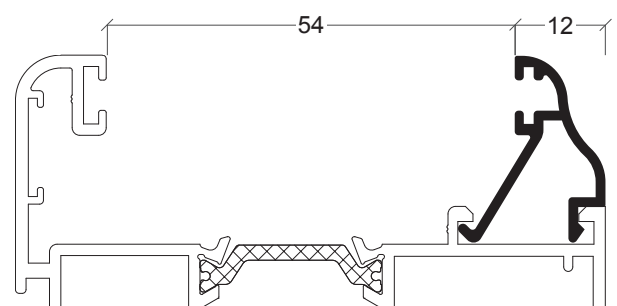

AX-73

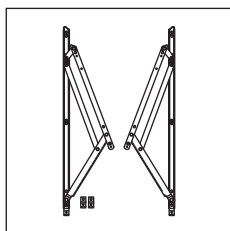

30 00 95 21
Jogo compasso (180 kg)

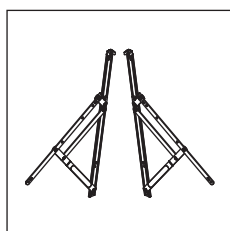

30 00 95 71
Jogo compasso (60 kg)

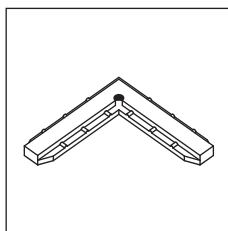

30 21 20 07
Esquadro de alinhamento

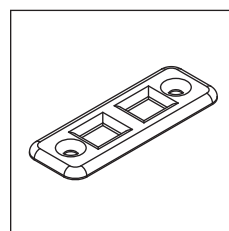

30 24 30 75
Contra-fecho inox

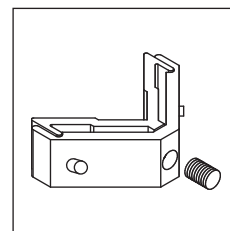

30 60 00 01
Esquadro exterior janela

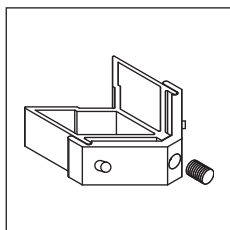

30 60 00 02
Esquadro exterior porta

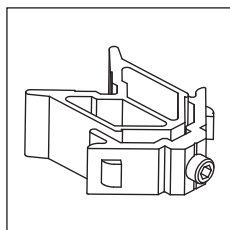

30 60 00 03
Esquadro interior porta com clip

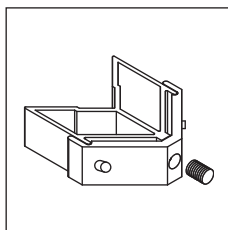

30 60 00 04
Esquadro exterior porta

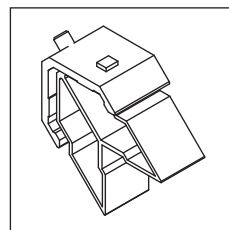

30 60 00 05
Esquadro interior porta

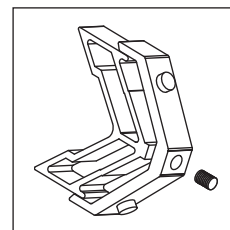

30 60 00 06
Esquadro interior projectante

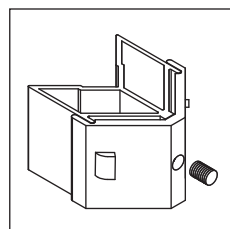

30 60 00 07
Esquadro exterior projectante

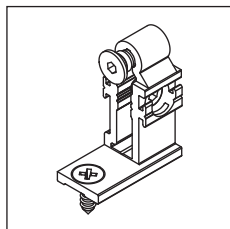

30 60 00 08
União travessa exterior pequena fixo

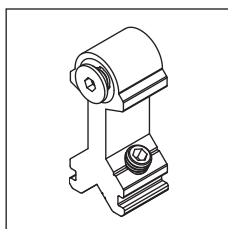

30 60 00 09
União travessa interior pequena

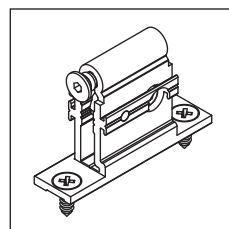

30 60 00 10
União travessa exterior grande fixo/móvel

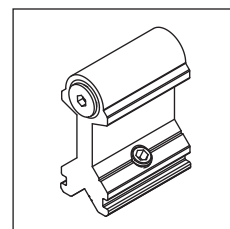

30 60 00 11
União travessa interior grande

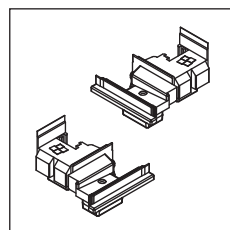

30 60 00 12
Conjunto topos inversor AJi

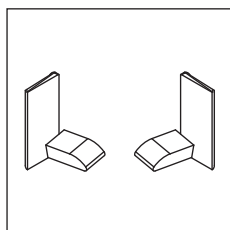

30 60 00 13
Conjunto topos AJi-62

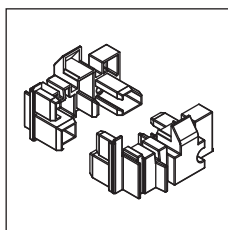

30 60 00 15
Conjunto topos AJi-63

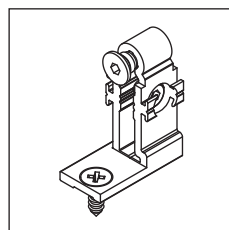

30 60 00 16
União travessa exterior pequena móvel

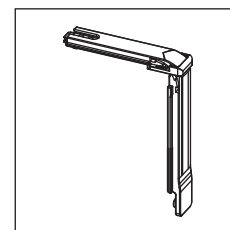

30 90 20 42
Ângulo de reenvio

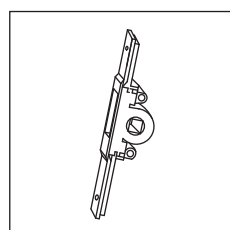

30 90 20 44
Transmissão para abertura exterior

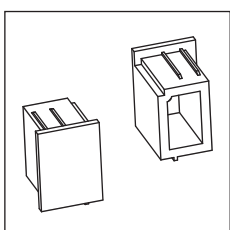

30 91 21 20
Jogo topos condensação Y-20

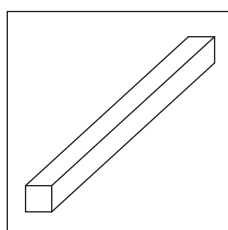

30 91 41 23
Perno 7 x 131 mm

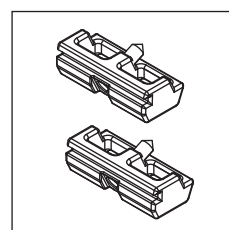

30 92 00 50
Complemento fecho

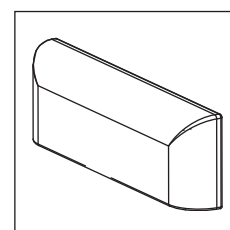

30 92 01 00/01
Goteira preto/branco

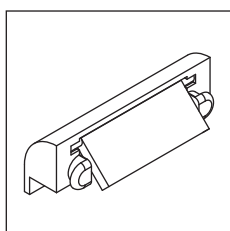

30 92 01 02/03
Goteira com válvula preto /branco

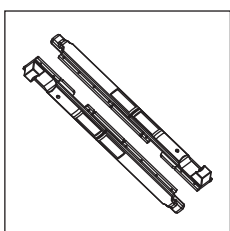

30 92 01 20
Jogo fecho C.E.



30 92 01 23
Jogo de passadores bidireccional C.E.

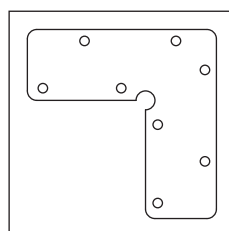

30 92 01 35
Esquadro de alinhamento

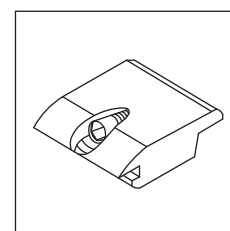

30 92 02 60
Apoio da folha

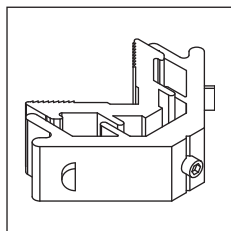

30 92 04 25

Esquadro interior janela fixo com clip

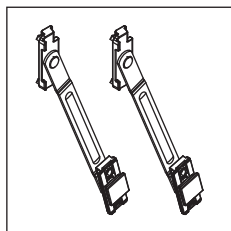

30 92 04 75

Jogo compassos basculante

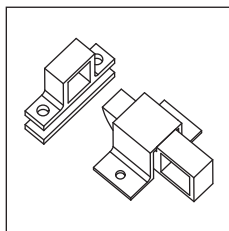

30 92 04 76/77

Fecho clack branco/preto

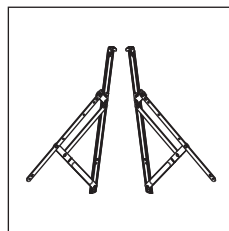

30 92 04 80

Compasso projectante deslizante até 50 kg / folha

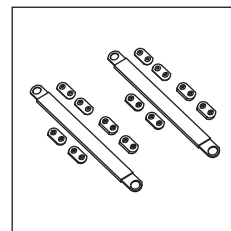

30 92 04 85

Jogo compassos

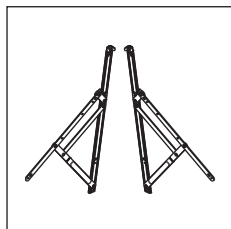

30 92 04 90

Compasso projectante deslizante até 70 kg / folha

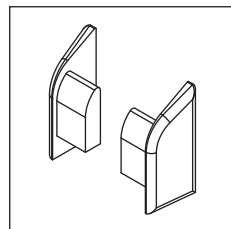

30 92 05 00

Jogo topos

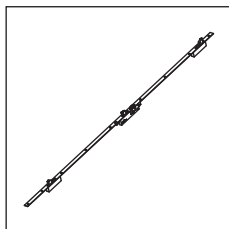

30 92 05 10

Fechadura 3 pontos (35 mm)

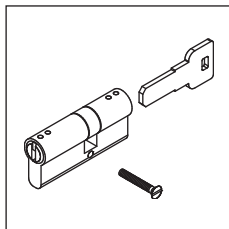

30 92 05 55

Canhão fechadura

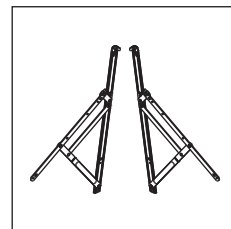

30 92 06 00

Compasso projectante deslizante até 20 kg / folha

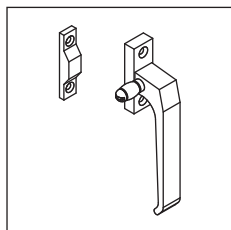

30 92 06 10/11

Cremona de lingueta branco/preto

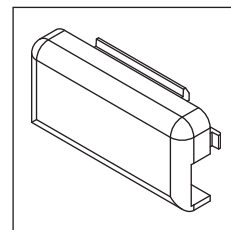

30 92 13 04

Goteira preta

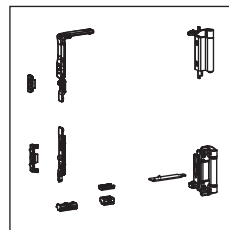

30 92 22 46/47

Kit OB sem cremone branco/preto

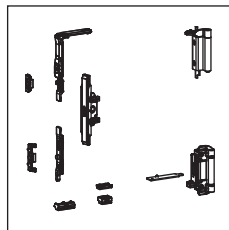

30 92 22 48/49

Kit OB com transmissão branco/preto sem puxador

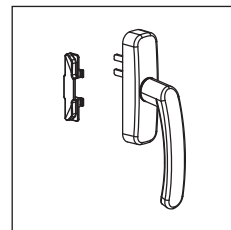

30 92 22 50/51

Cremona branco/preto

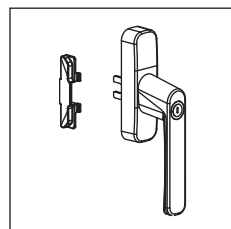

30 92 22 52/53

Cremona com chave branco/preto

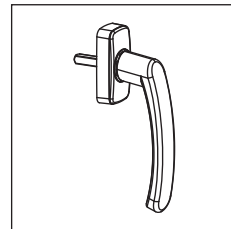

30 92 22 54/55

Puxador branco/preto

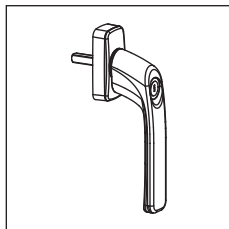

30 92 22 56/57

Puxador com chave branco/preto

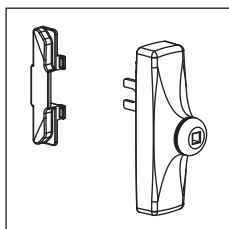

30 92 22 58/59

Cremona extraível branco/preto

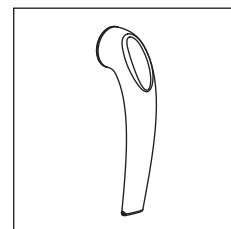

30 92 22 60/61

Punho extraível branco/preto

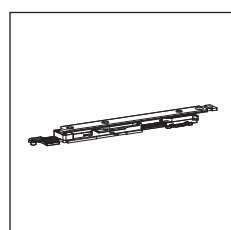

30 92 22 62

Compasso OB pequeno 340 - 441

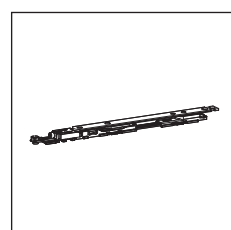

30 92 22 63

Compasso OB médio 442 - 750

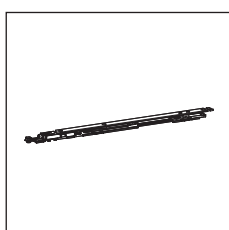

30 92 22 64

Compasso OB grande 751 - 1500

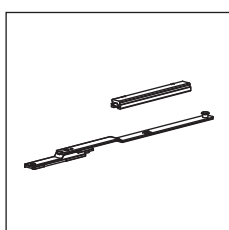

30 92 22 65

Compasso OB suplementar 1001 - 1500

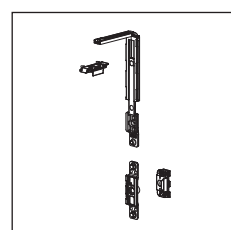

30 92 22 66

Kit 3º ponto OB

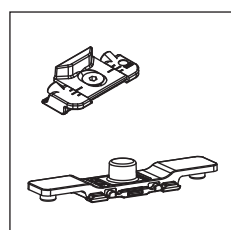

30 92 22 67

Ponto de fecho suplementar

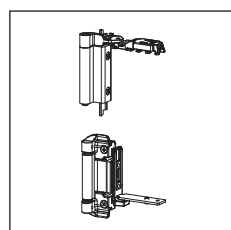

30 92 22 68/69

Kit dobradiça 2ª folha OB branco/preto

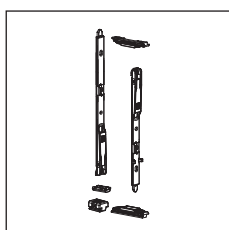

30 92 22 70

Kit fechos 2ª folha OB

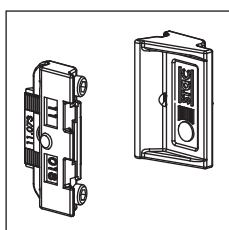

30 92 22 71

Conjunto ponto fecho suplementar folha passiva

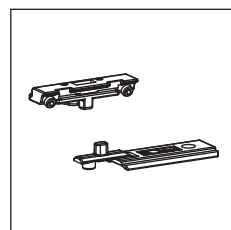

30 92 22 72

Conjunto micro-ventilação

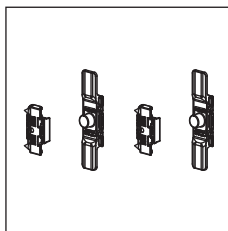

30 92 22 73

Kit batente 1 folha
Anírius S/ cremone

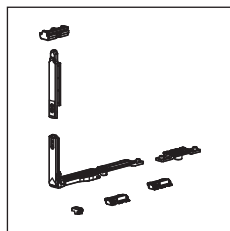

30 92 22 74

Kit batente 2 folhas
Anírius S/ cremone

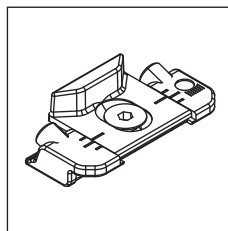

30 92 22 75

Ponto de fecho regulável
(H > 1100 mm)

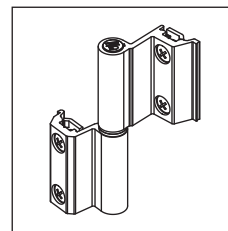

30 92 22 76/77

Dobradiça com afinação
branco/preto

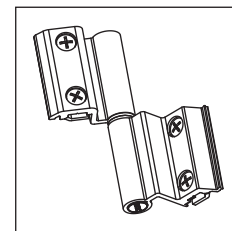

30 92 22 78/79

Dobradiça com afinação
3ª folha branco/preto

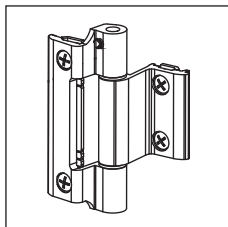

30 92 22 80/81

Dobradiça 3 nós
reversível branco/preto

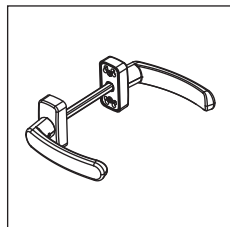

30 92 22 82/83

Puxador duplo branco/
preto

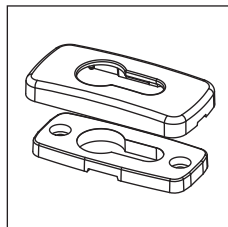

30 92 22 85/86

Escudo para canhão
branco/preto

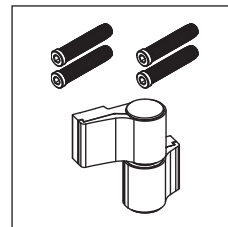

30 92 22 88/89

Dobradiça 2 abas porta c/ ressalto
fixação directa branco/preto

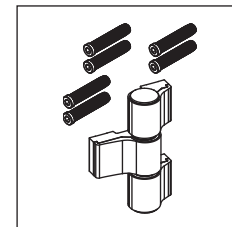

30 92 22 90/91

Dobradiça 3 abas porta c/ ressalto
fixação directa branco/preto

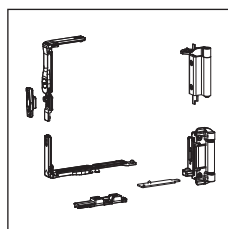

30 92 23 00/01

Kit oscilo-batente sem
cremone branco/preto

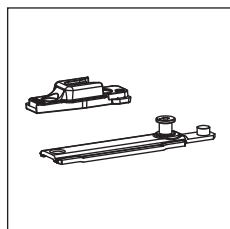

30 92 23 02

Conjunto ponto de fecho
terminal

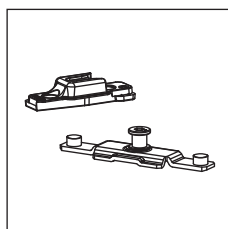

30 92 23 03

Conjunto ponto de fecho
intermédio



30 92 23 04

Kit ângulo de reenvio

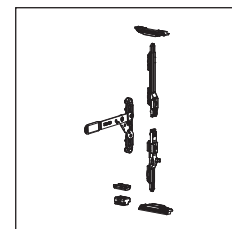

30 92 23 05

Jogo passadores OB
bidirecional

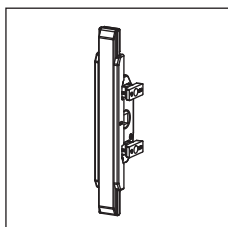

30 92 23 06

Transmissão

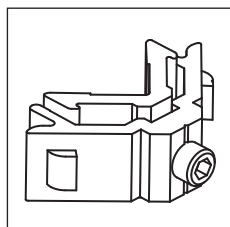

30 96 00 04

Esquadro interior janela

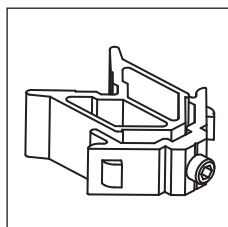

30 96 00 05

Esquadro interior aro fixo
porta

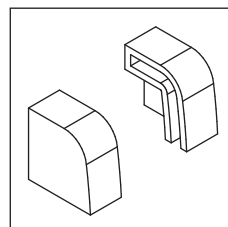

30 96 00 12

Jogo topos condensação

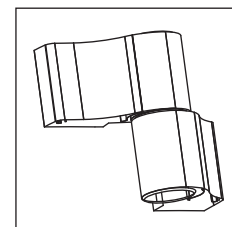

30 96 00 17/21

Dobradiça com ressalto
branco/preto

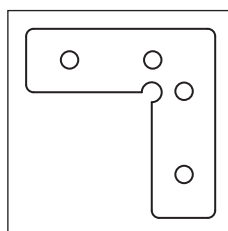

30 96 00 22

Esquadro alinhamento

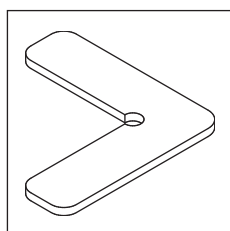

30 96 00 23

Esquadro alinhamento
aro fixo

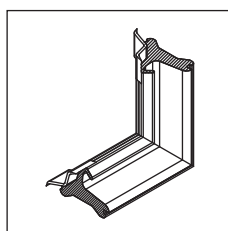

30 96 00 35

Canto vulcanizado

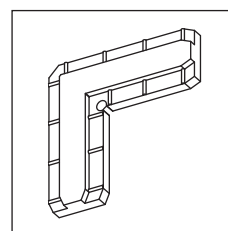

30 96 00 43

Esquadro alinhamento

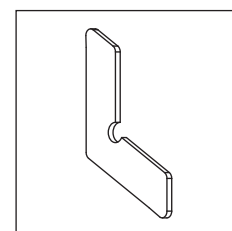

30 96 00 63

Esquadro alinhamento

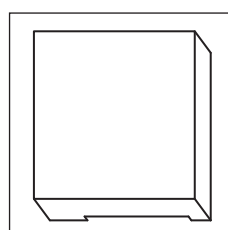

30 96 10 01

Calço para vidro aro
móvel

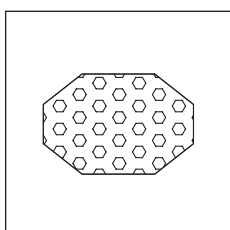

30 99 00 03

ThermoProfile ISO-03

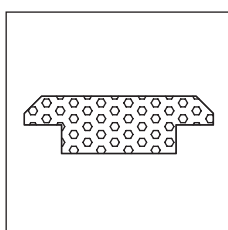

30 99 00 04

ThermoProfile ISO-04

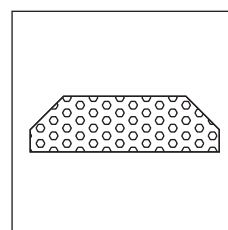

30 99 00 05

ThermoProfile ISO-05

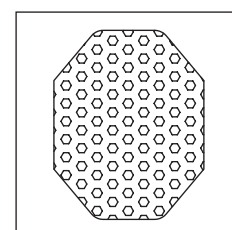

30 99 00 08

ThermoProfile ISO-08

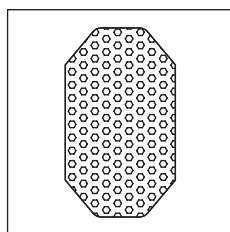
30 99 00 12

ThermoProfile ISO-12

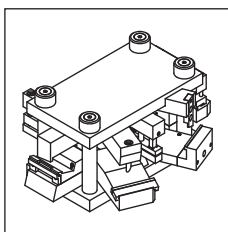
33 98 11 99



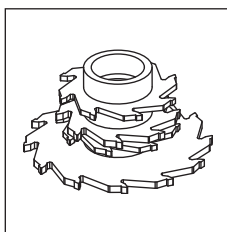



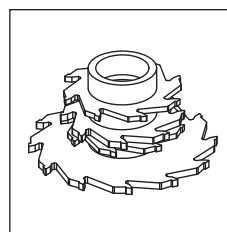













Cunho AJi





33 98 31 99

Conjunto de frezas fixo

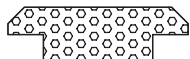

33 98 32 99

Conjunto de frezas móvel

Referência	Desenho	Descrição
30 00 95 15		Junta de vedação curta AZ-79
30 60 00 14		Perfil pelúcia metálica 18 mm preto
30 60 00 17		Junta exterior vidro plana 2 mm preto
30 60 00 18		Junta Isolante
30 92 04 70		Espuma isolante
30 93 00 60		Junta exterior do vidro (4 mm) preto
30 93 00 61		Junta de vedação exterior (2 mm) preto
30 93 00 62		Junta exterior plana para vidro (4 mm) preto
30 93 00 65		Junta interior para vidro (5 mm) preto
30 93 00 66		Junta interior para vidro (4 mm) preto
30 93 00 67		Junta interior para vidro (2 mm) preto
30 93 00 68		Junta interior para vidro (6/7 mm) preto
30 93 00 69		Junta interior para vidro (8/9 mm) preto
30 93 00 82		Junta vedação inferior AZ-79
30 93 01 20		Junta interior
30 94 01 46		Junta para veda-luz AZ-22
30 95 00 10		Pelúcia 7x9 mm
30 96 00 03		Junta central
30 96 00 09		Junta tapa-canal aro fixo
30 96 00 18		Junta interior (abertura projectante/deslizante)

Referência	ThermoProfile (Baguetes de 70 cm)	Aplicação
30 99 00 03		AJi-01; AJi-03; AJi-04; AJi-05; AJi-07; AJi-20; AJi-21; AJi-33; AJi-35; AJi-61; AJi-65; AJi-67; AJi-71; AJi-73; AJi-74; AJi-75; AJi-76; AJi-80; AJi-81; AJi-83; AJi-86; AJi-87; AJi-88; AJi-89; AJi-91; AJi-95
30 99 00 04		AJi-01; AJi-03; AJi-06; AJi-08; AJi-12; AJi-20; AJi-33; AJi-35; AJi-68; AJi-73; AJi-74; AJi-75; AJi-76; AJi-79; AJi-80; AJi-81; AJi-86; AJi-87; AJi-88; AJi-89; AJi-91; AJi-92; AJi-93; AJi-94
30 99 00 05		AJi-05; AJi-07; AJi-10; AJi-36; AJi-61; AJi-72; AJi-83; AJi-84; AJi-85; AJi-90; AJi-95
30 99 00 08		AJi-06; AJi-08; AJi-68; AJi-79; AJi-92; AJi-93; AJi-94
30 99 00 12		AJi-10; AJi-16; AJi-36; AJi-64; AJi-72; AJi-84; AJi-85; AJi-90

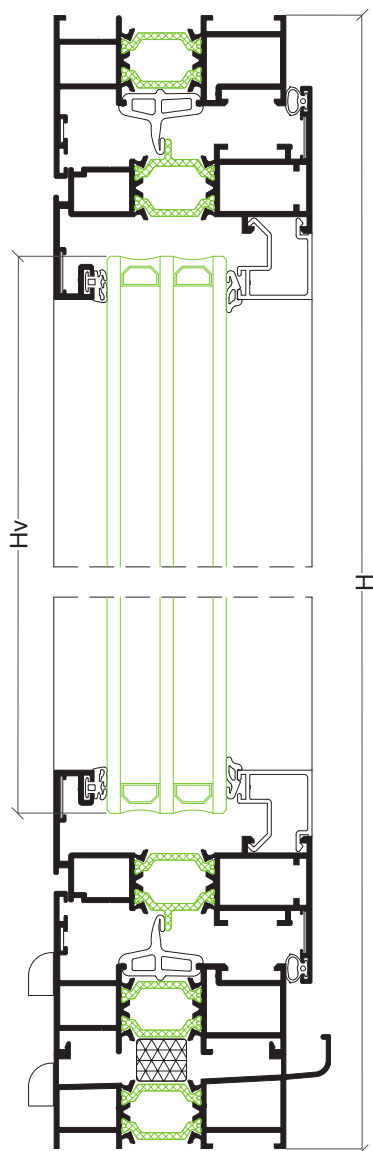
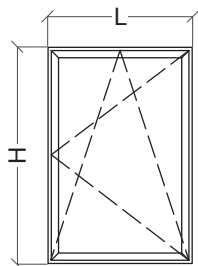
Janela 1 folha abrir e oscilo-batente



Perfis

Desenho	Ref	Descrição	Corte	Quant	Medida
	AJi-03	Aro fixo		2	L
				2	H-28.5 mm
	AJi-61	Aro móvel		2	L-43 mm
				2	H-71.5 mm
	---	Bite		2	L-132 mm
				2	H-200.5 mm
	AX-19	Vareta		várias	---
	AJi-71	Soleira		1	L

Acessórios e Juntas

Referência	Descrição	Quantidade	
		Abrir	Oscilo-batente
30 96 00 04	Esquadro interior		8
30 60 00 01	Esquadro exterior		8
30 96 00 23	Esquadro alinhamento fixo		4
30 96 00 22	Esquadro alinhamento móvel		8
30 96 10 01	Calço para vidro	4	6
30 92 22 (XX)	Cremone		1
---	Ferragem oscilo-batente (ver páginas 27/28)	---	1
30 92 22 73	Kit batente 1 folha sem cremone	1	---
30 92 22 76/77	Dobradiça com afinação branco/preto	2 ou mais	---
30 92 22 75	Ponto de fecho regulável (H > 1100 mm)	1	---
30 92 02 60	Apoio da folha	1	---
30 92 01 02	Goteira com válvula preto		4 ou mais
30 96 00 12	Jogo topos condensação		1
30 92 04 70	Espuma isolante		L
30 93 01 20	Junta interior		2L+2H
30 96 00 03	Junta central		2L+2H
30 96 00 35	Canto vulcanizado		4
---	Junta para vidro (exterior)		2L+2H
---	Junta para vidro (interior)		2L+2H

Vidro

Hv = H-174 mm	Lv = L-146 mm
---------------	---------------

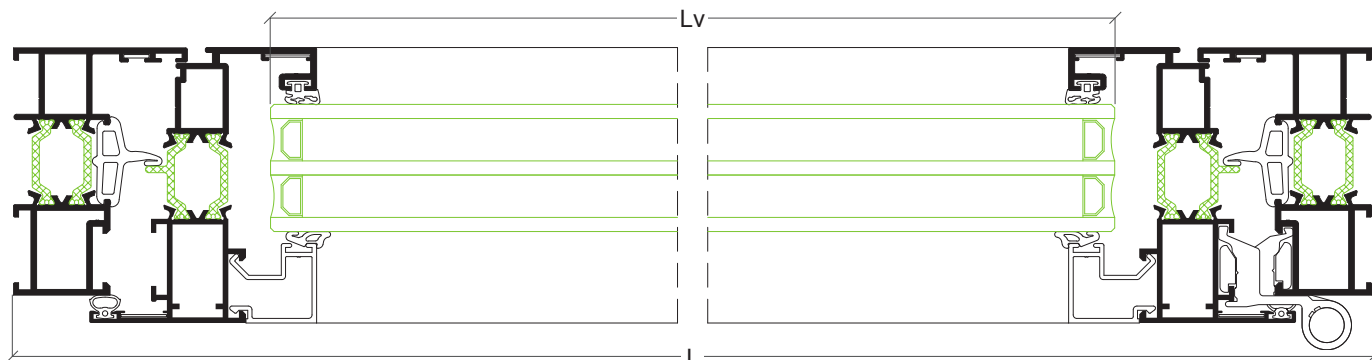

Janela 2 folhas abrir e oscilo-batente

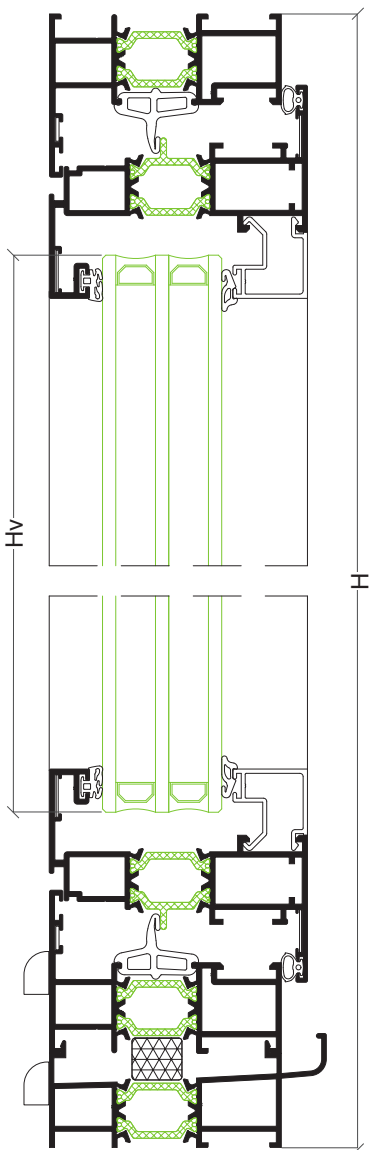
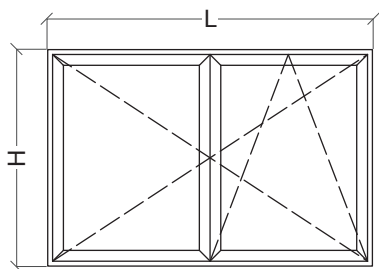

Perfis

Desenho	Ref	Descrição	Corte	Quant	Medida
	AJi-03	Aro fixo		2	L
				2	H-28.5 mm
	AJi-61	Aro móvel		2	L/2-24 mm
				2	H-71.5 mm
	---	Bite		4	L/2-113 mm
				4	H-200.5 mm
	AX-19	Vareta		várias	---
	AJi-04	Inversor		1	H-139.5 mm
	KL-04	Perfil tampa		1	H-139.5 mm
	AJi-71	Soleira		1	L

Acessórios e Juntas

Referência	Descrição	Quantidade	
		Abrir	Oscilo-batente
30 96 00 04	Esquadro interior		12
30 60 00 01	Esquadro exterior		12
30 96 00 23	Esquadro alinhamento fixo		4
30 96 00 22	Esquadro alinhamento móvel		16
30 96 10 01	Calço para vidro	8	12
30 92 22 (XX)	Cremona		1
---	Ferragem oscilo-batente (ver páginas 27/28)	---	1
30 92 22 74	Kit batente 2 folhas sem cremone	1	---
30 92 01 23	Jogo de passadores bidireccional C.E.	1	---
30 92 22 76/77	Dobradiça com afinação branco/preto	4 ou mais	---
30 92 22 75	Ponto de fecho regulável (H > 1100 mm)	1	---
30 92 02 60	Apoio da folha	1	---
30 92 01 02	Goteira com válvula preto		4 ou mais
30 60 00 12	Jogo topos inversor		1
30 96 00 12	Jogo topos condensação		1
30 92 04 70	Espuma isolante		L
30 93 01 20	Junta interior		2L+4H
30 96 00 03	Junta central		2L+3H
30 96 00 35	Canto vulcanizado		4
---	Junta para vidro (exterior)		2L+4H
---	Junta para vidro (interior)		2L+4H

Vidro

Hv = H-174 mm	Lv = L-127 mm
---------------	---------------

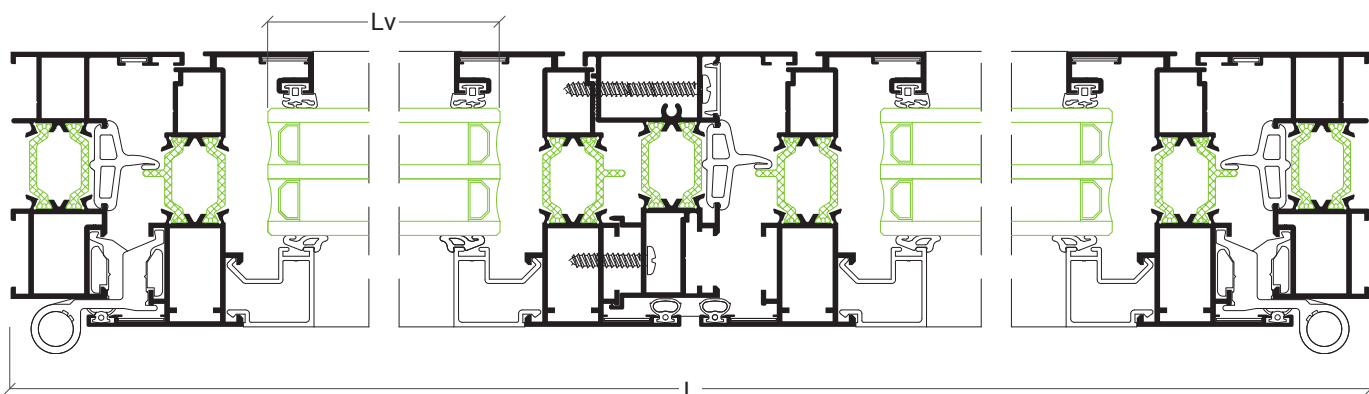

Janela projectante

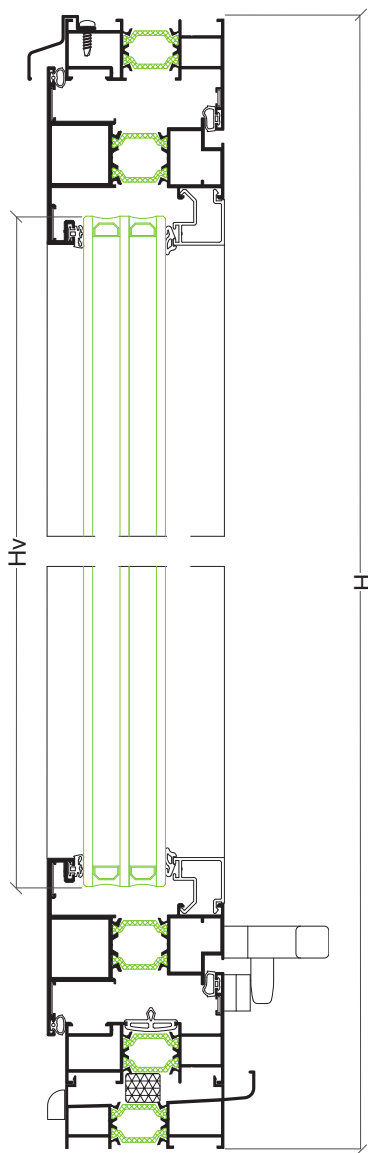
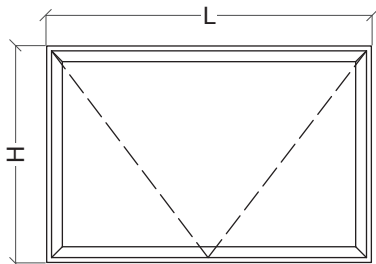

Perfis

Desenho	Ref	Descrição	Corte	Quant	Medida
	AJi-03	Aro fixo		2	L
				2	H-28.5 mm
	AJi-95	Aro móvel		2	L-43 mm
				2	H-71.5 mm
	---	Bite		2	L-159.5 mm
				2	H-228 mm
	AJi-71	Soleira		1	L
	AXi-45	Pingadeira		1	L
	AXi-32	Complemento		1	segundo medida do compasso

Acessórios e Juntas

Referência	Descrição	Quantidade
30 96 00 04	Esquadro interior	4
30 60 00 01	Esquadro exterior	4
30 96 00 23	Esquadro alinhamento fixo	4
30 92 01 35	Esquadro alinhamento móvel	8
30 96 00 06	Esquadro interior	4
30 96 00 07	Esquadro exterior	4
30 96 10 01	Calço para vidro	4
30 96 06 10 ou 11	Cremona de lingueta	2
---	Jogo compasso projectante	1
30 92 01 02	Goteira com válvula preto	2 ou mais
30 96 00 12	Jogo topos condensação	1
30 92 04 70	Espuma isolante	L
30 93 01 20	Junta exterior	2L+2H
30 96 00 18	Junta interior projectante deslizante	2L+2H
30 96 00 09	Junta tapa-canal	L
---	Junta para vidro (exterior)	2L+2H
---	Junta para vidro (interior)	2L+2H

Vidro

Hv = H-202 mm	Lv = L-173 mm
---------------	---------------

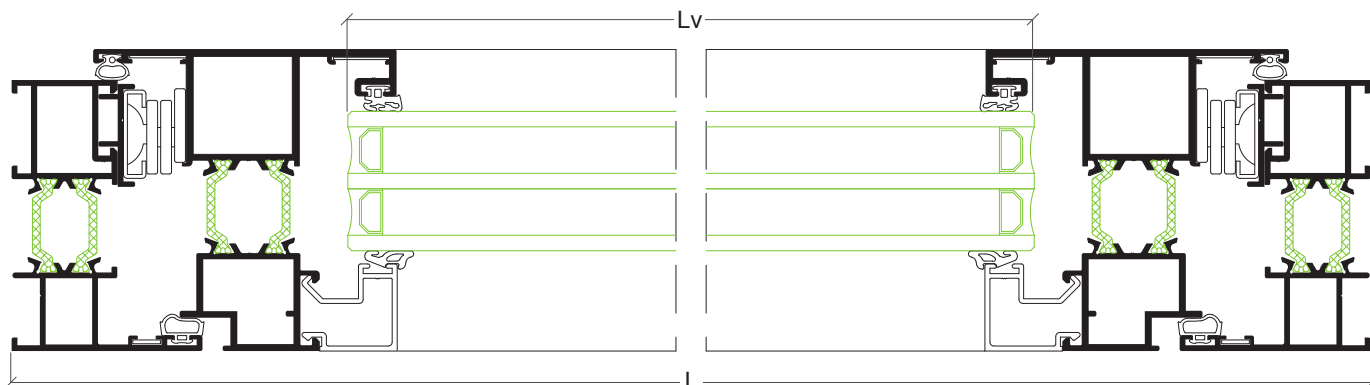

Porta 1 folha

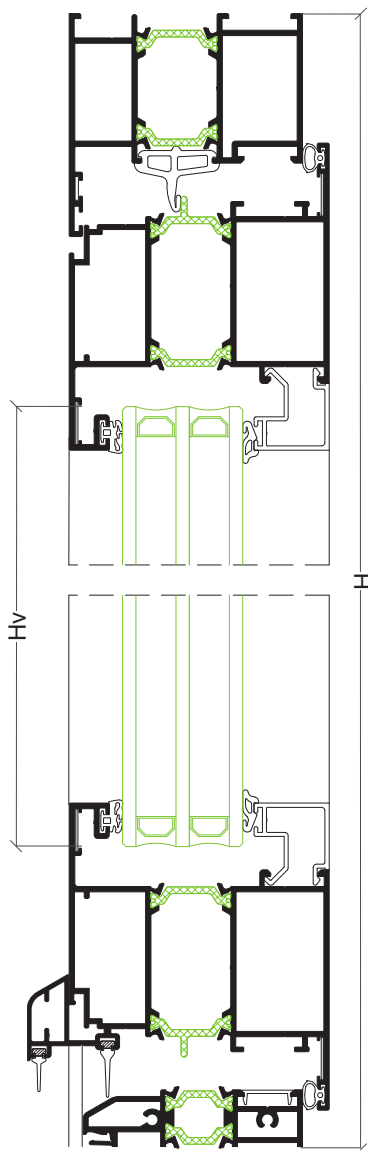
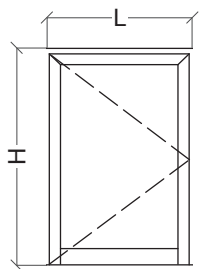

Perfis

Desenho	Ref	Descrição	Corte	Quant	Medida
	AJi-08	Aro fixo		1	L
				2	H
	AJi-36	Aro móvel		2	L-78 mm
				2	H-50 mm
	---	Bite		2	L-222 mm
				2	H-234 mm
	AJi-63	Remate inferior porta		1	L-80.5 mm
	AZ-79	Pingadeira		1	L-135 mm
	KL-04	Perfil tampa		1	L-90 mm

Acessórios e Juntas

Referência	Descrição	Quantidade
30 96 00 05	Esquadro interior	2
30 60 00 02	Esquadro exterior	2
30 60 00 05	Esquadro interior móvel	4
30 60 00 04	Esquadro exterior móvel	4
30 96 00 23	Esquadro alinhamento fixo	2
30 96 00 22	Esquadro alinhamento móvel	8
30 96 10 01	Calço para vidro	4
30 92 22 88 ou 89	Dobradiça 2 abas porta	2
30 92 05 10	Fechadura 3 pontos	1
30 92 22 82 ou 83	Puxador duplo	1
30 92 22 85 ou 86	Escudo para canhão	2
30 92 05 55	Canhão fechadura	1
30 93 01 20	Junta interior	2L+2H
30 96 00 03	Junta central	L+2H
30 96 00 35	Canto vulcanizado	2
30 92 05 00	Conjunto topos pingadeira	1
30 00 95 15	Junta inferior curta	L
30 93 00 82	Junta inferior	L
---	Junta para vidro (exterior)	2L+2H
---	Junta para vidro (interior)	2L+2H

Vidro

Hv = H-208 mm	Lv = L-236 mm
---------------	---------------

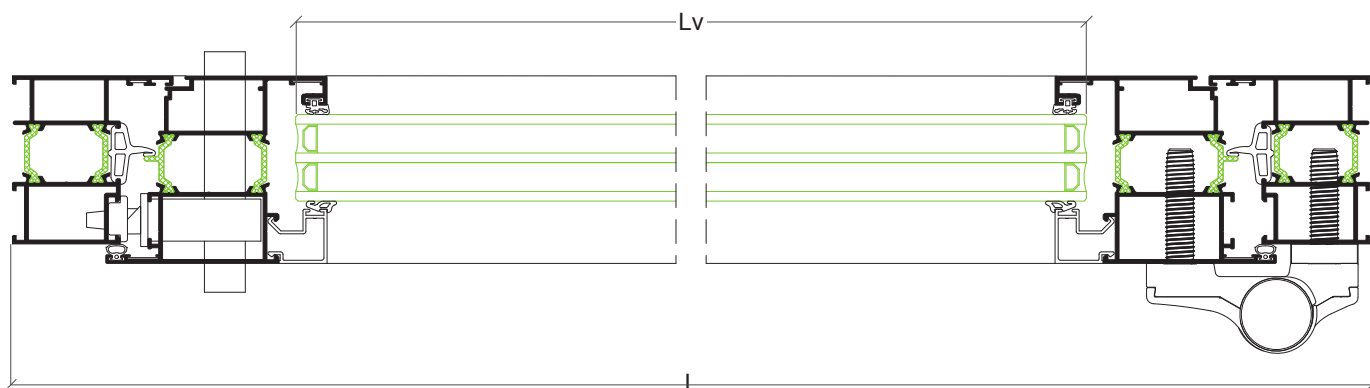

Porta 2 folhas

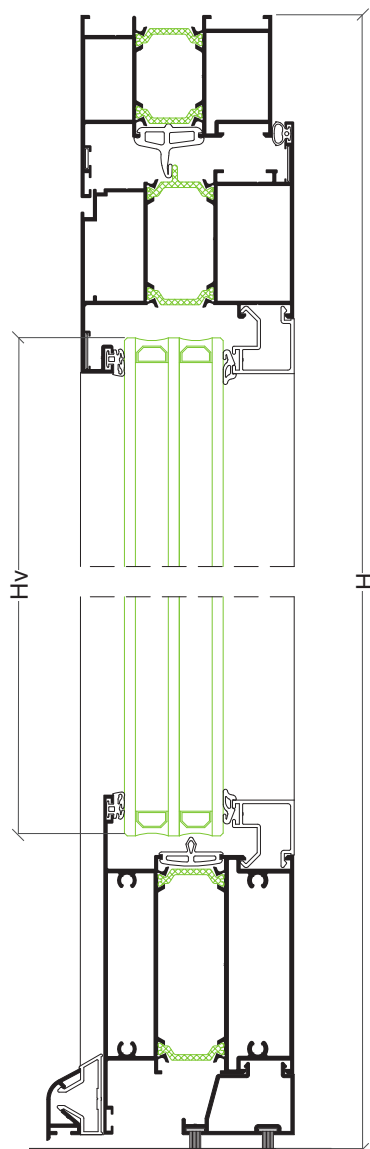
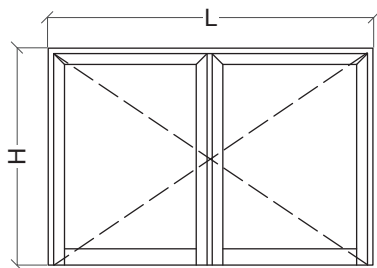

Perfis

Desenho	Ref	Descrição	Corte	Quant	Medida
	AJi-08	Aro fixo		1	L
				2	H
	AJi-36	Aro móvel		2	L/2-41.5 mm
				4	H-44 mm
	---	Bite		4	L/2-185.5 mm
				4	H-258 mm
	AJi-04	Inversor		1	H-78 mm
	KL-04	Perfil tampa		1	H-78 mm
	AJi-12	Travessa		2	L/2-176.5 mm
	AJi-82	Bite remate		2	L/2-185.5 mm
	AZ-60	Pingadeira		1	L/2-103 mm
				1	L/2-39 mm
	AZ-61	Suplemento pingadeira		2	L/2-226 mm

Acessórios e Juntas

Referência	Descrição	Quantidade
30 96 00 05	Esquadro interior	2
30 60 00 02	Esquadro exterior	2
30 60 00 05	Esquadro interior móvel	4
30 60 00 04	Esquadro exterior móvel	4
30 96 00 23	Esquadro alinhamento fixo	2
30 96 00 22	Esquadro alinhamento móvel	8
30 60 00 12	Jogo topos inversor	1
30 92 22 88 ou 89	Dobradiça 2 abas porta	4
30 92 05 10	Fechadura 3 pontos	1
30 92 22 82 ou 83	Puxador duplo	1
30 92 22 85 ou 86	Escudo para canhão	2
30 92 05 55	Canhão fechadura	1
30 92 00 50	Contra-fecho	1
30 24 30 75	Contra-fecho inferior	1
30 92 01 20	Jogo fecho C.E.	1
30 93 01 20	Junta interior	L+4H
30 96 00 03	Junta central	L+3H
30 96 00 35	Canto vulcanizado	2
30 92 05 00	Conjunto topos pingadeira	1
30 95 00 10	Pelúcia	2L
---	Junta para vidro (exterior)	2L+4H
---	Junta para vidro (interior)	2L+4H
30 96 00 09	Junta tapa-canal	2L

Vidro

Hv = H-232 mm	Lv = L/2-200 mm
---------------	-----------------

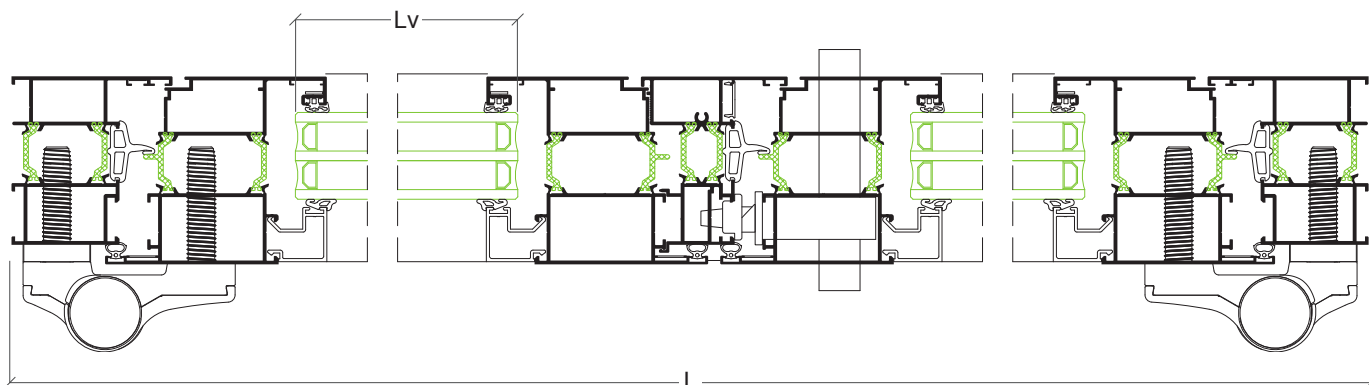

Porta 1 folha abertura exterior

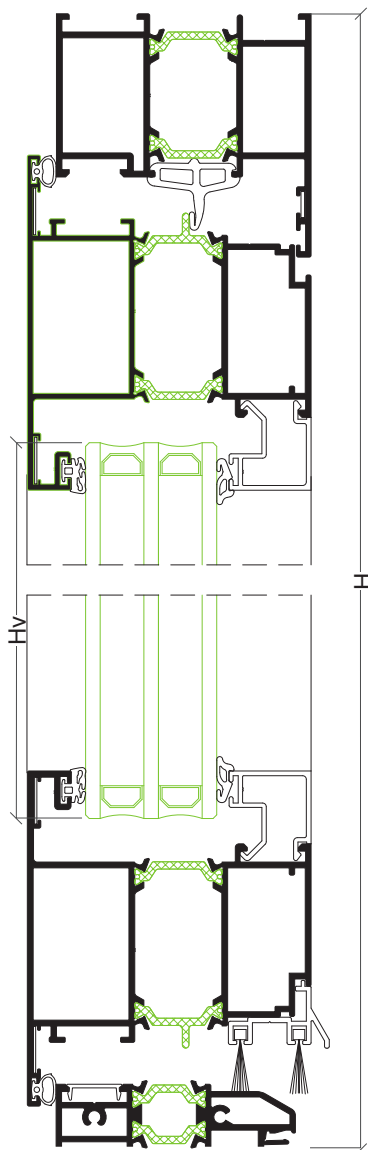
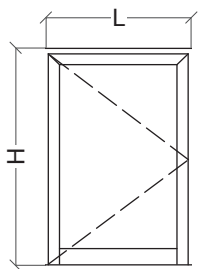

Perfis

Desenho	Ref	Descrição	Corte	Quant	Medida
	AJi-08	Aro fixo		1	L
				2	H
	AJi-72	Aro móvel		2	L-78 mm
				2	H-50 mm
	---	Bite		2	L-222 mm
				2	H-234 mm
	AJi-63	Remate inferior porta		1	L-80.5 mm
	AJi-62	Pingadeira		1	---
	KL-04	Perfil tampa		1	L-90 mm

Acessórios e Juntas

Referência	Descrição	Quantidade
30 96 00 05	Esquadro interior	2
30 60 00 02	Esquadro exterior	2
30 60 00 05	Esquadro interior móvel	4
30 60 00 04	Esquadro exterior móvel	4
30 96 00 23	Esquadro alinhamento fixo	2
30 96 00 22	Esquadro alinhamento móvel	8
30 96 10 01	Calço para vidro	4
30 92 22 88 ou 89	Dobradiça 2 abas porta	2
30 92 05 10	Fechadura 3 pontos	1
30 92 22 82 ou 83	Puxador duplo	1
30 92 22 85 ou 86	Escudo para canhão	2
30 92 05 55	Canhão fechadura	1
30 93 01 20	Junta interior	2L+2H
30 96 00 03	Junta central	L+2H
30 96 00 35	Canto vulcanizado	2
30 60 00 13	Conjunto topos AJi-62	1
30 60 00 14	Pelúcia preta 18 mm	2L
---	Junta para vidro (exterior)	2L+2H
---	Junta para vidro (interior)	2L+2H

Vidro

Hv = H-208 mm	Lv = L-236 mm
---------------	---------------

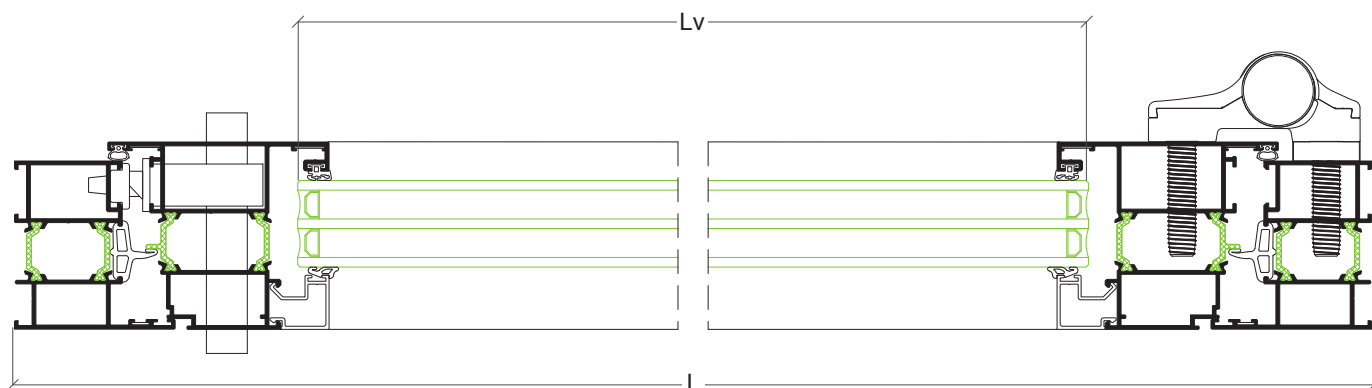

Ferragens para oscilo-batente

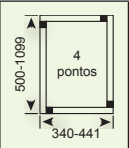
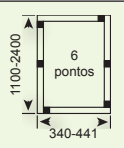
Designação	Referência		
Kit oscilo-batente	30 92 22 46 (branco) 30 92 22 47 (preto)	1	
Cremones	30 92 22 50 ou 51 ou 30 92 22 52 ou 53 ou 30 92 22 58 + 30 92 22 60 ou 30 92 22 59 + 30 92 22 61	1	
Compasso pequeno	30 92 22 62	1	
Kit fecho 3º ponto	30 92 22 66		1

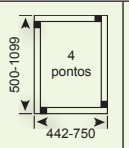
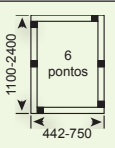
Designação	Referência		
Kit oscilo-batente	30 92 22 46 (branco) 30 92 22 47 (preto)	1	
Cremones	30 92 22 50 ou 51 ou 30 92 22 52 ou 53 ou 30 92 22 58 + 30 92 22 60 ou 30 92 22 59 + 30 92 22 61	1	
Compasso médio	30 92 22 63	1	
Kit fecho 3º ponto	30 92 22 66		1

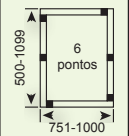
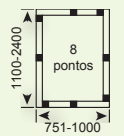
Designação	Referência		
Kit oscilo-batente	30 92 22 46 (branco) 30 92 22 47 (preto)	1	
Cremones	30 92 22 50 ou 51 ou 30 92 22 52 ou 53 ou 30 92 22 58 + 30 92 22 60 ou 30 92 22 59 + 30 92 22 61	1	
Compasso grande	30 92 22 64	1	
Kit fecho 3º ponto	30 92 22 66	1	2

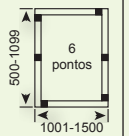
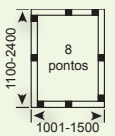
Designação	Referência		
Kit oscilo-batente	30 92 22 46 (branco) 30 92 22 47 (preto)	1	
Cremones	30 92 22 50 ou 51 ou 30 92 22 52 ou 53 ou 30 92 22 58 + 30 92 22 60 ou 30 92 22 59 + 30 92 22 61	1	
Compasso grande	30 92 22 64	1	
Compasso suplementar	30 92 22 65	1	
Kit fecho 3º ponto	30 92 22 66	1	2

Ferragens para a 2ª folha

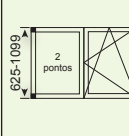
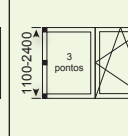
Designação	Referência		
Kit dobradiça 2ª folha	30 92 22 68 (branco) 30 92 22 69 (preto)	1	
Kit fechos para 2ª folha	30 92 22 70	1	
Conjunto ponto fecho suplementar	30 92 22 71		1

Peso máximo da folha: 120 kg (alumínio + vidro)



(confirmar com o quadro de dimensão/aplicação do mapa de montagem da ferragem O-B)

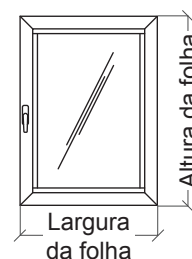
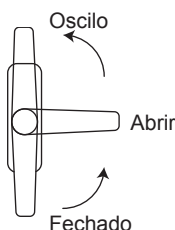

Largura mínima: 340 mm / Largura máxima: 1500 mm
 Altura mínima: 500 mm / Altura máxima: 2400 mm (vão de 1 folha)
 Altura mínima: 625 mm / Altura máxima: 2400 mm (vão de 2 folhas)



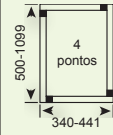

As medidas indicadas reportam-se às dimensões da folha móvel do vão

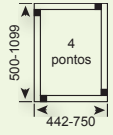
Ferragens para oscilo-batente com transmissão

Designação	Referência		
Kit oscilo-batente com transmissão	30 92 22 48 (branco) 30 92 22 49 (preto)	1	
Puxador	30 92 22 54 ou 55 ou 30 92 22 56 ou 57	1	
Compasso pequeno	30 92 22 62	1	
Kit fecho 3º ponto	30 92 22 66		1

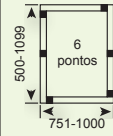
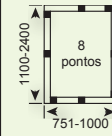
Designação	Referência		
Kit oscilo-batente com transmissão	30 92 22 48 (branco) 30 92 22 49 (preto)	1	
Puxador	30 92 22 54 ou 55 ou 30 92 22 56 ou 57	1	
Compasso médio	30 92 22 63	1	
Kit fecho 3º ponto	30 92 22 66		1

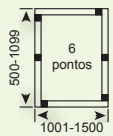
Designação	Referência		
Kit oscilo-batente	30 92 22 48 (branco) 30 92 22 49 (preto)	1	
Puxador	30 92 22 54 ou 55 ou 30 92 22 56 ou 57	1	
Compasso grande	30 92 22 64	1	
Kit fecho 3º ponto	30 92 22 66	1	2

Designação	Referência		
Kit oscilo-batente	30 92 22 48 (branco) 30 92 22 49 (preto)	1	
Puxador	30 92 22 54 ou 55 ou 30 92 22 56 ou 57	1	
Compasso grande	30 92 22 64	1	
Compasso suplementar	30 92 22 65	1	
Kit fecho 3º ponto	30 92 22 66	1	2

Ferragens para a 2ª folha

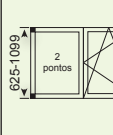
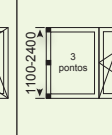
Designação	Referência		
Kit dobradiça 2ª folha	30 92 22 68 (branco) 30 92 22 69 (preto)	1	
Kit fechos para 2ª folha	30 92 22 70	1	
Conjunto ponto fecho suplementar	30 92 22 71		1

Peso máximo da folha: 120 kg (alumínio + vidro)

(confirmar com o quadro de dimensão/aplicação do mapa de montagem da ferragem O-B)

Largura mínima: 340 mm / Largura máxima: 1500 mm
 Altura mínima: 500 mm / Altura máxima: 2400 mm (vão de 1 folha)
 Altura mínima: 625 mm / Altura máxima: 2400 mm (vão de 2 folhas)

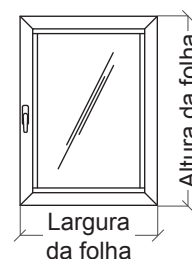
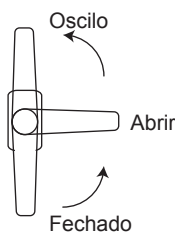

As medidas indicadas reportam-se às dimensões da folha móvel do vão