



SOCIEDADE
DE FERRAGENS, Lda.

1987 - 2007
20 anos



PME líder

catálogo
2010

apresentação

A empresa FCL - Sociedade de Ferragens, Lda, iniciou a sua actividade em 1987 e dedica-se à comercialização de ferragens e componentes para as indústrias de mobiliário, carpintaria, ferro e alumínio.

Ao longo do tempo e até encontrarmos a nossa actual missão, com representação das mais prestigiadas marcas, efectuámos um percurso do qual nos orgulhamos e que nos confere o mérito de sermos actualmente líder de mercado no distrito de Viseu.

Em 1992 foi criada a 1ª loja na rua João Mendes, com uma pequena área, que contava apenas com um funcionário, para além do fundador.

Em 1998, para dar resposta à necessidade, houve uma mudança para novas instalações, na rua Dr. César Anjo, junto à rotunda Carlos Lopes em Viseu. Contamos actualmente com 600 m2 de área coberta e 10 colaboradores efectivos, englobando uma força de vendas de 2 técnicos especializados que garantem a cobertura total em termos de distribuição, nos distritos de Viseu e Guarda.

A existência de um considerável stock e uma frota de viaturas permite-nos garantir entregas semanais em qualquer zona de influência.

Em 2009, fomos distinguidos pelo IAPMEI com o estatuto PME Líder pela qualidade da performance e perfil de risco, no âmbito do programa FINCRESCER.

O sucesso da nossa empresa, é fruto do trabalho de uma equipa de profissionais constituída pelos nossos colaboradores directos e restantes parceiros de negócio nos quais temos a honra de incluir os nossos Clientes, Fornecedores e Amigos.

Servir sempre melhor é o nosso principal objectivo.



1987 - 2007
20 anos



Dobradiça lisa 2" em chapa 1,4 mm

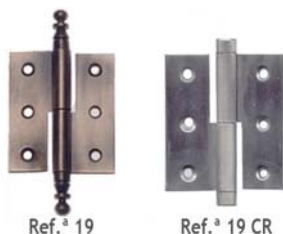

Acabamento	F.Amarelo	F. Preto carrapeta plástica	F.ox. Franc. F.ox. Preto F.Lacado	Ferro Niq. Mate	F.Niquelado F.Latonado	Ferro Ox. Esp.	Aço Inox Escovado
		400	400	150	150	150	150
Acabamento	Latão Lacado fiel latão	Latão Polido fiel latão	Latão Polido fiel ferro	Latão ox.fr./ox.pr. fiel latão	Latão ox.fr./ox.pr. fiel ferro	Latão Niquelado fiel latão	Latão Niq. Escov. fiel latão
	150	150	150	150	150	150	150

Dobradiça inquinada 2" em chapa 1,4 mm



Acabamento	F.Amarelo	F. Preto carrapeta plástica	F.ox. Franc. F.ox. Preto F.Lacado	Ferro Niq. Mate	F.Niquelado F.Latonado	Ferro Ox. Esp.	Aço Inox Escovado
		350	350	120	120	120	120
Acabamento	Latão Lacado fiel latão	Latão Polido fiel latão	Latão Polido fiel ferro	Latão ox.fr./ox.pr. fiel latão	Latão ox.fr./ox.pr. fiel ferro	Latão Niquelado fiel latão	Latão Niq. Escov. fiel latão
	120	120	120	120	120	120	120

Dobradiça mista 2" em chapa 1,4 mm

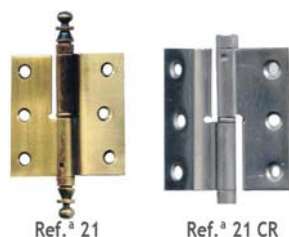

Acabamento	F.Amarelo	F. Preto carrapeta plástica	F.ox. Franc. F.ox. Preto F.Lacado	Ferro Niq. Mate	F.Niquelado F.Latonado	Ferro Ox. Esp.	Aço Inox Escovado
		250	250	100	100	100	100
Acabamento	Latão Lacado fiel latão	Latão Polido fiel latão	Latão Polido fiel ferro	Latão ox.fr./ox.pr. fiel latão	Latão ox.fr./ox.pr. fiel ferro	Latão Niquelado fiel latão	Latão Niq. Escov. fiel latão
	100	100	100	100	100	100	100

Dobradiça rabo ao centro 2" em chapa 1,4 mm

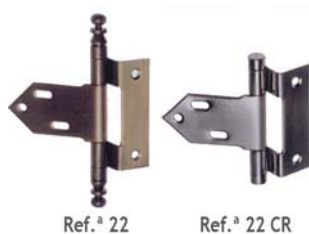

Acabamento	F.Amarelo	F. Preto carrapeta plástica	F.ox. Franc. F.ox. Preto F.Lacado	Ferro Niq. Mate	F.Niquelado F.Latonado	Ferro Ox. Esp.	Aço Inox Escovado
		200	200	60	60	60	60
Acabamento	Latão Lacado fiel latão	Latão Polido fiel latão	Latão Polido fiel ferro	Latão ox.fr./ox.pr. fiel latão	Latão ox.fr./ox.pr. fiel ferro	Latão Niquelado fiel latão	Latão Niq. Escov. fiel latão
	60	60	60	60	60	60	60

Dobradiça rabo ao lado 2" em chapa 1,4 mm

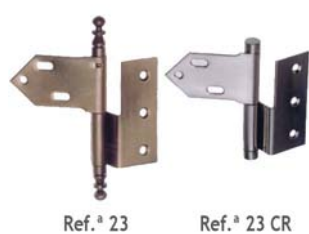

Acabamento	F.Amarelo	F. Preto carrapeta plástica	F.ox. Franc. F.ox. Preto F.Lacado	Ferro Niq. Mate	F.Niquelado F.Latonado	Ferro Ox. Esp.	Aço Inox Escovado
		200	200	60	60	60	60
Acabamento	Latão Lacado fiel latão	Latão Polido fiel latão	Latão Polido fiel ferro	Latão ox.fr./ox.pr. fiel latão	Latão ox.fr./ox.pr. fiel ferro	Latão Niquelado fiel latão	Latão Niq. Escov. fiel latão
	60	60	60	60	60	60	60

Dobradiça inquinada 2 1/2 em chapa 1,2 mm

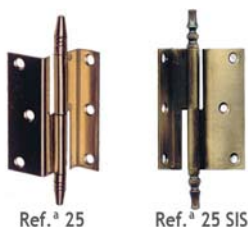

Acabamento	F.Amarelo	Ferro Lacado	F.ox. Franc. F.ox. Preto F.Lacado	Ferro Niq. Mate	F.Niquelado F.Latonado	Ferro Ox. Esp.	Aço Inox Escovado
		300	120	120	120	120	120
Acabamento	Latão Lacado fiel latão	Latão Polido fiel latão	Latão Polido fiel ferro	Latão ox.fr./ox.pr. fiel latão	Latão ox.fr./ox.pr. fiel ferro	Latão Niquelado fiel latão	Latão Niq. Escov. fiel latão
	120	120	120	120	120	120	120

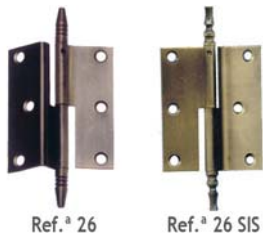
Dobradiça mista 2 1/2 em chapa 1,2 mm

Ref.ª 26

Ref.ª 26 SIS

Acabamento	F.Amarelo	Ferro Lacado	F.ox. Franc.	Ferro Niq. Mate	F.Niquelado	Ferro Ox. Esp.	Aço Inox Escovado
	F.Preto		F.ox. Preto		F.Latonado		
	250	100	100	100	100	100	100
Acabamento	Latão Lacado fiel latão	Latão Polido fiel latão	Latão Polido fiel ferro	Latão ox.fr./ox.pr. fiel latão	Latão ox.fr./ox.pr. fiel ferro	Latão Niquelado fiel latão	Latão Niq. Escov. fiel latão
	100	100	100	100	100	100	100

Dobradiça inquinada 2 1/2 em chapa 1,4 mm

Ref.ª 27

Ref.ª 27 SIS

Acabamento	F.Amarelo	Ferro Lacado	F.ox. Franc.	Ferro Niq. Mate	F.Niquelado	Ferro Ox. Esp.	
	F.Preto		F.ox. Preto		F.Latonado		
	300	50	50	50	50	50	
Acabamento	Latão Lacado fiel latão	Latão Polido fiel latão	Latão Polido fiel ferro	Latão ox.fr./ox.pr. fiel latão	Latão ox.fr./ox.pr. fiel ferro	Latão Niquelado fiel latão	Latão Niq. Escov. fiel latão
	50	50	50	50	50	50	50

Dobradiça mista 2 1/2 em chapa 1,4 mm

Ref.ª 28

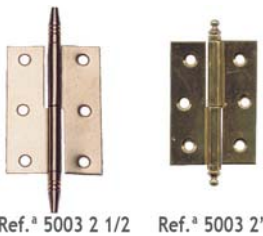

Ref.ª 28 SIS

Acabamento	F.Amarelo	Ferro Lacado	F.ox. Franc.	Ferro Niq. Mate	F.Niquelado	Ferro Ox. Esp.	
	F.Preto		F.ox. Preto		F.Latonado		
	250	100	100	100	100	100	
Acabamento	Latão Lacado fiel latão	Latão Polido fiel latão	Latão Polido fiel ferro	Latão ox.fr./ox.pr. fiel latão	Latão ox.fr./ox.pr. fiel ferro	Latão Niquelado fiel latão	Latão Niq. Escov. fiel latão
	100	100	100	100	100	100	100

Dobradiça lisa 2" e 2 1/2 em chapa 1,2 mm

Ref.ª 5003 2 1/2

Ref.ª 5003 2"

2"	F.Amarelo	F.ox. Franc.	Ferro Niq. Mate	F.Niquelado	Ferro Ox. Esp.	Latão Polido fiel ferro	Latão ox.fr./ox.pr. fiel ferro
	F.Preto	F.ox. Preto		F.Latonado			
	250	100	100	100	100	100	100
2 1/2"	F.Amarelo	F.ox. Franc.	Ferro Niq. Mate	F.Niquelado	Ferro Ox. Esp.	Latão Polido fiel ferro	Latão ox.fr./ox.pr. fiel ferro
Acabamento	F.Preto	F.ox. Preto		F.Latonado			
	400	150	150	150	150	150	150

Dobradiça lisa 2 1/2 em chapa 1,2 mm



Ref.ª 5002

Acabamento	F.Amarelo	Ferro Lacado	F.ox. Franc.	Ferro Niq. Mate	F.Niquelado	Ferro Ox. Esp.	
	F.Preto		F.ox. Preto		F.Latonado		
	400	150	150	150	150	150	
Acabamento	Latão Lacado fiel latão	Latão Polido fiel latão	Latão Polido fiel ferro	Latão ox.fr./ox.pr. fiel latão	Latão ox.fr./ox.pr. fiel ferro	Latão Niquelado fiel latão	Latão Niq. Escov. fiel latão
	150	150	150	150	150	150	150

Dobradiça lisa 2" e 2 1/2 em chapa 1,2 mm

Ref.ª 5001 2 1/2

Ref.ª 5001 2"

2"	F.Amarelo	F.ox. Franc.	Ferro Niq. Mate	F.Niquelado	Ferro Ox. Esp.	Latão Polido fiel ferro	Latão ox.fr./ox.pr. fiel ferro
	F.Preto	F.ox. Preto		F.Latonado			
	500	100	100	100	100	100	100
2 1/2"	F.Amarelo	F.ox. Franc.	Ferro Niq. Mate	F.Niquelado	Ferro Ox. Esp.	Latão Polido fiel ferro	Latão ox.fr./ox.pr. fiel ferro
Acabamento	F.Preto	F.ox. Preto		F.Latonado			
	500	100	100	100	100	100	100

Dobradiça lisa 2" e 2 1/2 em chapa 1 e 1,2 mm



Ref.ª 5001 C/B 2 1/2 Ref.ª 5001 C/B 2"

2" Acabamento	F.Amarelo	F.ox. Franc.	Ferro Niq. Mate	F.Niquelado	Ferro Ox. Esp.	Latão Polido fiel ferro	Latão ox.fr./ox.pr. fiel ferro
	F.Preto	F.ox. Preto		F.Latonado			
	500	100	100	100	100	100	100
2 1/2 Acabamento	F.Amarelo	F.ox. Franc.	Ferro Niq. Mate	F.Niquelado	Ferro Ox. Esp.	Latão Polido fiel ferro	Latão ox.fr./ox.pr. fiel ferro
	F.Preto	F.ox. Preto		F.Latonado			
	500	100	100	100	100	100	100

Dobradiça de 1 aba 2" em chapa 1,2 mm

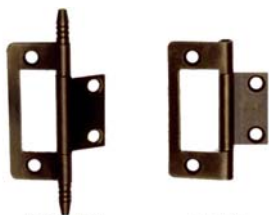

Ref.ª 31-CP Ref.ª 31

31 Acabamento	F.Amarelo	F.ox. Franc.	Ferro Niq. Mate	F.Niquelado	Ferro Ox. Esp.	Latão Polido fiel ferro	Latão ox.fr./ox.pr. fiel ferro
	F.Preto	F.ox. Preto		F.Latonado			
	500	100	100	100	500	100	100
31-CP Acabamento	F.Amarelo	F.ox. Franc.	Ferro Niq. Mate	F.Niquelado	Ferro Ox. Esp.	Latão Polido fiel ferro	Latão ox.fr./ox.pr. fiel ferro
	F.Preto	F.ox. Preto		F.Latonado			
	500	100	100	100	500	100	100

Dobradiça 816 / 817 e 818



Ref.ª 816 Ref.ª 817 Ref.ª 818

Refª	Medida mm	Ferro Amar.	Ferro Zinc.	Ferro ox.fr.	Latão Pol.	Latão ox.fr.	
816	1"	✗	✗				50
816	1 1/4"	✗	✗				50
816	1 1/2"	✗	✗				50
816	1 3/4"	✗	✗				50
816	2"	✗	✗				50
817	1 1/4"	✗		✗			50
818	1 1/4"				✗	✗	50

Dobradiças invisíveis



Ref.ª 51-A Ref.ª 51-C Ref.ª 51-D
Ref.ª 511 Ref.ª 511-PL

Refª	Medida mm	Latão/f.Zin.	Ferro Amar.	Plást./f.Am	
51-A	66	✗			100
51-C	60		✗		200
51-D	54		✗		200
511	∅ 12	✗			48
511	∅ 14	✗			24
511	∅ 16	✗			24
511-PL	∅ 14			✗	1000

Dobradiça tubo ∅ 14 e varão mm ∅ 12 mm em latão ox. fr.

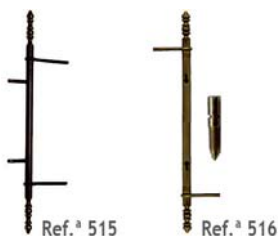

Ref.ª 515 Ref.ª 516

Refª	150	200	250	300	350	400	450	500	550
515									
516									
Refª	600	650	700	750	800	850	900	950	1000
515									
516									
Refª	1050	1100	1150	1200	1250	1300	1350	1400	1500
515									
516									

Dobradiça 2" e 2 1/2 em chapa 1,4 e 1,6 mm





Ref.ª 20FB Ref.ª 2000 Ref.ª 30-G Ref.ª D414



Refª	Z.ox. Franc.	F.ox. Franc.	
	Z.ox. Preto	F.ox. Preto	
20FB		✗	300
2000		✗	100
30-G		✗	300
D414	✗		100

Dobradiça p/ portas de vidro e giros



78-B Acabamento	Niquel Mate		50
62-B Acabamento	Niquel Mate		50



Medida mm		F. Amarelo	Medida mm		F. Amarelo
50	2 Maços		70	2 Maços	
60	2 Maços		80	2 Maços	

Fixador p/ perna de mesa e trinco de mesa

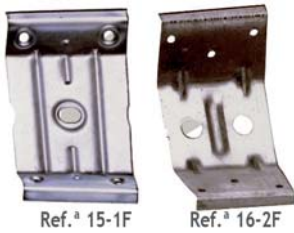

Refª	Ferro Amarelo	Ferro Zincado	
15-1F	X	X	100
16-2F	X	X	100



Ferro Amarelo	
	60

Dobradiça de segurança 5"





Refª	Latão Ox. Franc.	Aço Inox Escovado	
160	X		10
155		X	10

Refª	F.ox. Franc. F.ox. Preto	Ferro Latonado	Ferro Niq. Mate	
150	X	X	X	10
150 R		X	X	10

Dobradiça danco em ferro niquelado





Refª	Descrição	
611	Dobradiça Articulada	50
660 P	Dobr. Recta copo 26 mm	500
660 M	Dobr. C/8 copo 26 mm	500
660 C	Dobr. C/17 copo 26 mm	500

Refª	Descrição	
780 P	Dobr. Recta copo 35 mm	300
780 M	Dobr. C/8 copo 35 mm	300
780 C	Dobr. C/17 copo 35 mm	300

Dobradiça danco em ferro niquelado





Refª	Descrição	
615 P	Dobr. Recta copo 35 mm	500
500 P	Dobr. Clic recta copo 35 mm	250
500 M	Dobr. Clic C/8 copo 35 mm	250
500 C	Dobr. Clic C/17 copo 35 mm	250

Refª	Descrição	
850 P	Dobr. Recta copo 35 mm	300
850 M	Dobr. C/8 copo 35 mm	300
850 C	Dobr. C/17 copo 35 mm	300

Dobradiça em ferro niquelado



Refª	Descrição	
B300P	Dobr. Recta copo 26 mm	250
B300M	Dobr. C/8 copo 26 mm	250
B300C	Dobr. C/17 copo 26 mm	250
03AP	Dobr. Recta copo 35 mm	250

Refª	Descrição	
03BM	Dobr. C/8 copo 35 mm	250
03CC	Dobr. C/17 copo 35 mm	250
04BP	Dobr. Recta copo 35 mm	250
04BM	Dobr. C/8 copo 35 mm	250

Chassos e tranqueiros de cama

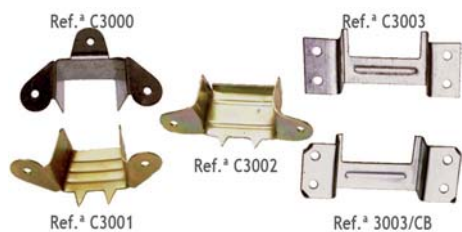

Refª	Ferro Zincado	Ferro Amarelo	
C3000	X	X	500
C3001	X	X	500
C3002	X	X	500

Refª	Ferro Zincado	Ferro Amarelo	
C3003	X	X	500
3003/CB	X	X	500

Engates de cama

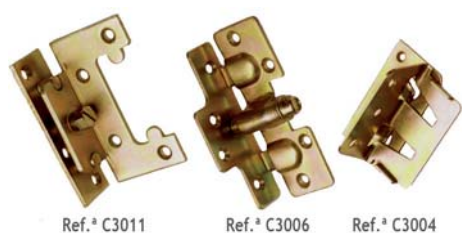

Refª	Ferro Amarelo	
C3004	X	100
C3006	X	100
C3011	X	100

Parafusos Dª Mª c/ cabeça de latão e armar em ferro



Refª	Medida mm	Ferro Pol.	Ferro Amar.	
107	60	X	X	120
107	80	X	X	120
107	100	X	X	120
107	120	X	X	120

Refª	Medida mm	Ferro Pol.	Ferro Amar.	
107	140	X	X	120
12	100		X	50
12	120		X	50
12	140		X	50

Engates de cama



Refª	Ferro Zincado	Ferro Amarelo	
C895	X		50
C896	X		1000
C3005		X	48

Fechos magnéticos



Refª	Força Kg	Branco	Castanho	
400	4	X	X	100
401	6	X	X	100
402	6	X	X	100
403	6	X	X	100

Refª	Força Kg	Branco	Castanho	
590	7	X	X	100
598	7	X	X	100
609G	12	X	X	100

Fechos magnéticos



Refª	Força Kg	Castanho	
463	7	X	100
463	4	X	100

Refª	Força Kg	Castanho	
464	2	X	100
894		X	12

Fechos de roletos em nylon



Refª	Ferro Amarelo	Ferro Ox. Franc.	Nylon Castanho Branco	
404			X	500
429/RN	X			100
430	X	X		100

Fechaduras p/ móveis e chave em zamak



Refª	Medida mm	Niquelado	Latonado	Oxidado	
F22	15	X	X	X	20
F22	20	X	X	X	20
F22	25	X	X	X	20
F22	30	X	X	X	20
F22	35	X	X	X	12

Refª	Medida mm	Niquelado	Latonado	Oxidado	
F22	40	X	X	X	12
F22	50	X	X	X	12
029	15	X			12
F223	15	X		X	12
Ch22		X	X	X	50

NOTA: A fechadura 223 é fornecida c/ 2 varetas de metro

Fechaduras p/ móveis / chave e espelhos de latão



Refª	Medida mm	F. Amarelo	F.c/testa L.	
30	15	X		60
30	20	X		60
910	20	X		60
910	25	X		60
840	20 a 30		X	60
405		X		60

	Latão Pol.	Latão ox.Fr.L.	Niq. Mate	
893	X	X	X	60
896	X	X	X	50
895	X	X	X	50

Fechos tic tac e hi-fi



Refª	Preto	Castanho	Branco	
F607		X	X	100
F608	X			100
F609	X			100
F612		X		100
		Amarelo	Zincado	
F610		X	X	100

Fechaduras p/ móveis c/ canhão



Refª	Medida mm	Amarela	Niquelada	
X-853	19 x 22		X	12
918	19 x 22	X		12
224	17 x 20		X	10
929			X	10
L203	19 x 22		X	12

Fechos de esferas de latão e ferro zincado

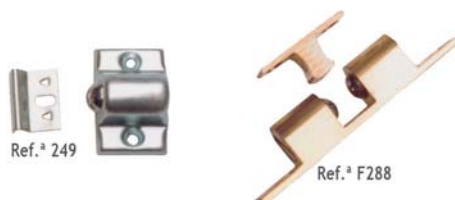

Refª	Medida em mm	Latão Niq. Mate	Latão Polido	Ferro Zincado	
249				X	100
F288	43	X	X		50
F288	50	X	X		50
F288	60	X	X		50
F288	70	X	X		50

Batentes e Tapa parafusos autocolantes de plástico

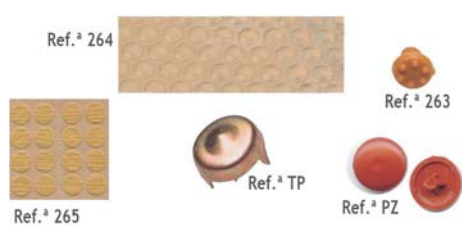

Refª	Cores Disponíveis	
263	Branco / Transparente Castanho	1000
264	Transparente	5000
265	Branco / Preto / Pinho / Mogno Carvalho / Faia / Cinza / Creme	1000

Refª	Cores Disponíveis	
TP	Zinco Amarelo	1000
PZ	Branco / Preto / Pinho mel Mogno / Creme	2000

Suportes de prateleira e vidro



Refª	Medida do eixo \varnothing mm	Cores Disponíveis	
200	1,5	Castanho / Branco	1000
201	5	Castanho / Pinho mel Branco	1000
202	5	Castanho / Pinho mel Branco / Transparente	1000
203	5	Latão Polido	500
204	5	Transparente	500
205	5	Transparente	1000
212	5	Zincado / Amarelo	500

Refª	Medida do eixo \varnothing mm	Cores Disponíveis	
213	7	Amarelo	500
213	7	Niquelado	500
217	8	Latonado / Niquelado	1000
218	8	Castanho / Pinho mel Branco	1000
225	5	Niquelado	1000
226	5	Branco / Castanho Pinho mel / Transparente	500

Esquadros p/ móveis em plástico e ferro zincado



Refª	Medida mm	Cores Disponíveis	
207	24	Castanho / Branco Pinho mel	200
208	42	Castanho / Pinho mel Branco	200
209	22	Zincado	200
210	43	Zincado	200

Refª	Medida mm	Cores Disponíveis	
219	19	Castanho / Branco Pinho mel	200
MR	93	Zincado	500
18-C	64	Zincado / Amarelo	100

Ligadores de móvel



Refª	Medida mm	Cores Disponíveis	
06	M6	Niquelado/Latonado/Oxidado	200
07	M6	Castanho/Pinho mel/Branco	200
09	M6 x 26	Zincado Amarelo	100
09	M6 x 30	Zincado Amarelo	100
09	M6 x 33	Zincado Amarelo	100
09	M6 x 35	Zincado Amarelo	100

Refª	Medida mm	Cores Disponíveis	
09	M6 x 40	Zincado Amarelo	100
09	M6 x 45	Zincado Amarelo	100
09	M6 x 50	Zincado Amarelo	100
L223		Castanho / Branco	100
426	M5 x 55	Amarelo	1000
316	M5 x 14	Branco/Castanho/Pinho mel	1000

Deslizadores de móvel



Refª	Diâmetro em mm	Cores Disponíveis	
D206	15	Branco / Castanho	1000
220	15	Branco / Castanho	1000
221	15	Branco / Castanho	1000
222/15	15	Niquelado	500

Refª	Diâmetro em mm	Cores Disponíveis	
222/20	20	Niquelado	500
D227	18	Branco / Castanho	500
D227	25	Branco / Castanho	500

Suportes e cantos de espelho



Refª	Amarelo	Niquelado	Transparente	
211			X	1000
214			X	1000
215	X	X		500
216	X	X		500
TR 0	X			1000

Refª	Amarelo	Niquelado	Transparente	
TR 1	X			1000
TR 2	X			1000
TR 3	X			1000
TR 4	X			1000
S-AR	Zincado		X	200

Suportes pelicano



Ref.ª 15

Ref.ª 14P

Ref.ª 14G

Refª	Medidas mm		Acabamento	Preço unidade	
	Min.	Max.			
14P	4	24	Niq. Mate	X	50
14G	4	40	Niq. Mate	X	25
15	5	8	Cromado	X	100

Calhas plásticas p/ vidro e portas de correr



Refª	Medida em mm	Cores Disponíveis	
11		Castanho / Branco	50
13	5	Dourado / Mate Castanho / Branco	125
H16	8/12/16	Castanho / Branco Pinho mel	125
05	5	Castanho / Branco	125

Refª	Medida em mm	Cores Disponíveis	
C-81		Castanho / Branco	125
C-192		Castanho / Branco	125
R-81		Zincado	100
F-192		Amarelo	100

Perfil de vedação p/ portas e vidros



Refª	Cores Disponíveis	
003	Branco/Carvalho Mogno	100
08	Branco/Creme/Mogno Pinho mel/Castanho esc.	350
V016	Branco/Mogno/Carvalho Castanho escuro	100
V116	Branco/Mogno/Carvalho Castanho escuro	100
V117	Branco/Mogno/Carvalho Castanho escuro	100

Refª	Cores Disponíveis	
V615	Branco/Mogno Carvalho	200
2073	Zincado	1
2083	Zincado	1
2093	Zincado	1
2103	Zincado	1

Batentes p/ portas e cruzetas p/ azulejo



Refª	
CRZ	200

Refª	Cores Disponíveis	
711	Branco / Castanho	100
712	Branco / Castanho / Pinho mel	100

Refª	Cores Disponíveis	
713	INOX	50
714	Branco / Castanho	100

Puxadores p/ móveis

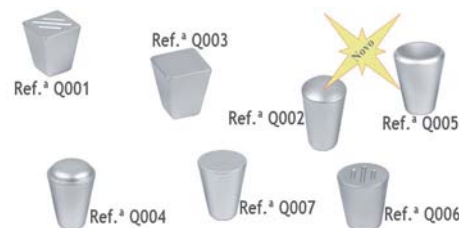

Refª	Diâmetro \varnothing em mm			
	18	22	26	
Q001	X	X	X	50
Q002	X	X	X	50
Q003	X	X	X	50
Q004	X	X	X	50

Refª	Diâmetro \varnothing em mm			
	18	22	26	
Q005	X	X	X	50
Q006	X	X	X	50
Q007	X	X	X	50
Acabamento	ANOX 20 ANOS GARANTIA			

Puxadores p/ móveis



Refª	Diâmetro \varnothing em mm					
	15	20	25	30	35	
Q008	X	X	X	X	X	50
Q009			X	X	X	50
Q010				X	X	50
Q011			X	X	X	50

Refª	Diâmetro \varnothing em mm					
	15	20	25	30	35	
Q012				X	X	50
Q013			X	X	X	50
Q014			X	X	X	50
Acabamento	ANOX 20 ANOS GARANTIA					

Cabides e suporte de corrimão

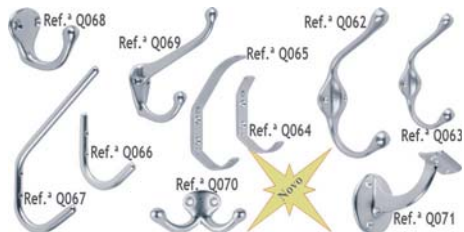

Ref ^º	Altura total em mm	
Q062	94	50
Q063	117	50
Q064	70	50
Q065	104	50

Ref ^º	Altura total em mm	
Q066	69	50
Q067	150	50
Q068	43	50

Ref ^º	Altura total em mm	
Q069	87	50
Q070	39	50
Q071	68	50

Acabamento **ANOX 20 ANOS GARANTIA**

Asas p/ móveis



Ref ^º	Medida entre furos em mm				
	76	89	96	128	
Q016	X	X			50
Q017			X	X	50
Q018			X	X	50

Ref ^º	Medida entre furos em mm				
	76	89	96	128	
Q019			X	X	50
Q020			X	X	50

Acabamento **ANOX 20 ANOS GARANTIA**

Asas p/ móveis



Ref ^º	Medida entre furos em mm				
	94	96	120	128	
Q021	X				50
Q022			X		50
Q023		X		X	50
Q024		X		X	50

Ref ^º	Medida entre furos em mm				
	94	96	120	128	
Q025		X		X	50
Q026		X		X	50

Acabamento **ANOX 20 ANOS GARANTIA**

Asas p/ móveis



Ref ^º	Medida entre furos em mm					
	73	88	96	110	128	
Q027	X	X		X		50
Q028			X		X	50

Ref ^º	Medida entre furos em mm					
	73	88	96	110	128	
Q029			X		X	50
Q030			X		X	50

Acabamento **ANOX 20 ANOS GARANTIA**

Asas em zamak p/ móveis



Ref ^º	Medida entre furos em mm			Acabamento	
	64	96	128		
481	X			Niquel Escov.	50
481	X			Ox. Francês	50
0634		X	X	Niquel Mate	50

Ref ^º	Medida entre furos em mm			Acabamento	
	64	96	128		
0634				Niquel Escov.	50
175	X	X		Niquel Mate	50
175		X		Ox. Francês	50

Ref ^º	Medida entre furos em mm			Acabamento	
	32	96	128		
0732	X	X		Niquel Mate	50

Asas em zamak p/ móveis

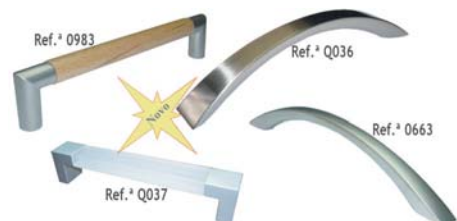

Ref ^º	Med.entre fur.em mm		Acabamento	
	128	160		
Q036	X		Niquel Escov.	50
Q037	X	X	Alum./Acril.	50
0663	X		Niquel Mate	50

Ref ^º	Med.entre fur.em mm		Acabamento	
	128	160		
0663	X		Niquel Escov.	50
0663	X		Ox. Francês	50
0983		X	Mate / Faia	50

Asas em alumínio p/ móveis

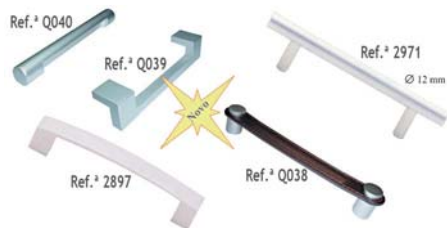

Refª	Medida entre furos em mm				
	64	96	128	160	
Q038			X	X	50
Q039			X		50
Q040	X	X	X	X	50
2897			X		50
2971		X	X	X	50

Refª	Medida entre furos em mm				
	192	224	320	480	
Q039	X	X			50
Q040	X				50
2971	X	X	X	X	50

Asas em zamak p/ móveis



Refª	Medida entre furos em mm					Acabamento	
	96	128	160	192	224		
A203	X	X				Niquel Mate	50
A203	X	X				Ox. Françaes	50
172			X	X		Lac. Mate	50
172			X	X	X	Niq. Escov.	50
791	X	X	X	X	X	Niquel Mate	50
791	X	X	X	X		Ox. Françaes	50

Refª	Medida entre furos em mm					Acabamento	
	96	128	160	192	224		
991	X	X	X	X		Niquel Mate	50
991		X	X			Ox. Françaes	50
991		X	X			Cromado	50
991		X	X			Pintado	50
690	X	X				Niquel Mate	50

Asas em zamak p/ móveis



Refª	Medida entre furos em mm				Acabamento	
	32	64	96	128		
312	X				Cromado	50
312	X				Ox. Preto	50
348			X		Niquel Mate	50
348			X		Ox. Françaes	50
394	X	X	X		Niquel Mate	50
394	X	X	X		Ox. Françaes	50

Refª	Medida entre furos em mm				Acabamento	
	32	64	96	128		
398			X	X	Niquel Mate	50
398			X	X	Ox. Françaes	50
990	X	X	X	X	Niquel Mate	50
990	X	X	X	X	Ox. Françaes	50
990	X	X	X	X	Cromado	50

Asas em zamak p/ móveis

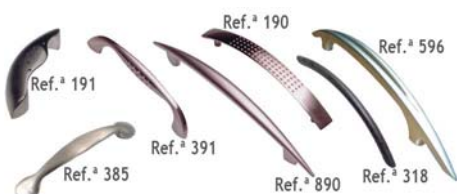

Refª	Medida entre furos em mm			Acabamento	
	64	96	128		
190		X	X	Niq. Escov.	50
190		X	X	Ox. Françaes	50
190		X	X	Niquel Mate	50
191	X			Niq. Escov.	50
318		X	X	Ox. Françaes	50
318		X	X	Cromado	50

Refª	Medida entre furos em mm			Acabamento	
	64	96	128		
318		X	X	Niquel Mate	50
385		X	X	Niq. Escov.	50
391			X	Niq. Escov.	50
596			X	Niquel Mate	50
890			X	Niquel Mate	50

Asas em zamak p/ móveis



Refª	Medida entre furos em mm			Acabamento	
	96	128	256		
70J	X			Niquel Mate	50
75J	X	X	X	Niquel Mate	50
80J	X			Niquel Mate	50
Q042		X		Niquel Escov.	50
Q042		X		Ox. Françaes	50

Refª	Medida entre furos em mm			Acabamento	
	96	128	256		
176	X			Niquel Mate	50
362	X			Ox. Françaes	50
362	X			Niquel Mate	50
	160	192	256		
75J	X	X	X	Niquel Escov.	50

Asas em zamak p/ móveis



Refª	Medida entre furos em mm				Acabamento	
	64	96	128	160		
280	X	X	X		Niq.Mate/Faixa	50
309	X	X	X		Ox. Françaes	50
309	X	X	X		Niquel Mate	50
309	X	X	X		Cromado	50
309	X	X	X		Pintado	50

Refª	Medida entre furos em mm				Acabamento	
	64	96	128	160		
838	X	X			Ox. Françaes	50
Q041				X	Cr. Mate	50
442	X	X	X	X	Niquel Mate	50
442	X	X	X	X	Ox. Françaes	50
790			X		Niquel Mate	50

Asas em zamak p/ móveis



Refª	Medida entre furos em mm				Acabamento	50
	64	96	128	160		
MM 200		X	X	X	Niquel Mate	50
091	X	X	X	X	Niquel Mate	50
091	X	X	X	X	Ox. Françês	50
330		X	X	X	Niquel Mate	50
330		X	X	X	Ox. Françês	50
330		X	X	X	Latonado	50

Refª	Medida entre furos em mm				Acabamento	50
	64	96	128	160		
330		X	X	X	Pintado	50
335			X		Ox. Françês	50
335			X		Niquel Mate	50
491			X		Niq. Escov.	50
691			X		Niq. Escov.	50

Pingentes em zamak p/ móveis



Refª	Acabamento Ox. Françês	50
1000	X	50
1000A	X	50
1000M	X	50
1000P	X	50

Refª	Acabamento Ox. Françês	50
1000R	X	50
1000S	X	50
2000	X	50

Refª	Acabamento Ox. Françês	50
2000B	X	50
2000BR	X	50
2000R	X	50

Pingentes em zamak p/ móveis



Refª	Acabamento Ox. Françês	50
115	X	50
131	X	50
132	X	50
135	X	50

Refª	Acabamento Ox. Françês	50
136	X	50
137	X	50
152	X	50

Refª	Acabamento Ox. Françês	50
155	X	50
415	X	50
685	X	50

Pingentes em zamak p/ móveis



Refª	Acabamento Ox. Françês	50
413	X	50
414	X	50
420	X	50
421	X	50

Refª	Acabamento Ox. Françês	50
422	X	50
416/423	X	50
420/423	X	50

Refª	Acabamento Ox. Françês	50
Q043	X	50
Q044	X	50
Q045	X	50

Asas em aço inox Ø 12 mm p/ móveis



Asas Nacionais

Refª	Comprimento total em mm						50
	160	192	224	256	288	306	
550	Medida entre furos em mm						50
	X	X	X	X	X	X	
550	Comprimento total em mm						25
	Medida entre furos em mm						
550	X	X	X	X	X	X	

Asas em aço inox Ø 10 mm p/ móveis



Asas Nacionais

Refª	Comprimento total em mm						50
	160	192	224	256	288	306	
1200	Medida entre furos em mm						50
	X	X	X	X	X	X	
1200	Comprimento total em mm						25
	Medida entre furos em mm						
1200	X	X	X	X	X	X	

Asas em aço inox Ø 10 e 12 mm p/ móveis

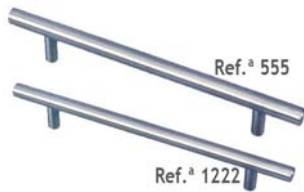

Asas Importadas

Refª	Comprimento total em mm							
	150	200	230	250	300	350	400	
	Medida entre furos em mm							
	96	128	160	192	224	288	320	
1222	X	X	X	X	X	X	X	50
555	X	X	X	X	X			50

Puxadores e asas em aço inox p/ móveis



Refª	Diametro Ø em mm						
	12	15	18	20			
105	X	X	X	X			50
Refª	Medida entre furos em mm						
	96	128	160	192	224	320	
A201	X	X	X	X	X	X	50
173	X	X	X	X	X	X	50
Q046	X	X	X	X	X		50

Asas em zamak p/ móveis

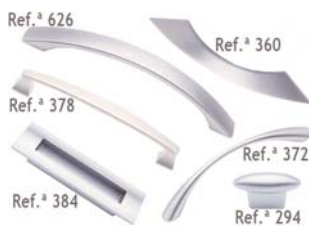

Refª	Medida entre furos em mm			Acabamento	
	96	128	160		
360	X			Niquel Escov.	50
360	X			Ox. Francês	50
372	X	X		Niquel Mate	50
372	X	X		Ox. Francês	50
378		X		Niquel Mate	50
378		X		Ox. Francês	50

Refª	Medida entre furos em mm			Acabamento	
	96	128	160		
626			X	Niquel Mate	50
626			X	Ox. Francês	50
384		X		Niquel Mate	50
294		X		Niquel Mate	50
294		X		Ox. Francês	50

Asas em zamak p/ móveis

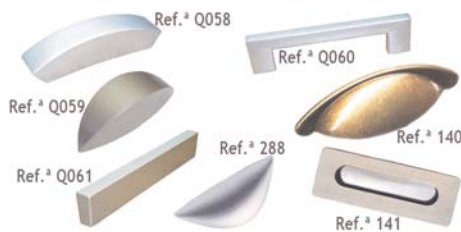

Refª	Med.entre fur.em mm		Acabamento	
	32	64		
Q058	X	X	CR. Mate	50
Q059	X		Niquel Mate	50
288	X		Niquel Mate	50
288	X		Ox. Francês	50

Refª	Med.entre fur.em mm		Acabamento	
	64	96		
Q060	X	X	CR. Mate	50
Q061	X	X	Niquel Mate	50
Q061	X	X	Cromado	50
140	X		Br. Velho	50
141		X	Niquel Escov.	50

Asas em alumínio p/ móveis





Refª	Medida entre furos em mm				
	128	160	192	224	
32G	X	X	X	X	50
719	X	X	X		50
2879	X	X	X		50
2880	X	X	X		50

Refª	32	64	96	128	
	14F	X	X	X	
60J		X	X		50
58J	X	X	X	X	50
Refª	96	128	160	192	
	127	X	X	X	
58J			X	X	50

Asas e puxadores em zamak p/ móveis



Refª	Medida entre furos em mm			Acabamento	
	96	128	160		
Q047			X	Niquel Mate	50
Q047			X	Ox. Francês	50
Q048			X	Niquel Mate	50
Q048			X	Ox. Francês	50
144	X	X		Niquel Mate	50
145	X	X		Niquel Mate	50

Refª	Medida entre furos em mm			Acabamento		
	96	128	160			
386	X	X	X	Niquel Mate	50	
386	X	X	X	Ox. Francês	50	
Refª	64	96				
	146	X	X			Ox. Francês
146	X	X			Niquel Mate	50

Asas e puxadores em zamak p/ móveis



Refª	Med.entre fur.em mm		Acabamento	Imagem
	64	78		
138	X	X	Br. Velho	50
	Diâmetro em mm			
149	40	X	Niq. Escov.	50
281	25	X	Ox. Francês	50
281	25	X	Niquel Mate	50

Refª	Med.entre fur.em mm		Acabamento	Imagem
	64	78		
Q049	Diâmetro em mm	X	Ox. Francês	50
Q050		X	Aluminio	50
Q051		X	Aluminio	50
Q052	28	X	Niquel Mate	50
Q053	26	X	Niquel Mate	50

Cabides em zamak / latão e inox



Refª	Medidas em mm	Acabamento	Imagem
C50J	50 x 75	Niquel Mate	50
C51J	120 x 75	Niquel Mate	50
C60J	60 x 78	Niquel Mate	50

Refª	Medidas em mm	Acabamento	Imagem
C61J	150 x 80	Niquel Mate	50
C170	78 x 74	Ox. Francês	50
C171	50 x 65	Inox Escov.	50

Puxadores em zamak p/ móveis



Refª	Medidas em mm	Acabamento	Imagem
20J	30 x 30	CR. Mate	50
20J	40 x 40	CR. Mate	50
57G		Niquel Mate	50
59H		Niquel Mate	50

Refª	Medidas em mm	Acabamento	Imagem
59H		Ox. Francês	50
67G		Niquel Mate	50
90J		Niquel Mate	50
104G		Niquel Mate	50

Refª	Medidas em mm	Acabamento	Imagem
509G	25 x 25	CR. Mate	50
760		Niquel Mate	50
297-A	Ø 22	Niquel Mate	50

Puxadores em zamak p/ móveis

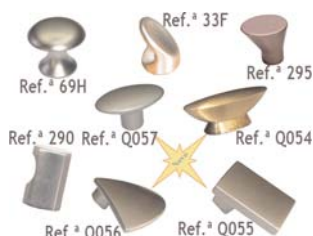

Refª	Diâmetro em mm					Acabamento	Imagem
	12	15	18	20	24		
33F					X	Niquel Mate	50
295				X		Niquel Mate	50
295				X		Cromado	50
69H					X	Ox. Francês	50
69H					X	Niquel Mate	50

Refª	Diâmetro em mm					Acabamento	Imagem	
	12	15	18	20	24			
290	X	X	X	X		Niquel Mate	50	
			18	23	28	35		
Q054	X						Niquel Mate	
Q055		X	X				Niquel Mate	50
Q056	X						Niquel Mate	50
Q057				X	X		Niquel Mate	50

Puxadores em porcelana e plástico p/ móveis



Refª	Diâmetro em mm	Cores disponiveis			Imagem
		Branco / Branco c/ frizo azul - dourado - amarelo - cinzento	Branco / Branco c/ frizo azul - dourado - amarelo - cinzento	Branco / Branco c/ frizo azul - dourado - amarelo - cinzento	
437	25				50
437	32				50
437	38				50
836	38				50
41D	32				50

Refª	Diâmetro em mm	Cores disponiveis			Imagem
		Branco / Preto	Branco c/ frizo dourado	Niq.mate / Beje c/ frizo dourado	
110PL	35				50
111PD	35				50
671	35				50
771	35				50
771	35				50

Puxadores em latão p/ móveis



Refª	Diâmetro em mm	Acabamento			Imagem
		Latão Polido	Ox. Francês	Niquel Mate	
01	25	X	X	X	50
01	30	X	X	X	50
01	35	X	X	X	50
10	22	X	X	X	50
10	25	X	X	X	50
10	30	X	X	X	50

Refª	Diâmetro em mm	Acabamento			Imagem
		Latão Polido	Ox. Francês	Niquel Mate	
18	25	X	X	X	50
18	30	X	X	X	50
18	35	X	X	X	50
72	20	X	X	X	50
72	25	X	X	X	50

Puxador zamak

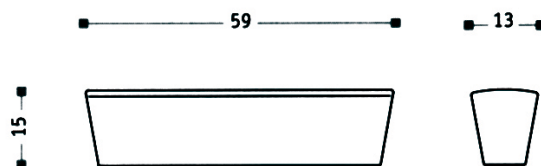

- 01 Cromado
- 03 Latonado
- 05 Bronze
- 06 Niquelado Preto
- 08 Lacado
- 10 Dourado
- 16 Niquelado Mate
- 17 Cromado Mate
- 23 Niquel escovado

Puxador zamak

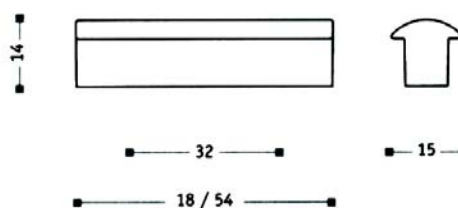

- 01 Cromado
- 03 Latonado
- 05 Bronze
- 06 Niquelado Preto
- 08 Lacado
- 10 Dourado
- 16 Niquelado Mate
- 17 Cromado Mate
- 23 Niquel escovado

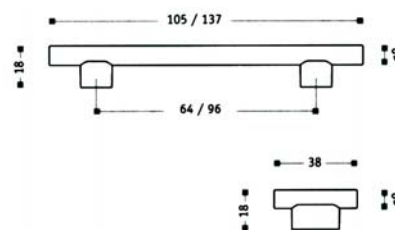
Puxador zamak

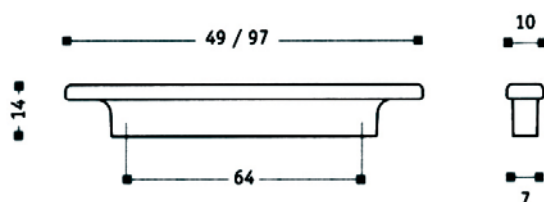

- 01 Cromado
- 03 Latonado
- 05 Bronze
- 06 Niquelado Preto
- 08 Lacado
- 10 Dourado
- 16 Niquelado Mate
- 17 Cromado Mate
- 23 Niquel escovado

Puxador zamak

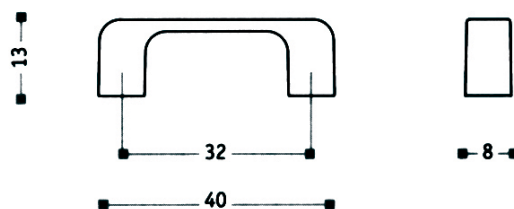

- 01 Cromado
- 03 Latonado
- 05 Bronze
- 06 Niquelado Preto
- 08 Lacado
- 10 Dourado
- 16 Niquelado Mate
- 17 Cromado Mate
- 23 Niquel escovado

Puxador zamak

- 01 Cromado
- 03 Latonado
- 05 Bronze
- 06 Niquelado Preto
- 08 Lacado
- 10 Dourado
- 16 Niquelado Mate
- 17 Cromado Mate
- 23 Niquel escovado

Puxador zamak

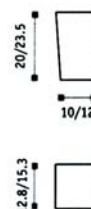
- 01 Cromado
- 03 Latonado
- 05 Bronze
- 06 Niquelado Preto
- 08 Lacado
- 10 Dourado
- 16 Niquelado Mate
- 17 Cromado Mate
- 23 Niquel escovado



Puxador zamak



Ref.ª 702
Fur. 96

- 01 Cromado
- 03 Latonado
- 05 Bronze
- 06 Niquelado Preto
- 08 Lacado
- 10 Dourado
- 16 Niquelado Mate
- 17 Cromado Mate
- 23 Niquel escovado

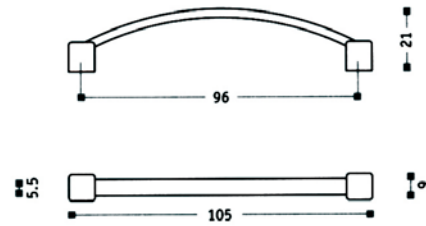

Puxador zamak



Ref.ª 703
Fur. 32

- 01 Cromado
- 03 Latonado
- 05 Bronze
- 06 Niquelado Preto
- 08 Lacado
- 10 Dourado
- 16 Niquelado Mate
- 17 Cromado Mate
- 23 Niquel escovado

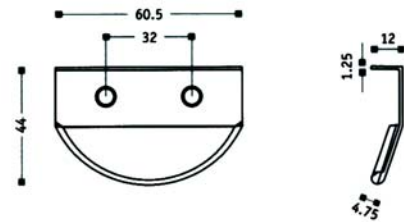

Puxador zamak



Ref.ª 705
Fur. 64

Ref.ª 704
Fur. 96

- 01 Cromado
- 03 Latonado
- 05 Bronze
- 06 Niquelado Preto
- 08 Lacado
- 10 Dourado
- 16 Niquelado Mate
- 17 Cromado Mate
- 23 Niquel escovado

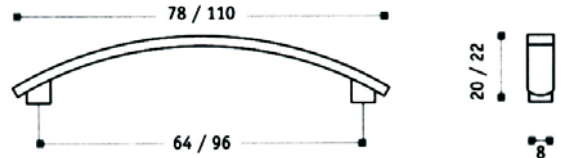

Puxador zamak



Ref.ª 708
Fur. 96

Ref.ª 707
Fur. 128

- 01 Cromado
- 03 Latonado
- 05 Bronze
- 06 Niquelado Preto
- 08 Lacado Preto
- 10 Dourado
- 16 Niquelado Mate
- 17 Cromado Mate
- 23 Niquel escovado

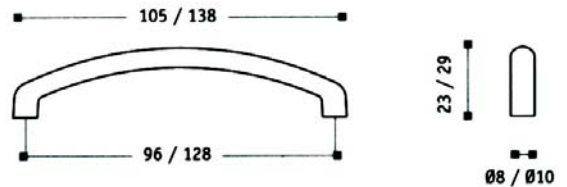

Puxador zamak



Ref.ª 721

- 01 Cromado
- 03 Latonado
- 05 Bronze
- 06 Niquelado Preto
- 08 Lacado
- 10 Dourado
- 16 Niquelado Mate
- 17 Cromado Mate
- 23 Niquel escovado

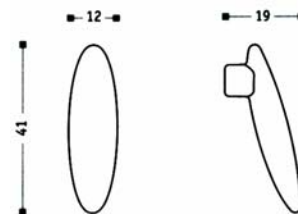

Puxador zamak



Ref.ª 722

Ref.ª 723

- 01 Cromado
- 05 Bronze
- 06 Niquelado Preto
- 08 Lacado
- 10 Dourado
- 11 Polido
- 16 Niquelado Mate
- 17 Cromado Mate
- 23 Niquel escovado

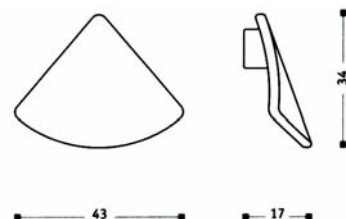

Puxador zamak



Ref.ª 772

- 01 Cromado
- 03 Latonado
- 05 Bronze
- 06 Niquelado Preto
- 08 Lacado
- 10 Dourado
- 16 Niquelado Mate
- 17 Cromado Mate
- 23 Niquel escovado

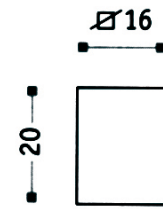

Puxador zamak



Ref.ª 773
Fur. 128

- 01 Cromado
- 03 Latonado
- 05 Bronze
- 06 Niquelado Preto
- 08 Lacado
- 10 Dourado
- 16 Niquelado Mate
- 17 Cromado Mate
- 23 Niquel escovado

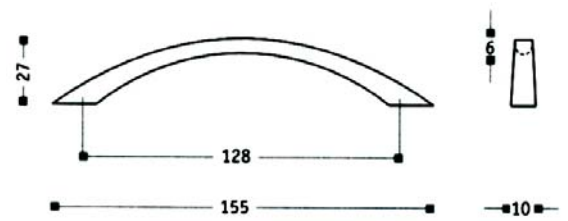

Puxador zamak



Ref.ª 774
Fur. 128

Ref.ª 775
Fur. 64

- 01 Cromado
- 03 Latonado
- 05 Bronze
- 06 Niquelado Preto
- 08 Lacado
- 10 Dourado
- 16 Niquelado Mate
- 17 Cromado Mate
- 23 Niquel escovado

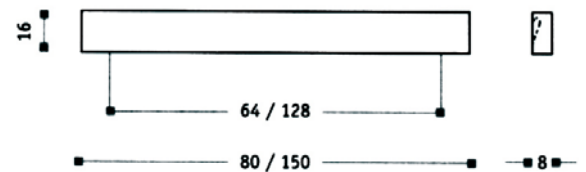

Puxador zamak



Ref.ª 776

- 01 Cromado
- 05 Bronze
- 06 Niquelado Preto
- 08 Lacado
- 10 Dourado
- 11 Polido
- 16 Niquelado Mate
- 17 Cromado Mate
- 23 Niquel escovado

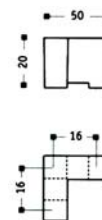

Puxador zamak



Ref.ª 777
Fur. 128

- 01 Cromado
- 05 Bronze
- 06 Niquelado Preto
- 08 Lacado
- 10 Dourado
- 11 Polido
- 16 Niquelado Mate
- 17 Cromado Mate
- 23 Niquel escovado

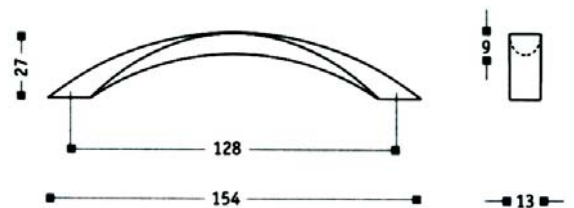

Puxador zamak



778D

Ref.ª 778
Fur. 32

778E

- 01 Cromado
- 05 Bronze
- 06 Niquelado Preto
- 08 Lacado
- 10 Dourado
- 11 Polido
- 16 Niquelado Mate
- 17 Cromado Mate
- 23 Niquel escovado

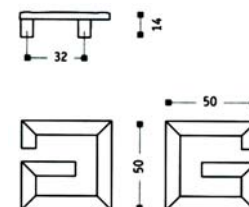

Puxador zamak

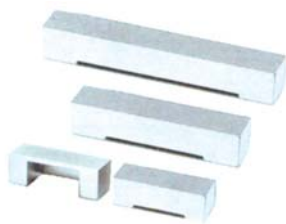

Ref.ª 790
Fur. 96

Ref.ª 791
Fur. 64

Ref.ª 792
Fur. 32

- 01 Cromado
- 03 Latonado
- 05 Bronze
- 06 Niquelado Preto
- 08 Lacado
- 10 Dourado
- 16 Niquelado Mate
- 17 Cromado Mate
- 23 Niquel escovado

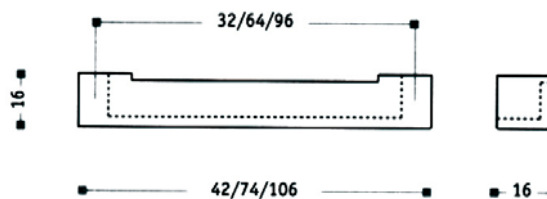

Puxador zamak



Ref.ª 793
Fur.64

Ref.ª 794
Fur.64

Ref.ª 795

- 01 Cromado
- 03 Latonado
- 05 Bronze
- 06 Niquelado Preto
- 08 Lacado
- 10 Dourado
- 16 Niquelado Mate
- 17 Cromado Mate
- 23 Niquel escovado

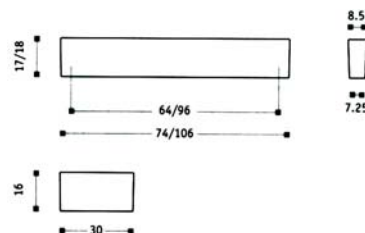

Puxador zamak



Ref.ª 796
Fur. 96

Ref.ª 797
Fur. 64

- 01 Cromado
- 03 Latonado
- 05 Bronze
- 06 Niquelado Preto
- 08 Lacado
- 10 Dourado
- 16 Niquelado Mate
- 17 Cromado Mate
- 23 Niquel escovado

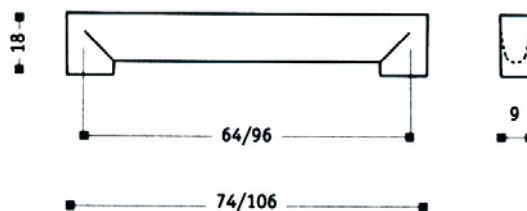

Puxador zamak



Ref.ª 798
Fur. 96

Ref.ª 799
Fur. 64

Ref.ª 800

- 01 Cromado
- 03 Latonado
- 05 Bronze
- 06 Niquelado Preto
- 08 Lacado
- 10 Dourado
- 16 Niquelado Mate
- 17 Cromado Mate
- 23 Niquel escovado

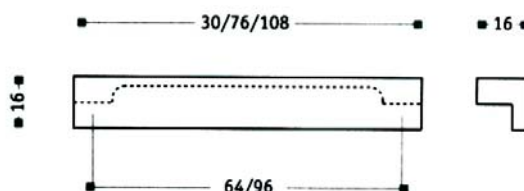

Puxador de latão



Ref.ª 330

- 01 Cromado
- 03 Latonado
- 05 Bronze
- 06 Niquelado Preto
- 08 Lacado
- 10 Dourado
- 16 Niquelado Mate
- 17 Cromado Mate



Puxador de latão



Ref.ª 331

- 01 Cromado
- 05 Bronze
- 06 Niquelado Preto
- 08 Lacado
- 10 Dourado
- 11 Polido
- 16 Niquelado Mate
- 17 Cromado Mate

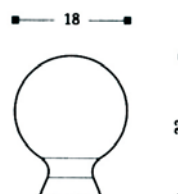

Puxador de latão

Ref.ª 334



Ref.ª 335

- 01 Cromado
- 05 Bronze
- 06 Niquelado Preto
- 08 Lacado
- 10 Dourado
- 16 Niquelado Mate
- 17 Cromado Mate

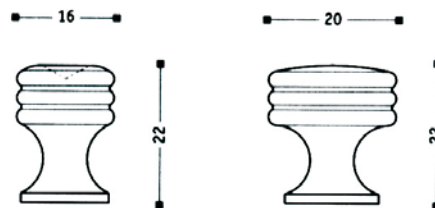
Puxador de latão

Ref.ª 336

- 01 Cromado
- 05 Bronze
- 06 Niquelado Preto
- 08 Lacado
- 10 Dourado
- 11 Polido
- 16 Niquelado Mate
- 17 Cromado Mate

Puxador de latão



Ref.ª 337

- 01 Cromado
- 05 Bronze
- 06 Niquelado Preto
- 08 Lacado
- 10 Dourado
- 11 Polido
- 16 Niquelado Mate
- 17 Cromado Mate

Puxador de latão

Ref.ª 990

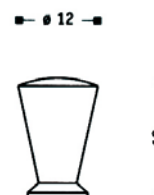
- 01 Cromado
- 03 Latonado
- 05 Bronze
- 06 Niquelado Preto
- 08 Lacado
- 10 Dourado
- 16 Niquelado Mate
- 17 Cromado Mate

Puxador de latão

Ref.ª 991

- 01 Cromado
- 03 Latonado
- 05 Bronze
- 06 Niquelado Preto
- 08 Lacado
- 10 Dourado
- 16 Niquelado Mate
- 17 Cromado Mate

Puxador de latão

Ref.ª 992

- 01 Cromado
- 03 Latonado
- 05 Bronze
- 06 Niquelado Preto
- 08 Lacado
- 10 Dourado
- 16 Niquelado Mate
- 17 Cromado Mate



Puxador de latão



Ref.ª 993

- 01 Cromado
- 05 Bronze
- 06 Niquelado Preto
- 08 Lacado
- 10 Dourado
- 11 Polido
- 16 Niquelado Mate
- 17 Cromado Mate

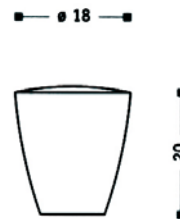

Puxador de latão



Ref.ª 996

Ref.ª 997

Ref.ª 995

- 01 Cromado
- 05 Bronze
- 06 Niquelado Preto
- 08 Lacado
- 10 Dourado
- 11 Polido
- 16 Niquelado Mate
- 17 Cromado Mate

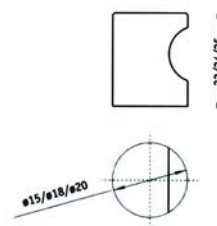

Puxador de latão



Ref.ª 998

- 01 Cromado
- 05 Bronze
- 06 Niquelado Preto
- 08 Lacado
- 10 Dourado
- 11 Polido
- 16 Niquelado Mate
- 17 Cromado Mate

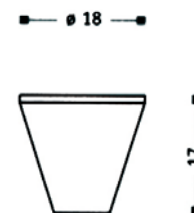

Puxador zamak



Ref.ª 784
Fur.160

- 01 Cromado
- 03 Latonado
- 05 Bronze
- 06 Niquelado Preto
- 08 Lacado
- 10 Dourado
- 16 Niquelado Mate
- 17 Cromado Mate
- 23 Niquel Escovado

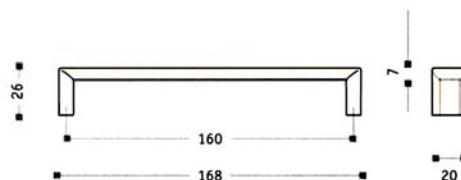

Puxador zamak



Ref.ª 786
Fur.160

- 01 Cromado
- 03 Latonado
- 05 Bronze
- 06 Niquelado Preto
- 08 Lacado
- 10 Dourado
- 16 Niquelado Mate
- 17 Cromado Mate
- 23 Niquel Escovado

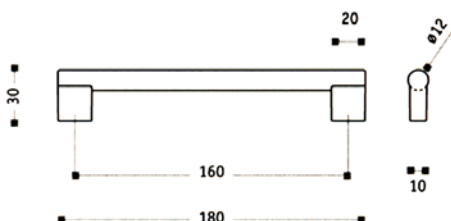

Puxador zamak



Ref.ª 788

- 01 Cromado
- 03 Latonado
- 05 Bronze
- 06 Niquelado Preto
- 08 Lacado
- 10 Dourado
- 16 Niquelado Mate
- 17 Cromado Mate
- 23 Niquel Escovado

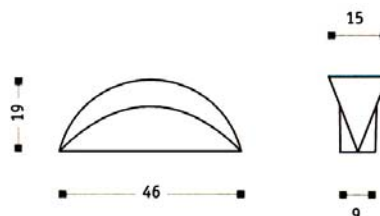

Asas / puxadores de zamak

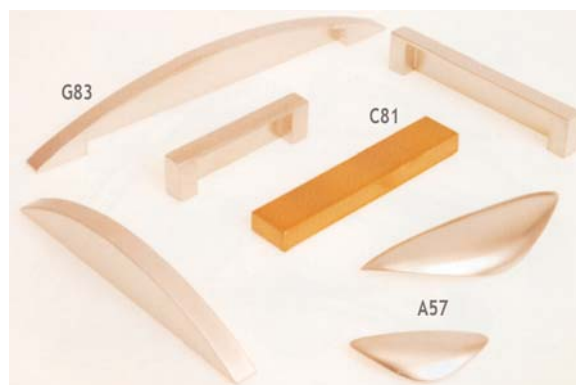
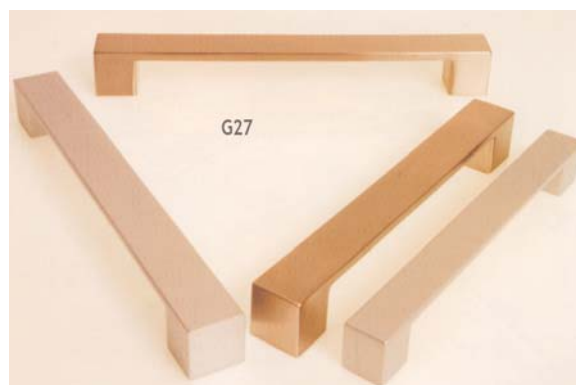
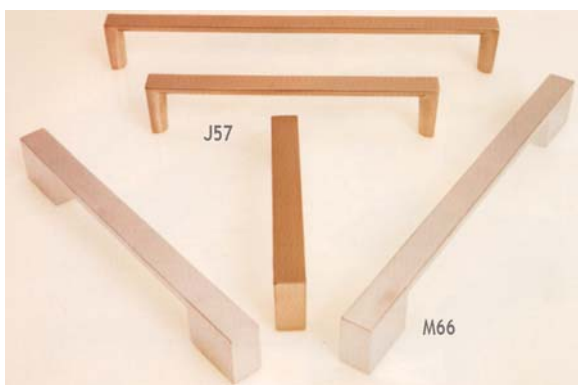
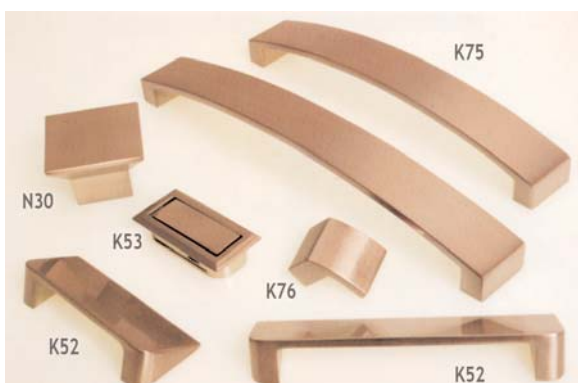
Asas de zamak

Asas de zamak

Asas / puxadores de zamak

Asas / puxadores de zamak

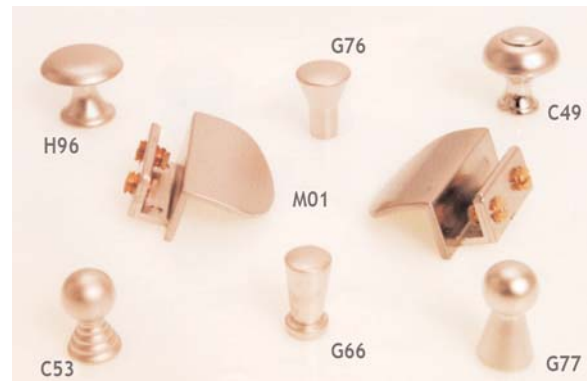

Puxadores de zamak



Asas / puxadores de zamak

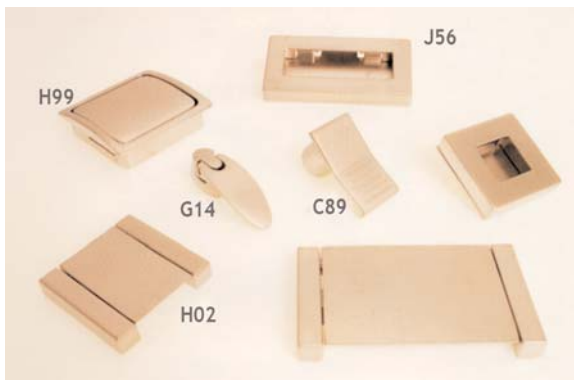

Asas de zamak



Asas / puxadores de zamak

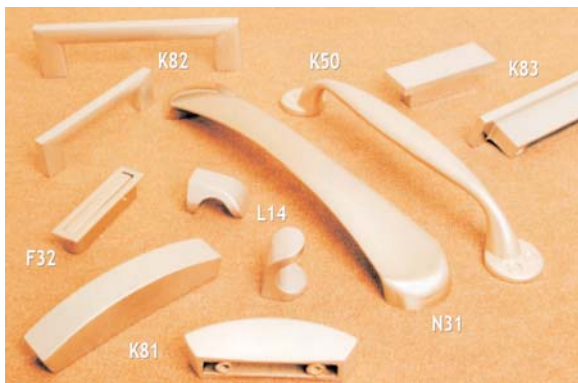

Puxadores de zamak

Puxadores de latão / zamak

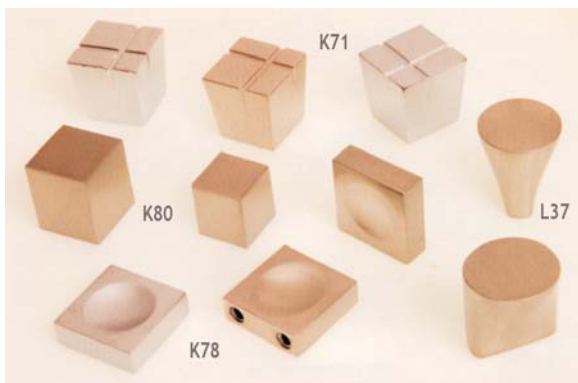

Asas de zamak

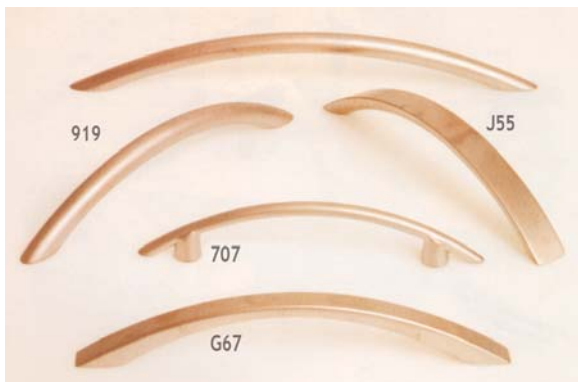

Asas de zamak

Asas / puxadores plástico

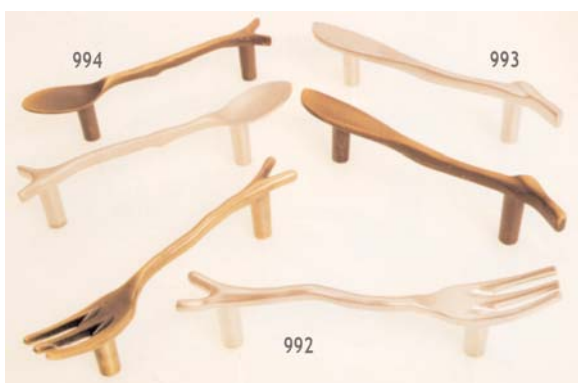

Asas de acrílico

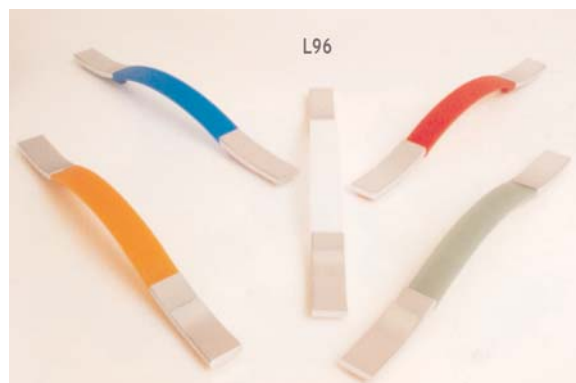
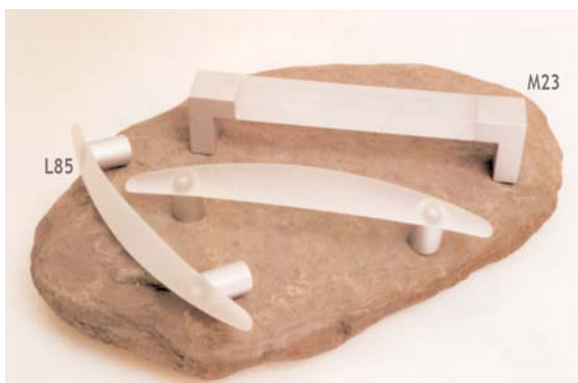

Asas / puxadores de cabedal e zamak

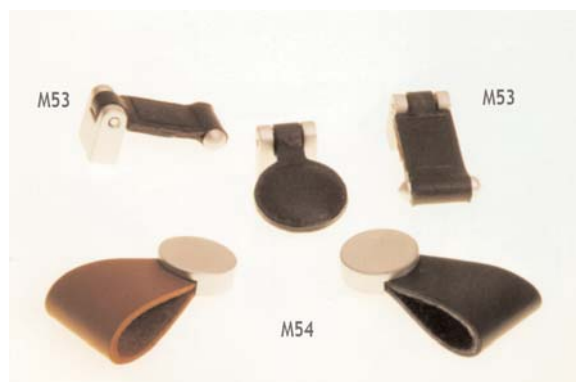

Asas / puxadores zamak e madeira



Puxadores de plástico



Puxadores de borracha e zamak



Suportes de prateleira

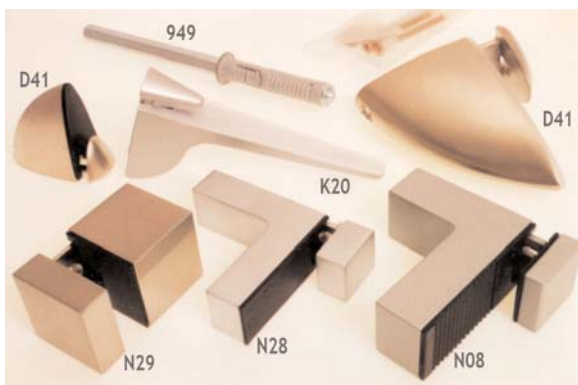

Sistemas de ligação

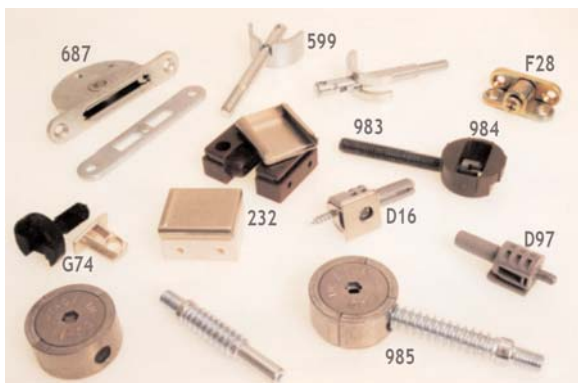

Sistemas de ligação



Esquadros de ligação

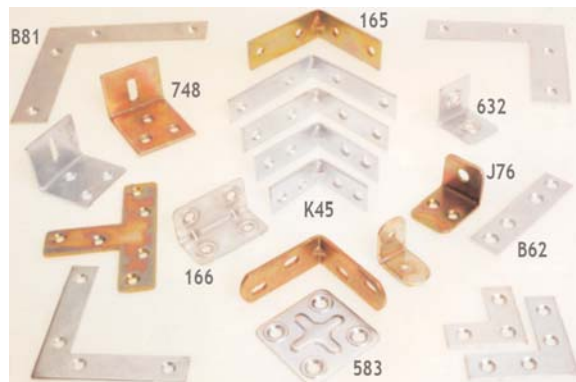

Acessórios plásticos / fechos



Abrasivos / dobradiças

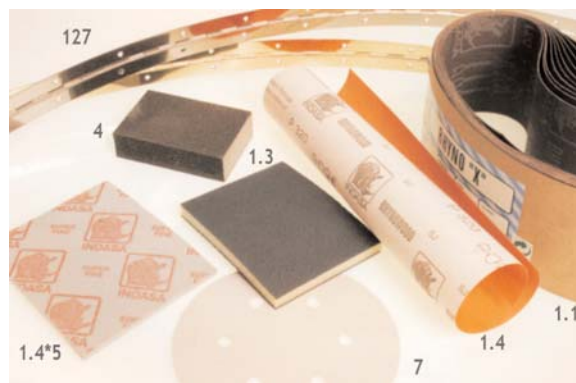

Parafusos / fita adesiva

Barras de cola quente



Pé de móvel zamak



Pé de móvel zamak

Pé de móvel alumínio

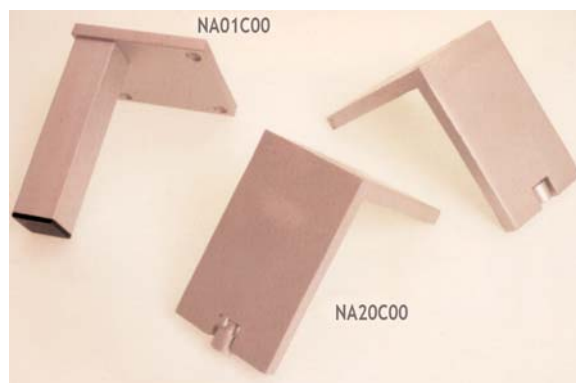
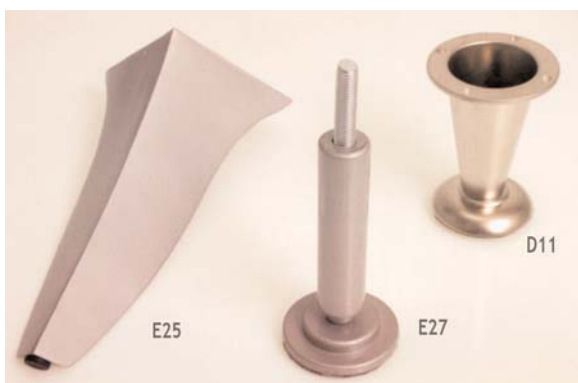

Pé ajustável zamak

Pé de móvel de plástico

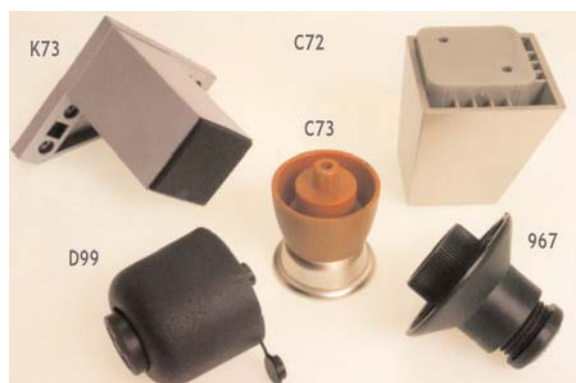

Puxadores em latão p/ móveis



Refª	Diâmetro Ø em mm	Acabamento			50
		Latão Polido	Ox. Françês	Niquel Mate	
P25	25	X	X	X	50
P25	30	X	X	X	50
P25	35	X	X	X	50
P80	25	X	X	X	50
P80	30	X	X	X	50
P80	35	X	X	X	50

Refª	Diâmetro Ø em mm	Acabamento			50
		Latão Polido	Ox. Françês	Niquel Mate	
105	15	X	X	X	50
105	18	X	X	X	50
105	20	X	X	X	50
71	30	X	X	X	50
71	35	X	X	X	50

Puxadores em latão p/ móveis



Refª	Diâmetro Ø em mm	Acabamento			50
		Latão Polido	Ox. Françês	Niquel Mate	
40	20	X	X	X	50
41	25	X	X	X	50
41	30	X	X	X	50
50	22	X	X	X	50
50	28	X	X	X	50

Refª	Diâmetro Ø em mm	Acabamento			50
		Latão Polido	Ox. Françês	Niquel Mate	
50	32	X	X	X	50
70	18	X	X	X	50
79	11	X	X	X	50
79	15	X	X	X	50

Puxadores em latão p/ móveis



Refª	Medida entre furos em mm			Acaba- -mento	50
	50	64	96		
Q031		X	X	Ox. Franc.	50
Q034		X	X	Ox. Franc.	50
Q036	X	X		Ox. Velho	50
Q032	Altura total em mm				
Q032	68		X	Ox. Franc.	50

Refª	Medida entre furos em mm			Acaba- -mento	50
	50	64	96		
Q033	110		X	Ox. Franc.	50
Q035	Diâmetro Ø em mm				
Q035	23		X	Ox. Franc.	50
Q035	32		X	Ox. Franc.	50
Q035	40		X	Ox. Franc.	50

Puxadores em latão p/ móveis



Refª	Medida entre furos em mm			Acaba- -mento	50
	48	56	74		
77			X	Ox. Franc.	50
90	X	X		Ox. Velho	50
91	X	X		Ox. Velho	50
92	Altura total em mm				
92	56		X	Ox. Franc.	50
93	82		X	Ox. Franc.	50

Refª	Medida entre furos em mm			Acaba- -mento	50
	48	56	74		
94	82		X	Ox. Franc.	50
95	80		X	Br. Velho	50
96	80		X	Br. Velho	50
97	40		X	Br. Velho	50
98	40		X	Br. Velho	50

Puxadores em latão p/ móveis



Refª	Medida entre furos em mm			Acaba- -mento	50
	68		85		
99	X		X	Ox. Franc.	50
101	X		X	Ox. Franc.	50
102	78	96		Br. Velho	50
103	64		90	Ox. Franc.	50
104	Altura total em mm				
104	52		X	Ox. Franc.	50

Refª	Medida entre furos em mm			Acaba- -mento	50
	68		85		
106	94		X	Ox. Franc.	50
119	112		X	Ox. Franc.	50
108	120		X	Ox. Franc.	50
109	45		X	Ox. Franc.	50
120	98		X	Ox. Franc.	50
114	124		X	Ox. Franc.	50

Puxadores em madeira p/ móveis



Refª	Diâmetro Ø em mm	CARVALHO				CASTANHO				50
		CV	CP	SV	SV SP	CV	CP	SV	SV SP	
A1	35	X			X					100
A2	40	X						X		100
A3	45	X								100
B1	28	X								100
B2	35	X	X	X	X	X				100
B3	40	X		X						100
H1	30	X	X	X	X	X	X			100
H2	35	X	X	X	X	X	X			100

Refª	Diâmetro Ø em mm	CARVALHO				CASTANHO				50
		CV	CP	SV	SV SP	CV	CP	SV	SV SP	
H3	40	X	X	X	X	X	X			100
M1	35	X	X	X	X	X	X			100
M2	40	X	X	X	X	X	X			100
M3	45	X		X						100
P1	30	X			X	X				100
P2	35	X	X	X	X	X			X	100
P3	45	X	X	X	X	X				100
I	35	X	X	X	X	X			X	100

Puxadores em madeira p/ móveis



Refª	Diâmetro Ø em mm	FAIA				FREIXO				Quantidade
		CV	CP	SV	SP	CV	CP	SV	SP	
A1	35									100
A2	40									100
A3	45									100
B1	28			X	X				X	100
B2	35	X	X	X					X	100
B3	40			X	X			X		100
H1	30	X	X	X		X	X	X		100
H2	35	X	X	X		X	X	X		100

Refª	Diâmetro Ø em mm	FAIA				FREIXO				Quantidade
		CV	CP	SV	SP	CV	CP	SV	SP	
H3	40	X	X	X		X	X	X		100
M1	35	X	X	X		X	X	X		100
M2	40	X	X	X		X	X	X		100
M3	45					X	X	X		100
P1	30									100
P2	35	X			X					100
P3	45	X								100
I	35				X				X	100

Puxadores em madeira p/ móveis

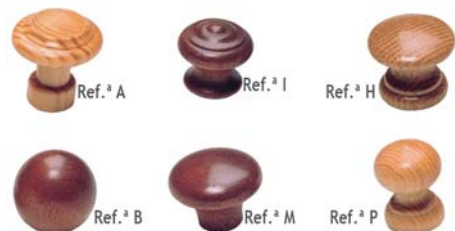

Refª	Diâmetro Ø em mm	MOGNO			PINHO			Quantidade
		CV	CP	SV	CV	CP	SV	
A1	35	X	X	X	X	X	X	100
A2	40	X	X	X	X	X	X	100
A3	45	X	X	X	X	X	X	100
B1	28	X	X	X	X	X	X	100
B2	35	X	X	X	X	X	X	100
B3	40	X	X	X	X	X	X	100
H1	30	X	X	X	X	X	X	100
H2	35	X	X	X	X	X	X	100

Refª	Diâmetro Ø em mm	MOGNO			PINHO			Quantidade
		CV	CP	SV	CV	CP	SV	
H3	40	X	X	X	X	X	X	100
M1	35	X	X	X	X	X	X	100
M2	40	X	X	X	X	X	X	100
M3	45	X	X	X	X	X	X	100
P1	30	X	X	X	X	X	X	100
P2	35	X	X	X	X	X	X	100
P3	45	X	X	X	X	X	X	100
I	35	X	X	X	X	X	X	100

Assas e lamelas em madeira p/ móveis



Refª	Med.entre furo em mm	MADEIRAS					Quantidade
		Carvalho	Castanho	Faia	Mogno	Pinho	
35		X	X	X	X	X	100
36	64			X			100
37	34			X	X	X	100
37	64						100
38	96	X					100

Refª	Med.entre furo em mm	MADEIRAS					Quantidade
		Carvalho	Castanho	Faia	Mogno	Pinho	
40	64						100
41	64	Asa c/ topos dourados ou cromados			X		100
L10				X			1000
L20				X			1000

Cavilhas em madeira p/ móveis



Refª	Diâmetro Ø em mm	Comprimento em mm	MADEIRAS		Quantidade
			Faia	Pinho	
C60	6	30	X	X	20000
C60	6	35	X	X	20000
C80	8	25		X	12000
C80	8	30	X	X	12000
C80	8	35	X	X	10000
C80	8	40	X	X	8000
C80	8	60	X	X	5000

Refª	Diâmetro Ø em mm	Comprimento em mm	MADEIRAS		Quantidade
			Faia	Pinho	
C100	10	35	X	X	5000
C100	10	40	X	X	5000
C100	10	45	X	X	5000
C100	10	50	X	X	5000
C100	10	60		X	5000
C100	10	70		X	5000

Balaustres em madeira p/ móveis

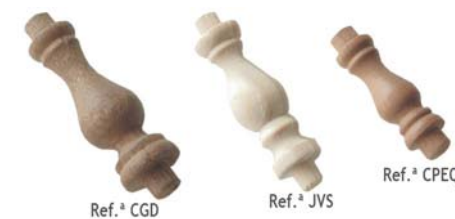

Refª	Medidas	MADEIRAS					Quantidade
		Carvalho	Castanho	Faia/Freixo	Mogno	Pinho	
CGD	10 x 58 x 73	X	X	X	X	X	100
CPEQ	10 x 43 x 57	X	X	X	X	X	100
JVS	8 x 52 x 68	X	X	X	X	X	100

Betume para madeira

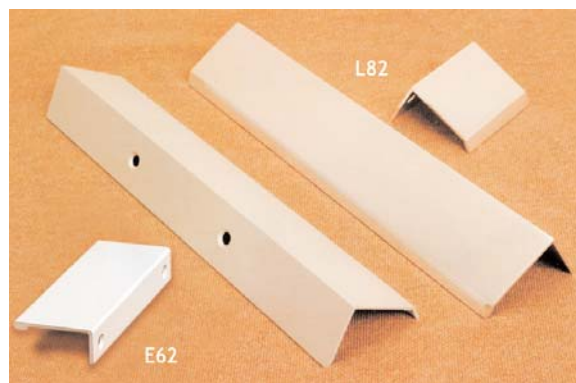
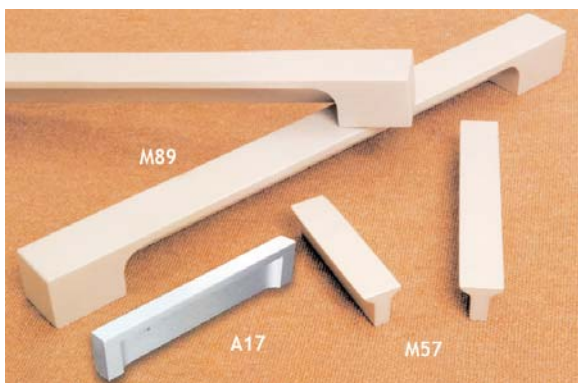
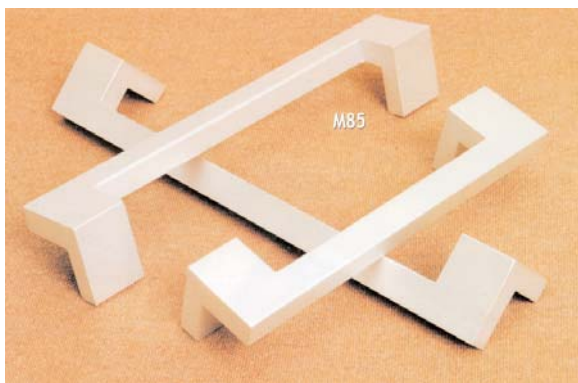
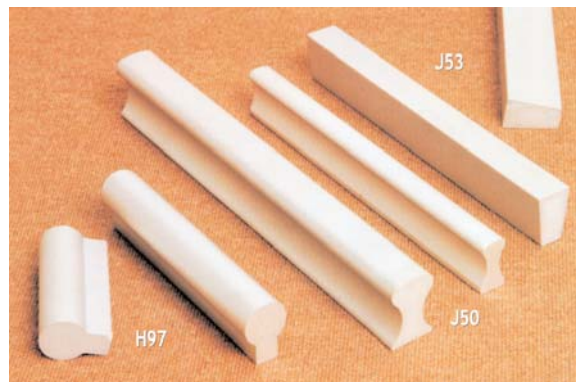
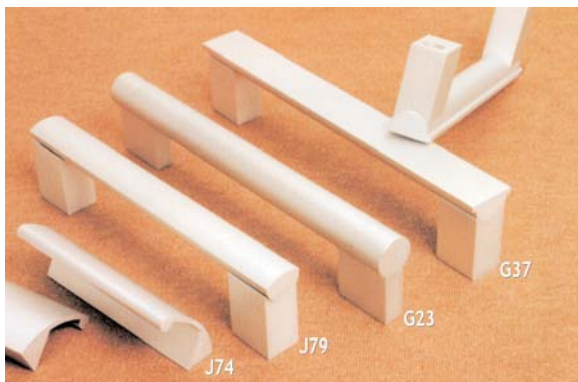
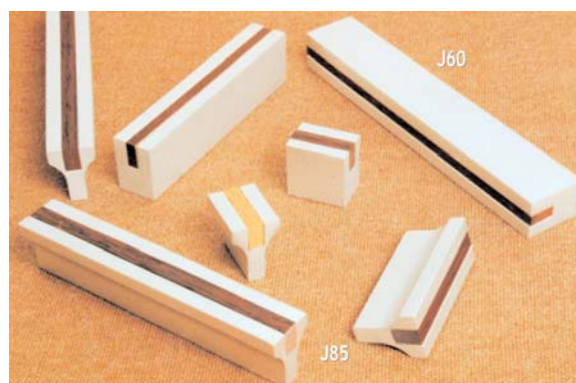

Refª	Cores disponíveis	Quantidade
BAKAR	Branco / Carvalho / Castanho Emberbo / Faia / Mogno / Pinho Natural / Nogueira / Preto / Teka	25

Asas de alumínio

Asas de alumínio

Asas de alumínio

Asas / puxadores de alumínio

Módulo com cesto em pano e garrafeira

Módulo cesto para verduras



Auto cierre

CESTO BOTELLERO PANERO EXTRACCIÓN TOTAL
módulo com cesto em pano e garrafeira

REFERENCIA referencia	20030014	REFERENCIA referencia	20040014
MODULO modulo	30 cm	MODULO modulo	40 cm
CAJA caixa	1 und	CAJA caixa	1 und

MEDIDAS medidas A. 209-B. 446-C. 467

MEDIDAS medidas A. 309-B. 446-C. 467

MEDIDAS medidas (mm)



Auto cierre

CESTO VERDULERO EXTRACCIÓN TOTAL
módulo cesto para verduras

REFERENCIA referencia	20130014	REFERENCIA referencia	20230014
MODULO modulo	30 cm	MODULO modulo	30 cm
CAJA caixa	1 und	CAJA caixa	8 unds

MEDIDAS medidas A. 209-B. 446-C. 467

REFERENCIA referencia 20140014

MODULO modulo	40 cm
CAJA caixa	1 und

MEDIDAS medidas A. 309-B. 446-C. 467

MEDIDAS medidas (mm)



CESTO COLGANTE VERDULERO
módulo cesto para verduras suspenso

REFERENCIA referencia	20240014
MODULO modulo	40 cm
CAJA caixa	8 unds

MEDIDAS medidas A. 309-B. 421-C. 180

MEDIDAS medidas (mm)



Módulo cesto garrafeira

Cesto caçaroleiro



Auto cierre

CESTO BOTELLERO EXTRACCIÓN TOTAL
módulo cesto garrafeira

REFERENCIA referencia	20415024 drcha
MODULO modulo	15 cm
CAJA caixa	1 und

MEDIDAS medidas A. 97-B. 495-C. 463

REFERENCIA referencia 20415034 izq

MODULO modulo	1 und
CAJA caixa	15 cm

MEDIDAS medidas A. 97-B. 495-C. 463

MEDIDAS medidas (mm)



Auto cierre

CESTO CACEROLEIRO EXTRACCIÓN TOTAL
cesto caçaroleiro extracção total

REFERENCIA referencia	20745024
MODULO modulo	45 cm
CAJA caixa	2 unds

MEDIDAS medidas A. 374-B. 490-C. 150

REFERENCIA referencia 20760024

MODULO modulo	60 cm
CAJA caixa	2 unds

MEDIDAS medidas A. 524-B. 490-C. 150

REFERENCIA referencia 20790014

MODULO modulo	90 cm
CAJA caixa	2 unds

MEDIDAS medidas A. 824-B. 490-C. 150

MEDIDAS medidas (mm)



Porta calças extraível

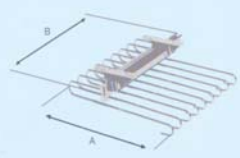

PANTALONERO EXTRAÍVEL EXT.TOTAL
porta calças extraível

REFERENCIA referencia	05600407	MEDIDAS medidas(mm)	
CAJA caixa	1 und		
PALE paleta	120 unds	REFERENCIA referencia	05600507
MEDIDAS medidas	A. 350-B. 366-C. 110	CAJA caixa	1 und
		PALE paleta	96 unds
		MEDIDAS medidas	A. 350-B. 466-C. 110

Porta calças duplo extraível



PANTALONERO DOBLE EXTRAÍVEL EXT.TOTAL
porta calças duplo extraível

REFERENCIA referencia	06200363	MEDIDAS medidas(mm)	
CAJA caixa	1 und		
PALE paleta	72 unds	REFERENCIA referencia	06200463
MEDIDAS medidas	A. 368-B. 650-C. 60	CAJA caixa	1 und
		PALE paleta	60 unds
		MEDIDAS medidas	A. 468-B. 650-C. 60

Porta calças abatível



PANTALONERO ABATIBLE
portacalças abatível

REFERENCIA referencia	05700453	MEDIDAS medidas(mm)	
CAJA caixa	1 und		
PALE paleta	160 unds	REFERENCIA referencia	05800453
MEDIDAS medidas	A. 507-B. 220	CAJA caixa	1 und
		PALE paleta	160 unds
		MEDIDAS medidas	507 mm



PORTAFALDAS ABATIBLE
portafaldas abatível

REFERENCIA referencia	05800453	MEDIDAS medidas(mm)	
CAJA caixa	1 und		
PALE paleta	160 unds	REFERENCIA referencia	05800453
MEDIDAS medidas	507 mm	CAJA caixa	1 und
		PALE paleta	160 unds
		MEDIDAS medidas	507 mm

Sapateira extensível ext. parcial



*Fondo mínimo 475 mm
*Incluye juego de guías y escuadras
* Incluye jogo de guias e escuadras



ZAPATEIRO EXTENSÍVEL EXTRAÇÃO PARCIAL
sapateira extensível extração parcial

REFERENCIA <i>referencia</i>	CAJA <i>caixa</i>	MEDIDAS <i>medidas</i>
05300407	2 unds	A. 466, B. 400-600 mm
05300507	2 unds	A. 466, B. 500-800 mm
05300607	2 unds	A. 466, B. 600-1000 mm

Sapateira extensível ext. total



*Fondo mínimo 492 mm
*Incluye juego de guías y escuadras
* Incluye jogo de guias e escuadras



ZAPATEIRO EXTENSÍVEL EXTRAÇÃO TOTAL
sapateira extensível extração total

REFERENCIA <i>referencia</i>	CAJA <i>caixa</i>	MEDIDAS <i>medidas</i>
05400407	2 unds	A. 466, B. 400-600 mm
05400507	2 unds	A. 466, B. 500-800 mm
05400607	2 unds	A. 466, B. 600-1000 mm

Porta camisas



REF <i>REF</i>	MEDIDAS <i>SIZES</i>
05000307	Fondo/Depth - 300 mm
05000357	Fondo/Depth - 350 mm
05000407	Fondo/Depth - 400 mm
05000457	Fondo/Depth - 450 mm

Porta camisas



REF <i>REF</i>	MEDIDAS <i>SIZES</i>
05100457	450 - 600 mm
05100607	600 - 830 mm
05100837	830 - 1150 mm

Sapateiras / Calceiros / Cabides e Gravateiros



Refª	Descrição	
S615	Sapateira extraível lateral com duas prateleiras prateada 320 x 500 x 502	1
S714	Sapateira extraível lateral com três prateleiras prateada 320 x 500 x 790	1



Refª	Medida em mm	Descrição	
C117	480 x 525 x 75	Calceiro extraível prateado	1
C117	720 x 525 x 75	Calceiro extraível prateado	1
T770		Tabuleiro p/ chaves moedas canetas etc...	1



Refª	Medidas em mm	Descrição	
C018	90 x 475 x 175	Cabide extraível prateado	1

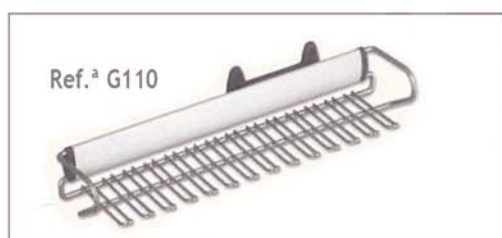

Refª	Medidas em mm	Descrição	
G110	145 x 500 x 100	Gravateiro extraível prateado	1

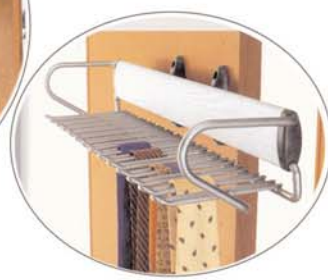

Sapateiras / Calceiros / Camiseiros e Gravateiros



Refª	Descrição	
3102	Sapateira extraível lateral com duas prateleiras cromada 280 x 470 x 250 mm	1
3104	Sapateira extraível lateral com quatro prateleiras cromada 550 x 470 x 250 mm	1



Refª	Medida em mm	Descrição	
3450	400 a 600 x 445	Sapateira extraível largura regulavel cromada	2
3500	500 a 800 x 445	Sapateira extraível largura regulavel cromada	2
3360	600 a 1000 x 445	Sapateira extraível largura regulavel cromada	2



Refª	Medidas em mm	Descrição	
3008	370 x 350 x 120	Calceiro Cromado com 9 barras	2
3010	470 x 350 x 120	Calceiro Cromado com 11 barras	2



Refª	Medidas em mm	Descrição	
C118	255 x 560 x 220	Calceiro Cromado Lateral	1



Refª	Medidas em mm	Descrição	
3017	250 300 400	X 40 X 60 Cabide trombone Cromado	20
3017	450 500	X 40 X 60 Cabide trombone Cromado	20

Carro multiusos c/ amortecedor



Ref.ª EGS200

Ref.ª EGS300



Ref.ª EGS400

Refª	Modulo em mm	Largura em mm	Comp. em mm	Altura em mm	COR	
EGS200	200	150	425	457	AÇO INOX	1
EGS300	300	250	425	507	AÇO INOX	1
EGS400	400	350	425	507	AÇO INOX	1

Gavetas c/ amortecedor



Ref.ª EG8600



Ref.ª EG7600

Refª	Modulo em mm	Largura em mm	Comp. em mm	Altura em mm	COR	
EG7600	600	566	425	155	AÇO INOX	1
EG7900	900	866	425	155	AÇO INOX	1
EG8600	600	566	425	150	AÇO INOX	1
EG8900	900	866	425	150	AÇO INOX	1

Gaveta de arame c/ fixação de frente



Refª	Modulo em mm	Largura em mm	Comp. em mm	Altura em mm	COR	
E-4611	400	365	480	120	Cromado	2
E-4612	450	415	480	120	Cromado	2
E-4613	500	465	480	120	Cromado	2
E-4614	600	565	480	120	Cromado	2
E-4617	900	865	480	120	Cromado	2

Gaveta de arame



Refª	Modulo em mm	Largura em mm	Comp. em mm	Altura em mm	COR	
E-4511	400	365	475	120	Cromado	2
E-4512	450	415	475	120	Cromado	2
E-4513	500	465	475	120	Cromado	2
E-4514	600	565	475	120	Cromado	2
E-4515	700	665	475	120	Cromado	2
E-4516	800	765	475	120	Cromado	2

Porta tachos



Ref ^a	Modulo em mm	Largura em mm	Comp. em mm	Altura em mm	COR	
17-60	600	563	430	160	Cromado	4
17-90	900	863	430	160	Cromado	4

Carro com cesto do pão



Ref ^a	Modulo em mm	Largura em mm	Comp. em mm	Altura em mm	COR	
EPT320	320	269	475	520	Cromado	1
EPT420	420	369	475	520	Cromado	1

Carro multiusos c/ Amortecedores



Ref.^a EPT150



Ref.^a EKA215



Ref.^a EKA300



Ref.^a EKA350



Ref.^a EKA400

Ref ^a	Modulo em mm	Largura em mm	Comp. em mm	Altura em mm	COR	
EPT150	150	115	475	510	Cromado	2
EKA215	215	170	455	450	Cromado	1
EKA300	300	245	400	495	Cromado	1
EKA350	350	300	470	465	Cromado	1
EKA400	400	360	455	510	Cromado	1

Carro multiusos



Ref.ª E-C35



Ref.ª E-C40



Ref.ª E-C45

Ref. ^ª	Modulo em mm	Largura em mm	Comp. em mm	Altura em mm	COR	
E-C35	350	290	435	496	Cromado	1
E-C40	400	345	455	536	Cromado	1
E-C45	450	395	455	546	Cromado	1

Cesto giratório 3/4 em arame



Ref. ^ª	Diametro Ø em mm	COR	
EPT-700	700	Cromado	1
EPT-820	820	Cromado	1

Utensílios de cozinha p/ varão e protector de placas



Ref.ª E6061



Ref.ª E6077



Ref.ª E6069



Ref.ª E6065

Ref. ^ª	Descrição	COR	
E6061	Cesto de pendurar	Cromado	1
E6065	Suporte triplo p/ rolos	Cromado	1
E6069	Estante p/ livro de culinária	Cromado	1
E6077	Cesto de canto de pendurar	Cromado	1



Ref.ª E6076



Ref.ª E6051

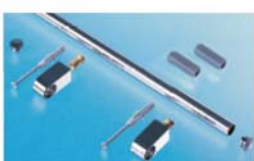

Ref.ª E6001



Ref.ª E4911

Ref. ^ª	Descrição	COR	
E6001	Conj. C/ 2 conj. Fixação +1 Varão c/1200 mm + 2 Terminais	Cromado	1
E6051	Gancho Simples	Cromado	20
E6052	Gancho Duplo	Cromado	10
E6076	Porta Especiarias	Cromado	1
E4911	Protector p/placas de fogão	Cromado	1

Canto mágico giratório



Refª	Modulo em mm	Profund. em mm	Largura em mm	Lado	
E-4209	900	495	865	Esquerdo	1
E-4210	900	495	865	Direito	1
ACABAMENTO CROMADO					

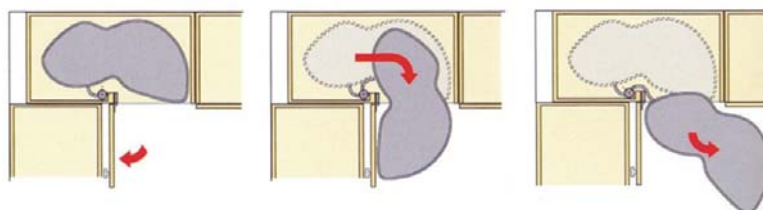

Mecanismo elevador p/ móvel superior



Refª	Modulo em mm	Profund. em mm	Largura em mm	Altura em mm	
E-4211	900	280	860	650	1
ACABAMENTO CROMADO					

Canto mágico c/ amortecedor

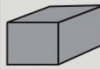

Refª	Modulo em mm	Profund. em mm	Altura em mm	Porta em mm	Lado	
E-4027	900	500	550	450	Esquerdo	1
E-4028	900	500	550	450	Direito	1
ACABAMENTO CROMADO						

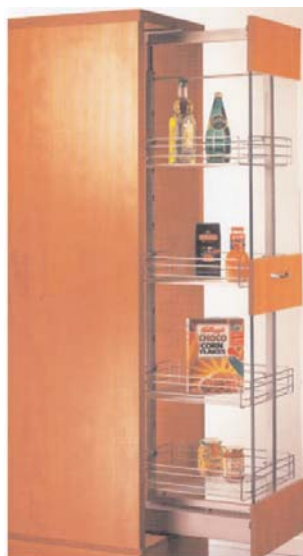
Despenseiro



ESTRUTURA DE DESPENSEIRO					
Refª	Altura Min. em mm	Altura Max. em mm	COR		
900	650	950	Branco	Prateada	1
901	950	1200	Branco	Prateada	1

CESTO PARA DESPENSEIRO						
Refª	Modulo em mm	Largura em mm	Comp. em mm	Altura em mm	COR	
E-250	300	250	460	85	Cromado	5
E-350	400	350	460	85	Cromado	5
E-450	500	450	460	85	Cromado	5
E-550	600	550	460	85	Cromado	5

Despenseiro até 100 Kg de peso



DESPENSEIRO COMPLETO						
Refª	Modulo em mm	Largura em mm	Altura em mm	COR	Nº Cestos	
E-4005	300	250	1320 - 1720	CROMADO	4	1
E-4004	400	350	1620 - 2020	CROMADO	5	1
E-4020	400	350	1820 - 2220	CROMADO	6	1
E-4011	450	400	1820 - 2220	CROMADO	6	1
E-4012	500	450	1820 - 2220	CROMADO	6	1
E-4013	600	550	1820 - 2220	CROMADO	6	1

Despenseiro até 50 Kg de peso

DESPENSEIRO COMPLETO						
Refª	Modulo em mm	Largura em mm	Altura em mm	COR	Nº Cestos	
E-4073	400	350	1320 - 1720	CROMADO	4	1
E-4063	400	350	1620 - 2020	CROMADO	5	1
E-4053	400	350	1820 - 2220	CROMADO	6	1
E-4054	450	400	1820 - 2220	CROMADO	6	1
E-4055	500	450	1820 - 2220	CROMADO	6	1

Porta tachos

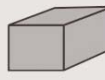

Refª	Modulo em mm	Largura em mm	Comp. em mm	Altura em mm	COR	
16-60	600	570	500	200	Cromado	1
16-90	900	870	500	200	Cromado	1

Cesto giratório 3/4 em arame



Refª	Diametro dos cestos Ø em mm	COR	
EC 734	715	CROMADO	1

Canto mágico

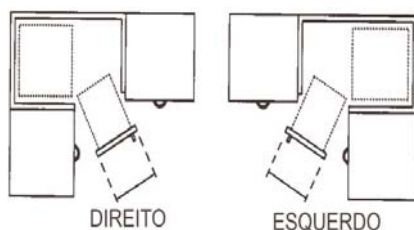

Refª	Modulo em mm	Profund. em mm	Altura em mm	Porta em mm	Lado	
E-4201	900	500	550	450	Direito	1
E-4202	900	500	550	450	Esquerdo	1
ACABAMENTO CROMADO						

Canto mágico

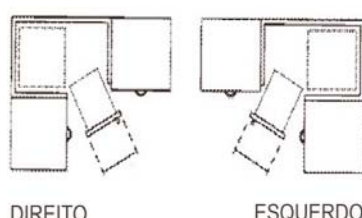

Refª	Modulo em mm	Profund. em mm	Altura em mm	Porta em mm	Lado	
E-4203	800	470	515	400	Esquerdo	1
E-4204	800	470	515	400	Direito	1
ACABAMENTO CROMADO						

Carro multiusos c/ amortecedor





Refª	Modulo em mm	Largura em mm	Comp. em mm	Altura em mm	COR	
EKA400	400	360	455	510	Cromado	1

Carro multiusos lateral

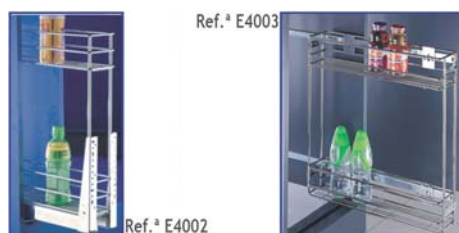

Refª	Modulo em mm	Largura em mm	Comp. em mm	Altura em mm	COR	
25-40	400	345	505	535	Cromado	1
25-60	600	545	505	535	Cromado	1

Porta garrafas

Ref ^a	Modulo em mm	Largura em mm	Comp. em mm	Altura em mm	COR	
E-4002	150	110	445	530	Cromado	1
E-4003	150	110	465	485	Cromado	1

Porta garrafas

Ref ^a	Modulo em mm	Largura em mm	Comp. em mm	Altura em mm	COR	
E-C30	300	240	445	535	Cromado	1
E-C45	450	385	455	515	Cromado	1

Cesto giratório 4/4 em arame

Ref ^a	Diametro Ø em mm	COR	
EC4-460	460	Cromado	1
EC4-610	610	Cromado	1
EC4-710	710	Cromado	1

Cesto giratório 3/4 em arame

Ref ^a	Diametro Ø em mm	COR	
EC3-720	720	Cromado	1
EC3-820	820	Cromado	1

Cesto giratório 2/4 em arame

Ref ^a	Diametro Ø em mm	COR	
EC2-845	845	Cromado	1

Cesto giratório 2/4 em arame



Ref ^a	Diametro Ø em mm	COR	
EC2-675	675	Cromado	2
EC2-770	770	Cromado	2

Cesto giratório 2/4 em arame e plástico

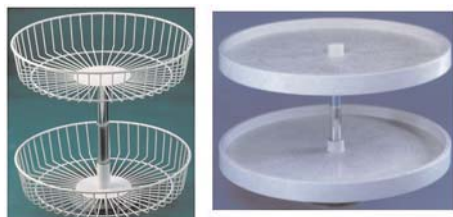

Refª	Diametro Ø em mm	Cor Branco	Cor Cromado	Plástico Branco	
654	650	X	X	X	1
654	750	X	X	X	1
654	850	X	X	X	1

Cesto giratório 4/4 em arame



Refª	Diametro Ø em mm	Preço unidade Cor Branco	Preço unidade Cor Cromado	Preço unidade Plástico Branco		Refª	Diametro Ø em mm	Preço unidade Cor Branco	Preço unidade Cor Cromado	Preço unidade Plástico Branco	
370	380	X			1	370	620	X			1
370	460	X			1	370	720	X	X	X	1
370	520	X			1	370	820	X	X	X	1

Cesto giratório 3/4 em arame e plástico



Refª	Diametro Ø em mm	COR		Refª	Diametro Ø em mm	COR	
938	720	Plástico Branco	1	938	720	Lacado Branco	1
938	820	Plástico Branco	1	938	820	Lacado Branco	1

Tulha com corredeiras



Refª	Modulo em mm	Largura em mm	Comp. em mm	Altura em mm	COR	
25-40	400	345	505	535	Cromado	1
25-60	600	545	505	535	Cromado	1

Tulha em arame

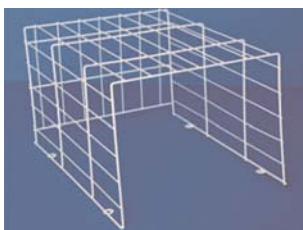

Refª	Largura em mm	Comp. em mm	Altura em mm	COR		Refª	Largura em mm	Comp. em mm	Altura em mm	COR	
T-25	250	420	250	Branco	5	T-36	365	420	250	Branco	5
T-28	285	420	250	Branco	5	T-41	410	420	250	Branco	5
T-32	325	420	250	Branco	5	T-44	440	420	250	Branco	5

Dobradiça c/ amortecedor em ferro niquelado



Refª	Medida do copo Ø mm		Refª	Medida do copo Ø mm	
616	35	100	618	35	100
617	35	100	619	35	100

Gaveta plástica com corredeiras metálicas





Refª	Modulo em mm	Largura em mm	Comp. em mm	Altura em mm	COR	
G-430	300	270	450	100	Beje	16
G-435	350	320	450	100	Beje	16
G-440	400	370	450	100	Beje	16

Refª	Modulo em mm	Largura em mm	Comp. em mm	Altura em mm	COR	
G-445	450	420	450	100	Beje	16
G-450	500	470	450	100	Beje	16
G-460	600	570	450	100	Beje	16

Gaveta plástica com corredeiras plásticas



Refª	Modulo em mm	Largura em mm	Comp. em mm	Altura em mm	COR	
G-930	300	267	435	100	Branco	16
G-935	350	317	435	100	Branco	16
G-940	400	367	435	100	Branco	16

Refª	Modulo em mm	Largura em mm	Comp. em mm	Altura em mm	COR	
G-945	450	417	435	100	Branco	16
G-950	500	467	435	100	Branco	16
G-960	600	567	435	100	Branco	16

Gaveta plástica com corredeiras plásticas



Refª	Modulo em mm	Largura em mm	Comp. em mm	Altura em mm	COR	
G-860	300	270	440	80	Branco	25
G-863	350	320	440	80	Branco	25
G-866	400	370	440	80	Branco	25

Refª	Modulo em mm	Largura em mm	Comp. em mm	Altura em mm	COR	
G-862	450	420	440	80	Branco	25
G-865	500	470	440	80	Branco	25
G-864	600	570	440	80	Branco	25

Cesto de verga com corredeira de madeira



Refª	Modulo em mm	Largura em mm	Comp. em mm	Altura em mm	
G-867	400	370	450	205	5
G-868	450	420	450	205	5
G-869	500	470	450	205	5

Refª	Modulo em mm	Largura em mm	Comp. em mm	Altura em mm	
G-870	550	520	450	205	5
G-871	600	570	450	205	5

Gaveta plástica com corredeiras dynamic





Refª	Modulo em mm	Largura em mm	Comp. em mm	Altura em mm	COR	
G-630	300	260	450	90	Beje	10
G-640	400	360	450	90	Beje	10
G-645	450	410	450	90	Beje	10

Refª	Modulo em mm	Largura em mm	Comp. em mm	Altura em mm	COR	
G-650	500	460	450	90	Beje	10
G-655	550	510	450	90	Beje	10
G-660	600	560	450	90	Beje	10

Grade cromada para gaveta plástica



Refª	Modulo em mm	COR	
G-730	300	Cromado	10
G-740	400	Cromado	10
G-745	450	Cromado	10

Refª	Modulo em mm	COR	
G-750	500	Cromado	10
G-755	550	Cromado	10
G-760	600	Cromado	10

Gavetas com duplo porta talheres



Refª	Modulo em mm	Largura em mm	Comp. Em mm	Altura em mm	COR	
418	450	418	480	90	Beje	10
468	500	468	480	90	Beje	10
568	600	568	480	90	Beje	10

Porta talheres



Refª	Modulo em mm	Largura Min. em mm	Largura Max. em mm	Comp. em mm	COR	
P430	300-350	201	299	446	Beje	25
P440	400-450	301	399	446	Beje	18
P445	500-550	401	499	446	Beje	15
P460	600	501	559	446	Beje	12
P530	300-350	201	299	496	Beje / cinza	25
P540	400-450	301	399	496	Beje / cinza	18

Refª	Modulo em mm	Largura Min. em mm	Largura Max. em mm	Comp. em mm	COR	
P545	450	350	399	496	Beje / cinza	18
P550	500-550	401	499	496	Beje / cinza	15
P560	600	501	559	496	Beje / cinza	12
P580	800	700	760	540	Cinza	10
P590	900	795	859	540	Cinza	10

Baldes de lixo ecológicos para cozinha



Refª	Modulo em mm	Descrição	Capacidade	
B901	600	Kit 3 Baldes para Gavetão	1 Balde 16 2 Baldes 7,5 litros	1

Refª	Modulo em mm	Descrição	Capacidade	
B906	900	Kit 3 Baldes para Gavetão	3 Baldes 14 litros	1

Baldes de lixo ecológicos para cozinha



Refª	Modulo em mm	Descrição	
B907	900	Kit 2 baldes P/ Gavetão 14 litros cada	1

Refª	Modulo em mm	Descrição	
B909	1200	Kit 3 baldes P/ Gavetão 14 litros cada	1

Baldes de lixo ecológicos para cozinha



Refª	Modulo em mm	Descrição	COR	
B240	350	2 Baldes c/ corrediça 14 litros cada	Branco	1

Refª	Modulo em mm	Descrição	COR	
B890	350	2 Baldes c/ corrediça 14 litros cada	Cinza	1

Baldes de lixo ecológicos para cozinha



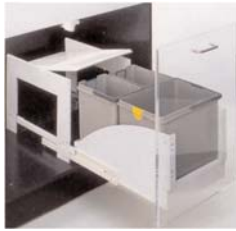

Refª	Modulo em mm	Descrição	
B610	500	Kit de 3 baldes	1

Refª	Modulo em mm	Descrição	
B620	500	Kit de 4 baldes	1

Baldes de lixo p/ cozinha em aço inox / aço lac. e plástico

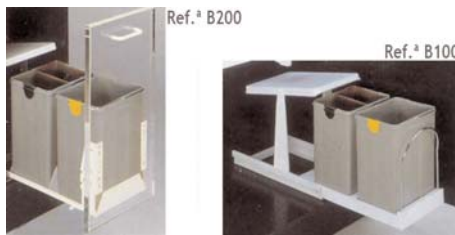

Refª	Modulo em mm	Descrição	Cores	
B322	400	Balde com correção extensível e esquadros reguláveis	Tampa plást. Branco Corpo plást. Cinza	1
Capacidade - 1 Balde de 18 lt. e 2 de 8 lt.				

Baldes de lixo p/ cozinha em aço inox / aço lac. e plástico

Refª	Modulo em mm	Descrição	COR do corpo	
B100	300	Balde com correção extensível	Plástico Cinza	1

Refª	Modulo em mm	Descrição	COR do corpo	
B200	300	Balde com correção extensível e esquadros reguláveis	Plástico Cinza	1
Cor da tampa - Plástico Branco				

Baldes de lixo p/ cozinha em aço inox / aço lac. e plástico

Refª	Modulo em mm	Capacidade em litros	COR do corpo	COR da tampa	
B259	400	13	Aço Lac. Beje	Plástico Castanho	1
B259	400	13	Aço Lac. Branco	Plástico Branco	1
B398	300	10	Aço Inox	Plástico Castanho	6

Refª	Modulo em mm	Capacidade em litros	COR do corpo	COR da tampa	
B396	400	13	Aço Inox	Plástico Branco	1
B397	450	15	Aço Inox	Plástico Castanho	1

Baldes de lixo p/ cozinha em aço inox / aço lac. e plástico

Refª	Modulo em mm	Descrição	COR	
B270	400	Balde plástico Abertura da tampa sem fio	Branco Cinza	12

Refª	Modulo em mm	Descrição	COR	
B213	400	Balde plástico Abertura da tampa com fio	Beje Cinza	8

Perfil Rodapé alumínio e plástico p/ móveis de cozinha



Refª	Altura em mm			Preço MT	COR	
	100	120	150			
R815	✗	✗	✗		Cor de Alumínio	20 perfis
R825	✗	✗	✗		Revestido a Alumínio	20 perfis
R825	✗	✗	✗		Revestido a Inox	20 perfis
R830	✗		✗		Alumínio Mate	8 perfis
Comprimento do rodapé 4 MT						

Cantos para rodapé alumínio e plástico

Refª	Descrição	COR	
CAE90	Canto plástico Exterior 100 / 120 / 150 a 90°	Revestido a Alumínio / Inox Escovado	50
CAE135	Canto plástico Exterior 100 / 120 / 150 a 135°	Revestido a Alumínio / Inox Escovado	50

Refª	Descrição	COR	
C831	Canto alumínio Interior e Exterior 100 / 150 mm para todos os ângulos	Alumínio Mate	50
ELA	Elemento plástico de ligação 100 / 120 / 150	Revestido a Alumínio / Inox Escovado	50

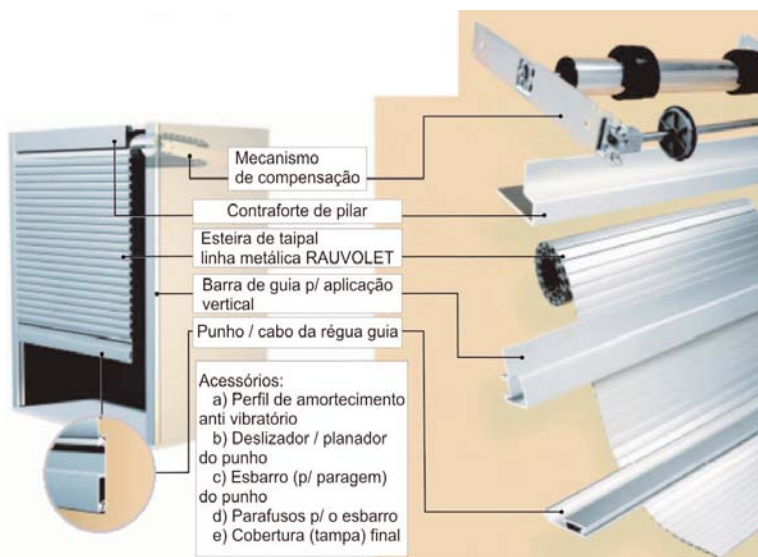
Persiana para móveis de cozinha



Ref ^a	Largura armário em mm	Altura armário em mm	Espessura painel em mm	
Z459	450	900	16	1
Z4146	450	1465	16	1
Z690	600	900	16	1

Ref ^a	Largura armário em mm	Altura armário em mm	Espessura painel em mm	
Z6146	600	1465	16	1
Z9146	900	1465	16	1

Terminais / Cantos e perfil lava louça



Ref ^a	ALUMÍNIO	PLÁSTICO	
	Cor	Cor	
260A	Alumínio natur.		20 perfis
386A	Granito		20 perfis
241P		Castanho claro	20 perfis
242P		Castanho rust.	20 perfis
263P		Branco	20 perfis

Ref ^a	ALUMÍNIO	PLÁSTICO	
	Cor	Cor	
C122I			100
C123E			100
T124			100
Comprimento do Perfil 5 MT			

Pés / Grampas e niveladores de móvel



Ref ^a	Medida em mm				COR	
	100	120	140	150		
P11	X	X	X		Preto	200
530 C/parafuso	X	X	X	X	Branco	250
530 S/parafuso	X	X	X	X	Branco	250
ALD	X	X	X		Preto	200
P100	X				Preto	400

Ref ^a	Medida em mm				COR	
	100	120	140	150		
G11				X	Preto	100
GRP				X	Preto	100
G530				X	Zincado	100
G531				X	Branco	100
G297				X	Preto	100
300				X	Branco/Castanho	100

Suportes de pano



Ref ^a	Medida em mm	COR	
112	430	Branco	10
113	430	Branco	10

Pés para móveis





Refª	Altura em mm	Descrição	
704	140 a 160	Pé com corpo em Alumínio e bases de Plástico Cinza	40
98D	100	Pé em Zamak Niquel Mate	10
703	130	Pé em Plástico Cinza	50
700	100	Pé em Zamak Br. Velho / Cromado Niquel Mate	10

Refª	Altura em mm	Descrição	
701	60/80/100	Pé em Inox Escovado	10
701	120	Pé em Inox Escovado	10
701	140	Pé em Inox Escovado	10
702	100	Pé em Zamak Niquel Escovado	10

Pés de mesa



Refª	Medida em mm	Descrição	
610	60 x 710	Pé de mesa Cromado	4
610	60 x 710	Pé de mesa Niq. Escovado	4
710	80 x 710	Pé de mesa Branco / Cinza	4
710	80 x 710	Pé de mesa Cromado	4

Refª	Medida em mm	Descrição	
710	80 x 710	Pé de mesa Niq. Escovado	4
870	80 x 870	Pé de mesa Cromado	4
870	80 x 870	Pé de mesa Niq. Escovado	4

Pernas de mesa e bancos

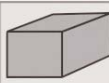

Refª	Descrição	COR	
PB	Perna de Banco	Castanho	2 pares
PM	Perna de Mesa	Castanho	1 par

Chapa em alumínio e tela para revestimento

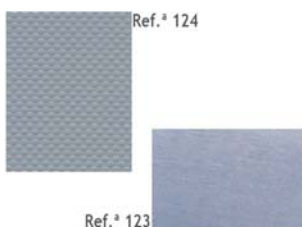



Refª	Descrição	Comp. x Largura	COR	
123	Chapa em alumínio p/ revestir móveis e cúpulas de exaustor	2 mt x 1mt	Alumínio	1

Refª	Descrição	Comp. x Largura	COR	
124	Tela em borracha p/ revestir fundos de gavetas e móveis	20 mt x 480 mm	Cinza	1

Fundos em alumínio p/ móveis de cozinha





Refª	Modulo em mm	Largura em mm	Comp. Em mm	
122-15	600	560	565	10
122-19	700	560	665	10
122-23	800	560	765	10

Refª	Modulo em mm	Largura em mm	Comp. Em mm	
122-27	900	560	865	10
122-31	1000	560	965	10
122-35	1200	560	1165	10

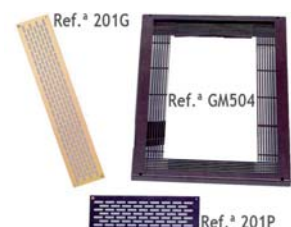
Grelhas em plástico e alumínio



Refª	Medida em mm	Descrição	COR	
201G	445x70	Grelha em alumínio p/ rodapé de cozinha	Branco Bronze Dourado Cr.Mate	10
201P	221x70	Grelha em alumínio p/ rodapé de cozinha	Dourado Cr.Mate	10
GM504	399x597	Grelha plástica para microondas	Dourado cor Alumínio	2

Refª	Medida em mm	Descrição	COR	
GM504	399x597	Grelha plástica para microondas	Branco/Preto Castanho	2
GM504	399x597	Grelha plástica para microondas	Niquel Satinado	5

Grelhas em plástico e alumínio



Refª	Medida em mm	Descrição	COR		Refª	Medida em mm	Descrição	COR	
R135	65x457	Respiro em plástico p/base de frigorífico	Branco Moca Carvalho	100	199	125x600	Grelha 8 elementos em alumínio p/forno	Branco Cr. Mate	25
R135	65x457	Respiro em plástico p/base de frigorífico	Prateado	100	199	125x600	Grelha 8 elementos em alumínio p/forno	Bronze Dourado	20
199	125x600	Grelha 8 elementos em plástico p/forno	Branco Castanho	20	199	125x600	Grelha 8 elementos em alumínio p/forno	Cor Inox	25

Corrediças com rolete em nylon



Refª	Altura em mm	Comprimento em mm				COR		Refª	Altura em mm	Comprimento em mm				COR	
		250	300	350	400					450	500	550	600		
C800		X	X	X	X	Branco e Castanho		C800		X	X	X	X	Branco e Castanho	
Lg801	85		X	X	X		25	Lg801	85	X	X	X	X		10
Lg801	120		X	X	X		10	Lg801	120	X	X	X	X		10
Lg801	150		X	X	X		10	Lg801	150	X	X	X	X		10

Corrediças de esferas



Refª	Comprimento em mm					COR		Refª	Comprimento em mm					COR	
	182	214	246	278	310				342	374	406	438	502		
E17	X	X	X	X	X	Zincado	100	E17	X	X	X	X	X	Zincado	50
E27		X	X	X	X	Zincado e Amarelo	50	E27	X	X	X			Zincado e Amarelo	50
								E27				X	X	Zincado e Amarelo	40

Corrediças de esferas extracção total

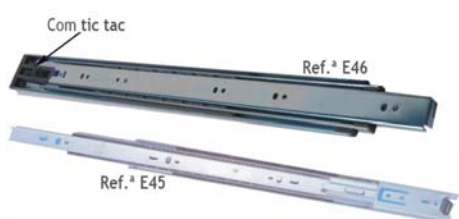

Refª	Comprimento em mm					COR		Refª	Comprimento em mm					COR	
	250	300	350	400	450				500	550	600	650	700		
E45	X	X	X	X	X	Zincado	15	E45	X	X	X	X	X	Zincado	15
E46			X	X	X	Zincado	15	E46	X	X	X	X	X	Zincado	15

Corrediças ocultas



Refª	Comprimento em mm				COR		Refª	Comprimento em mm		COR	
	250	300	350	400				450	500		
O87	X	X	X	X	Zincado		O87	X	X	Zincado	
O88	X	X	X	X		20	O88	X	X		20
O89	X	X	X	X		20	O89	X	X		20

Apanha fumos e perfil vedante de rodapé

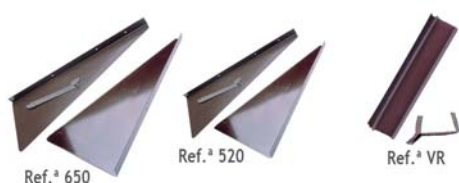

Refª	Medida em mm	COR	
520	520	Branco / Castanho	10
650	650	Branco / Castanho	10
VR	16 x 3600	Branco / Pinho mel Transparente / Castanho	20 Perfis

Suportes e tubo Ø28 mm p/ cortinados

Refª	Cores Disponíveis		Imagem
	Branco	Castanho	
T280	X	X	6 Tubos
2203	X	X	100
2204E	X	X	20

Refª	Cores Disponíveis		Imagem
	Branco	Castanho	
2205	X	X	20
COMPRIMENTO DO TUBO 4 / 5 MT			

Argolas / Ganchos e terminais p/ tubo Ø28 mm p/ cortinados

Refª	Cores Disponíveis		Imagem
	Branco	Castanho	
2206	X	X	20
2207G	X	X	100
2207P	X	X	100

Refª	Cores Disponíveis		Imagem
	Branco	Castanho	
2208G	X	X	1000
2208P	X	X	1000
2209	X	X	1000

Suportes / Tubo Ø e Tubo oval p/ roupeiro

Refª	Cores Disponíveis			Imagem
	Branco	Castanho	Cromado	
T160	X	X		10 Tubos
20x15	X	X		20 Tubos
16x30			X	10 Tubos

Refª	Cores Disponíveis			Imagem
	Branco	Castanho	Cromado	
S603	X	X		500
S604	X	X		200
COMPRIMENTO DO TUBO 4 / 5 MT				

Suportes topo e central p/ tubo de roupeiro

Refª	Acabamento				Imagem
	L. Branco	L. Castanho	Z. Amarelo	Niquelado	
S112	X	X	X	X	200
S600			X	X	200
S601			X		100

Refª	Acabamento				Imagem
	L. Branco	L. Castanho	Z. Amarelo	Niquelado	
S602	X	X	X	X	100
S606	X	X	X		100
S607	X	X	X	X	100

Espuma / Cola / Cera

Refª	Cores Disponíveis	Imagem
CERA	Branco / Carvalho / Castanho Emberô / Faia / Mogno / Pinho Natural / Nogueira / Preto / Teka Caoba / Cerejeira	20

Refª	Descrição	Imagem
COLA CIMALHA	Cola rápida para montagem de cimalthas	12
1 C-PU	Espuma de isolamento e montagem	12

Colas brancas e Colas de contacto

Refª	Descrição	Embalagem			
		1 Kg	5 Kg	20 Kg	70 Kg
Express T0 50	Cola muito rápida indicada para a montagem de móveis, trabalhos de carpintaria e marcenaria. Apresenta uma resistência inicial das colagens elevada e tempos de prensagem curtos.	X	X	X	X

Refª	Descrição	Embalagem		
		1 Lt.	5 Lt.	20 Lt.
Rakolite B	Cola de contacto universal indicada para revestimento de painéis do tipo aglomerados de madeira, plátex, MDF, contraplacados, etc. Com laminado. Cola económica.	X	X	X

Roletos c/ argola / Gancho e Pinça p/ calha de sanefa



Refª	Acabamento			
	Lacado Branco	Zincado	Nylon	
2159	X	X	X	500
2161	X	X	X	100
2163	X	X	X	100

Refª	Acabamento			
	Lacado Branco	Zincado	Nylon	
2166	X	X		100
2188	X	X		100
2189	X	X		100

Cruzamentos c/ argola / Ganchos e pinça p/ calha de sanefa



Refª	Acabamento		
	Lacado Branco	Zincado	
2183	X	X	100
2185	X	X	100

Terminais / Uniões / Suportes e Calha de sanefa



Refª	Acabamento			
	Lacado Branco	Zincado	Nylon	
C2000	X	X		20 Calhas
2118	X	X		100
2149	X	X		50
2150	X	X		50

Refª	Acabamento			
	Lacado Branco	Zincado	Nylon	
2152	X	X		50
2167	X	X	X	100

COMPRIMENTO DA CALHA 4 / 5 MT

Esquadros e suportes p/ armários e sanefas



Refª	Acabamento		
	Zincado	Amarelo	
1		X	500
2		X	100
3		X	100
4		X	100
5		X	100

Refª	Acabamento		
	Zincado	Amarelo	
6	X	X	100
7	X	X	100
18-B	X	X	150
E19		X	150

Compassos



Refª	Descrição	COR		
		Cinza	Branco	
CT	Compasso tação	Cinza	Branco	10
C25CE	Compasso calha de elevação	Niquel.		10
C30PB	Compasso porta de bar	Z. Amara.		100

Refª	Descrição	COR		
		Z. Amara.	Branco Castanho	
C31PL	Compasso papelreira	Z. Amara.		100
C32CV	Compasso de cavalete	Z. Amara.		100
C111	Compasso de afinação	Branco Castanho		10

Amortecedor e compassos de elevação p/ portas



Refª	Descrição	COR		
		Cinza	Niquel.	
67B	Compasso elevação a gás	Cinza		12
098	Compasso elevação articulado	Niquel.		6
099	Compasso elevação p/portas microondas	Cinza		10

Refª	Descrição	COR		
		Branco Castanho	Cinza	
A68	Amortecedor para portas	Branco Castanho	Cinza	100
097	Compasso elevação articulado	Niquel.		6

Corrediças de mesa com cabo de aço



Refª	Descrição	Comprimento em mm				20
		450	600	650	700	
CMO807	Corrediça c/ cabo de aço para mesa oval		X	X	X	20
CME805	Corrediça para mesa elástica	X				20

Refª	Descrição	710	750	800	900	20
CMO807	Corrediça c/ cabo de aço para mesa oval		X	X	X	20

Refª	Descrição	1000	1100	1300	20
CMO807	Corrediça c/ cabo de aço para mesa oval	X	X	X	20

Corrediças de mesa sem cabo de aço



Refª	Descrição	Comprimento em mm				25
		600	650	700	750	
CMO803	Corrediça s/ cabo de aço para mesa oval	X	X	X	X	25

Refª	Descrição	800	25
CMO803	Corrediça s/ cabo de aço para mesa oval	X	25

Corrediças frente de cair duplas e simples p/ TV/Video



Refª	Comprimento em mm				COR	20
	300	350	400	450		
CV809	X	X	X	X	Castanho	20
CV808		X	X			30

Refª	500	COR	20
CV809	X	Castanho	20

Corrediças de bolso p/ portas de TV



Refª	Comprimento em mm				COR	15
	350	400	450	500		
CB804	X	X	X	X	Z.Amarelo	15

Refª	550	COR	15
CB804	X	Z.Amarelo	15

Lateral XP com amortecedor p/ gaveta



Refª	Descrição	COR	20
XP	Lateral XP Gaveta 500	Prateada	20

Lateral XP com amortecedor p/ gavetão

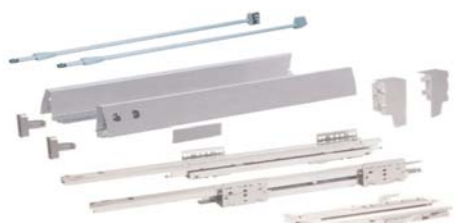

Refª	Descrição	COR	20
XP	Lateral XP Gavetão 500	Prateada	20

Lateral 4HOME c/ amortecedor p/ gaveta



Ref ^ª	Descrição	COR	
4H201	Lateral p/Gaveta 400	Prateada	6
4H201	Lateral p/Gaveta 500	Prateada	6

Lateral 4HOME c/ amortecedor p/ gavetão



Kit de acessórios para fazer gavetão 4H202 c/ 200 mm de altura



Ref ^ª	Descrição	COR	
4H202	Lateral p/Gavetão 400	Prateada	6
4H202	Lateral p/Gavetão 500	Prateada	6

Porta talheres inox



Ref.ª 9032



Mod. 900/1000
1 Kits ref.ª 9032
1 Kits ref.ª 9042

Ref.ª 9042

Mod. 800
2 Kits ref.ª 9032

Ref ^ª	Descrição	Modulo	COR	
9032	Kit porta talheres 65 X 280 X 475 MM	400/450/500	INOX	1
9042	Kit porta talheres 65 X 380 X 475 MM	550/600	INOX	1

Perfil em alumínio p/ portas de vidro e esquadro

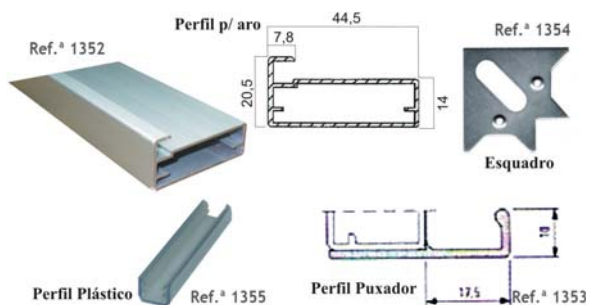

Ref ^ª	Acabamento	
1352	Cromado Mate	10
1352	Cor Inox Escov.	10
1353	Cromado Mate	10
1354	Ferro Zincado	100
Comprimento das Barras 5 MT		

Ref ^ª	Acabamento	
1355	Plástico Transparente	20
Comprimento das Barras 4 MT		

Perfil em alumínio orlar portas de madeira

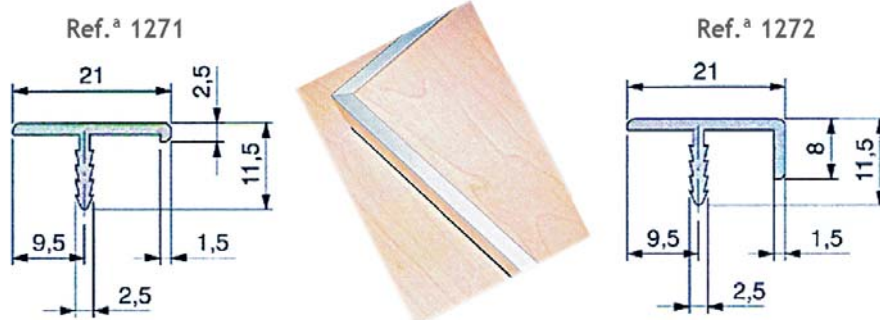

Refª	Acabamento	
1271	Cromado Mate	10
1272	Cromado Mate	10
Comprimento das Barras 5 MT		

Perfil de puxador em alumínio para portas de madeira

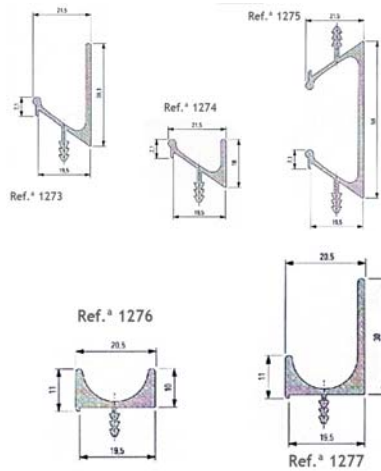

Refª	Acabamento	
1273	Cromado Mate	10
1274	Cromado Mate	10
1275	Cromado Mate	10
Comprimento das Barras 5 MT		

Refª	Comprimento total em mm						
	297	347	397	447	497	547	597
1276	X	X	X	X	X	X	X
1277	X	X	X	X	X	X	X
Refª	Comprimento total em mm						
	697	797	897	997	1097	1197	
1276	X	X	X	X	X	X	
1277	X	X	X	X	X	X	
Acabamento	Cromado Mate						 10

Sistemas de portas de correr



Bases de TV

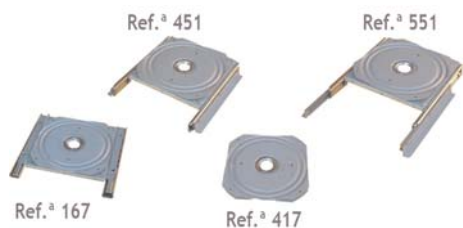

Refª	Descrição	COR	
167	Base de tv rotativa 1 lance ao baixo	Zincado	10
417	Base de tv rotativa fixa 260 x 260	Zincado	10

Refª	Descrição	COR	
451	Base de tv rotativa 1 lance ao alto	Zincado	10
551	Base de tv rotativa 2 lances ao alto	Zincado	10

Perfil para portas de roupeiro

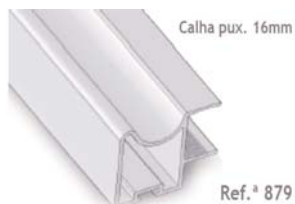

Comprimento das Barras	Acabamento	
5 MT	Lacado Branco	10
5 MT	Cr. Mate	10
5 MT	Bronze/Dourado/Cor Inox	10
5 MT	Cor Inox Escovado	10

Comprimento das Barras	Acabamento	
5 MT	Mogno/Pinho/Faia Branca	10
5 MT	Carvalho/Faia Vap./Kamb.	10
5 MT	Cerej. Usa-bras./Tola/Izombé Sucupira	10
5 MT	Melamina: Carvalho/Tola Faia/Mogno/Izombé	10

Perfil para portas de roupeiro

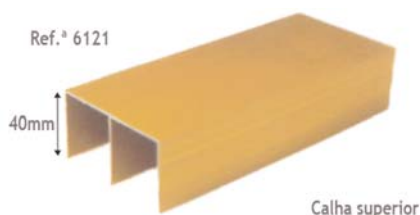

Comprimento das Barras	Acabamento	
5 MT	Lacado Branco	8
5 MT	Cr. Mate	8
5 MT	Bronze/Dourado/Cor Inox	8
5 MT	Cor Inox Escovado	8

Comprimento das Barras	Acabamento	
5 MT	Mogno/Pinho/Faia Branca	8
5 MT	Carvalho/Faia Vap./Kamb.	8
5 MT	Cerej. Usa-bras./Tola/Izombé Sucupira	8
5 MT	Melamina: Carvalho/Tola Faia/Mogno/Izombé	8

Perfil para portas de roupeiro



Comprimento das Barras	Acabamento	
5 MT	Lacado Branco/Cr. Mate	8
5 MT	Bronze/Dourado/Cor Inox	8
5 MT	Cor Inox Escovado	8

Perfil para portas de roupeiro



Comprimento das Barras	Acabamento	
5 MT	Lacado Branco/Cr. Mate	10
5 MT	Bronze/Dourado/Cor Inox	10
5 MT	Cor Inox Escovado	10
5 MT	Mogno/Pinho/Faia Branca	10

Comprimento das Barras	Acabamento	
5 MT	Carvalho/Faia Vap./Kamb.	10
5 MT	Cerej. Usa-bras./Tola/Izombé Sucupira	10
5 MT	Melamina: Carvalho/Tola Faia/Mogno/Izombé	10

Perfis de alumínio “faça você mesmo”

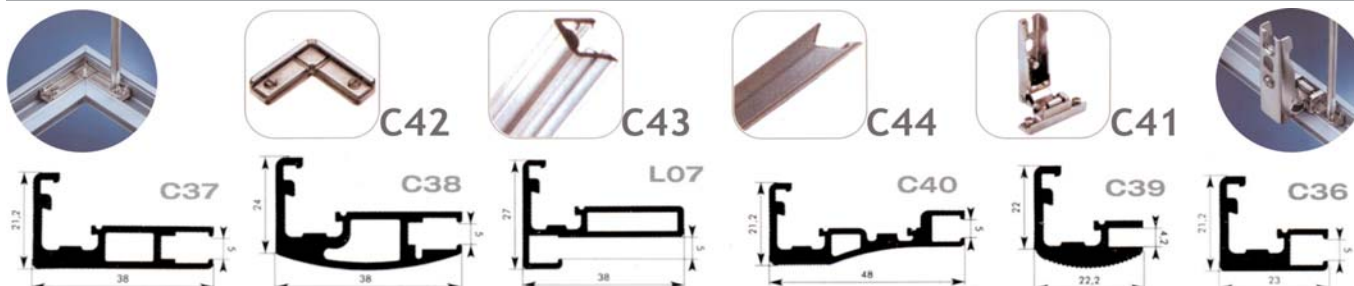

Perfil SF-25 para portas de correr até 25 kg de peso

					
Ref.ª 25P		Ref.ª 25J			
Descrição	Perfil Alum. Natural	Perfil Alum. Dourado	Jogo completo de Acessórios		
	X	X	X		
Med.perfil	3 e 5 MT				
	25 Perfis		25 Jogos		

Perfil SF-51 para portas de correr até 51 kg de peso

					
Ref.ª 51P		Ref.ª 52P		Ref.ª 51J	
Descrição	Perfil Alum. Natural	Perfil Alum. Dourado	Jogo completo de Acessórios		
Ref.ª 51 P	X	X	X		
Ref.ª 52 P	X	X	X		
Med.perfil	3 e 5 MT				
	25 Perfis		10 Jogos		

Perfil para portas de correr até 30 kg de peso

							
Ref.ª 6661		Ref.ª 6662		Ref.ª 6663		Ref.ª 6664	
Descrição	Perfil Superior Alumínio Mate	Perfil Inferior Alumínio Mate	Jogo completo de Acessórios		Jogo completo de Acessórios		
Med.Perfil	2 e 3 MT	2 e 3 MT					
	50 Perfis	50 Perfis	25 Jogos		25 Jogos		

Perfil SF-22 para portas de correr 22/24 kg de peso

 Ref.ª 22P  12X6,5 mm		 Ref.ª 22J		 Ref.ª 24J	
Descrição	Perfil Plástico Castanho	Perfil Alumínio Natural	Jogo completo de Acessórios		
Med.perfil	3 MT	3 e 5 MT	* Roletos inferiores com rolamentos		
	25 Perfis		25 Jogos		

Perfil SF-30 para portas de correr até 30 kg de peso

 Ref.ª 30D  54x27 mm	 Ref.ª 30S  20x26 mm	 Ref.ª 30J	 Ref.ª 30G	 Ref.ª 30T	
Descrição	Perfil Superior Duplo Alumínio	Perfil Superior Simples Alumínio	Jogo completo de Acessórios	Guia Inferior	Batente Travão
Med.perfil	2 / 3 / 5 MT	2 / 3 / 5 MT			
	10 Perfis	10 Perfis	10 Jogos	25 Unidades	25 Unidades

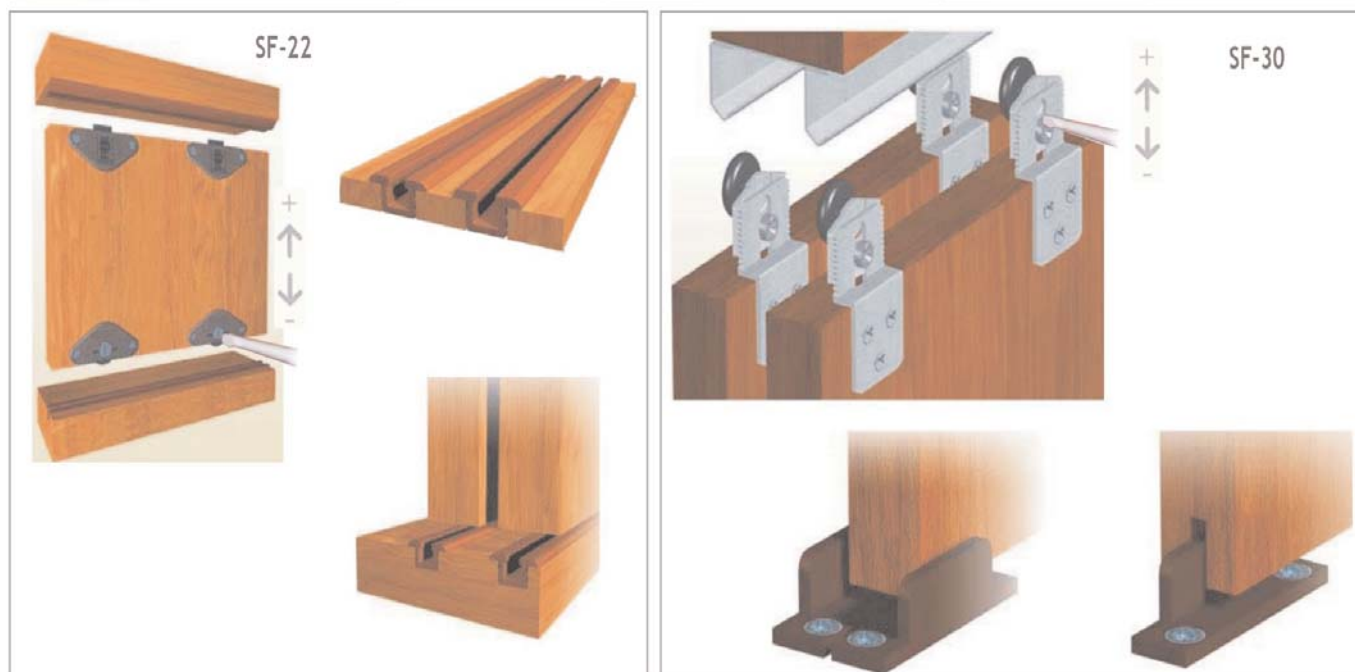







Perfil SF-E40 para portas de correr até 40 kg de peso

Novo

 Ref.ª 39P  27,5x26,5mm	 Ref.ª 39J	 Ref.ª 61G	 Ref.ª 39T	 Ref.ª 61SP	 Ref.ª 61ST	
Descrição	Perfil Superior Alumínio	Jogo completo de Acessórios	Guia Inferior	Travão Retentor	Suporte Parede	Suporte Tapeta
Med.perfil	2 / 3 / 5 MT					
	6 Perfis	10 Jogos	25 Unidades	25 Unidades	25 Unidades	10 Unidades

Perfil SF-A61 e SV-A60 p/ portas de correr até 60 kg de peso

Novo

 Ref.ª 61P  30x29mm	 Ref.ª 61J	 Ref.ª 61G	 Ref.ª 61T	 Ref.ª 66J	
Descrição	Perfil Superior Alumínio	Jogo completo de Acessórios	Guia Inferior	Travão Retentor	Jogo completo de Acessórios p/ PORTAS DE VIDRO
Med.perfil	2 / 3 / 5 MT				
	10 Perfis	10 Jogos	25 Unidades	25 Unidades	1 Jogo

Perfil SF-A125 para portas de correr até 125 kg de peso

 Ref.ª 125P  38,5x40,5 mm	 Ref.ª 41P  22,5x22 mm	 Ref.ª 125J	 Ref.ª 41G	 Ref.ª 125 SP	 Ref.ª 61 ST	
Descrição	Perfil Superior Alumínio	Perfil Inferior Alumínio	Jogo completo de Acessórios	Guia Inferior	Suporte Parede	Suporte Tapeta
Med.perfil	2 / 3 / 5 MT	3 / 5 MT				
	10 Perfis	10 Perfis	1 Jogo	25 Unidades	25 Unidades	10 Unidades

Perfil SF-A62D / SF-A63D e SF-A64D até 35 kg de peso por porta

 Ref.ª 61P  30x29 mm	 Ref.ª 41P  22,5x22 mm	 Ref.ª 62J	 Ref.ª 63J	 Ref.ª 64J	
Descrição	Perfil Superior Alumínio	Perfil Inferior Alumínio	Jogo completo de Acessórios	Jogo completo de Acessórios	Jogo completo de Acessórios
Med.perfil	2 / 3 / 5 MT	3 / 5 MT			
	10 Perfis	10 Perfis	5 Jogos	5 Jogos	5 Jogos

SF-30D até 30 kg de peso por par

 Ref.ª 3150  22x22,5 mm	 Ref.ª 16P  18x13 mm	 Ref.ª 3100	
Descrição	Perfil Superior Alumínio	Perfil Inferior Alumínio	Jogo completo de Acessórios
Med.perfil	2 / 3 / 5 MT	2 / 3 / 5 MT	
	2 Perfis	2 Perfis	1 Jogo

SF-60D e SF-L60D até 60 kg de peso por par

 Ref.ª 65P  31x31 mm	 Ref.ª 6507	 Ref.ª 6505	
Descrição	Perfil Superior Alumínio	Jogo completo de Acessórios	Jogo completo de Acessórios
Med.perfil	2 / 3 / 5 MT		
	2 Perfis	1 Jogo	2 Jogos

Varão oval em alumínio p/ roupeiros e suportes



Refª	Medida em mm	Acabamento	
1141	15 x 27	Cromado Mate	20
1141	15 x 27	Dourado	20
3002	16 x 30	Cromado Mate	20
Comprimento do varão 5 MT			

Refª	Medida em mm	Acabamento	
3002	16 x 30	Dourado	20
3002	16 x 30	Bronze	20
6101	Ø 16	Cromado Mate	10
Comprimento do varão 5 MT			

Varão oval em alumínio p/ roupeiros e suportes

Refª	Acabamento		Refª	Acabamento		Refª	Acabamento	
ST3002	Niquelado	100	ST3002	Cromado Mate	100	ST1141	Lacado Mate	100
SC3002	Dourado	100	SC3002	Bronze	100	SC1141		100

Cabides extensíveis p/ roupeiros



Descrição	Acabamento
Cabide Extensível duplo 10 Kg - 450 mm A 600 mm - 600 mm A 830 mm - 830 mm A 1150 mm	Lac. Preto com Cromado
	1

Cabides extensíveis p/ roupeiros



Descrição	Acabamento
Cabide Extensível duplo Com variador / 20 Kg. Min. 750 mm Max. 1170 mm	Lac. Preto com Cromado
	1

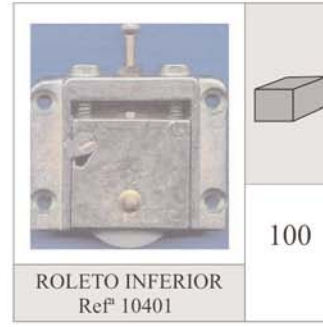
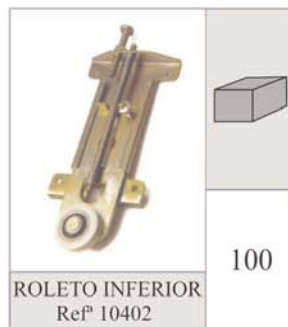
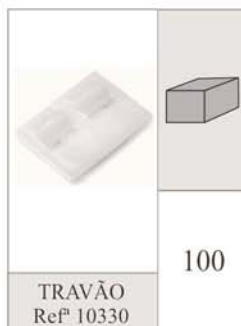
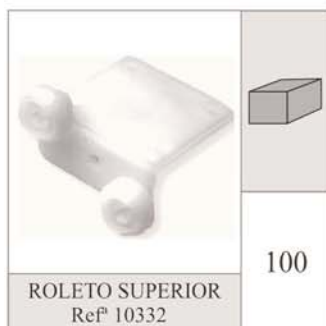
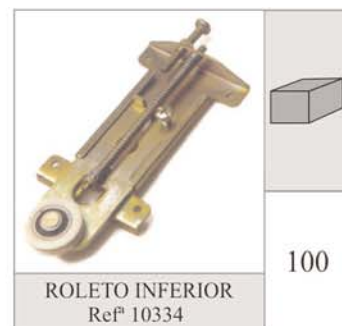

Roletos para portas de roupeiro

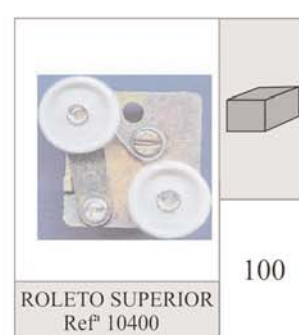

	Descrição	
	Feltro de vedação em rolos de 225 MT	
	COR	
Refª 10338F	Cinza	4 rolos



Rodas giratórias com e sem travão



Refª	Medidas em mm			COR	
	∅	H	CxB		
R50	50	63	42x42	Zinc. / Cinza	50
R50	75	98	60x60	Zinc. / Cinza	20
R51	50	63	42x42	Zinc. / Cinza	50
R51	75	98	60x60	Zinc. / Cinza	20
R52	50	63	42x42	Zinc. / Transp.	50
R52	75	98	60x60	Zinc. / Transp.	20
R53	50	63	42x42	Zinc. / Transp.	50
R53	75	98	60x60	Zinc. / Transp.	20

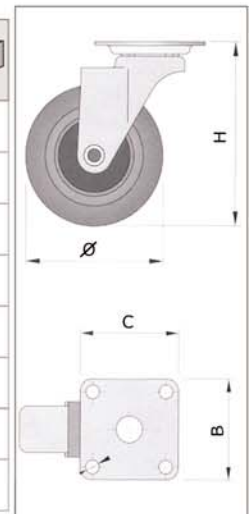

Refª	Medidas em mm			COR	
	∅	H	CxB		
R27	50	73	42x42	Cinza	100
R27	60	84	42x42	Cinza	100
R61	50	73	42x42	Cinza	100
R61	60	84	42x42	Cinza	100
R54	64	100	M10	Alumínio/Faixa Alum./Cerejeira	50
R54	75	120	M10	Alumínio/Alum.	50
R55	64	100	64x45	Alumínio/Faixa Alum./Cerejeira	50
R55	75	120	64x45	Alumínio/Alum.	50
R56	75	120	64x45		50
* As rodas R27 e R61 podem ser fornecidas c/tampas em madeira.			∅ 50	Cerejeira	100
			∅ 60	Faixa	100

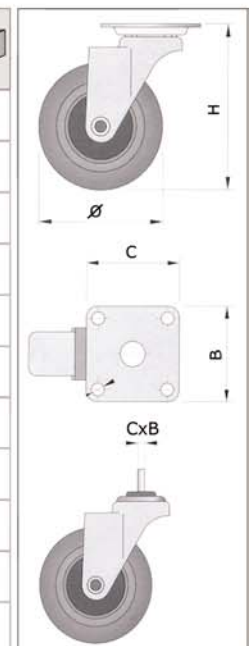

Refª	Medidas em mm			COR	
	∅	H	CxB		
R57	30	40	12	Preto	200
R58	50	65	42x42	Alumínio/Faixa Alum./Cerejeira	100
R59	50	65	42x42		50
R59	75	100	60x60	Mate /Faixa Mate/Cerejeira	50
R60	50	65	42x42		50
R60	75	100	60x60		50
R749	30	33	48x21	Zinc. Branco	100

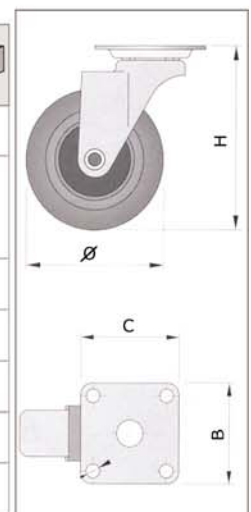

Focos c/ lâmpada de halogénio

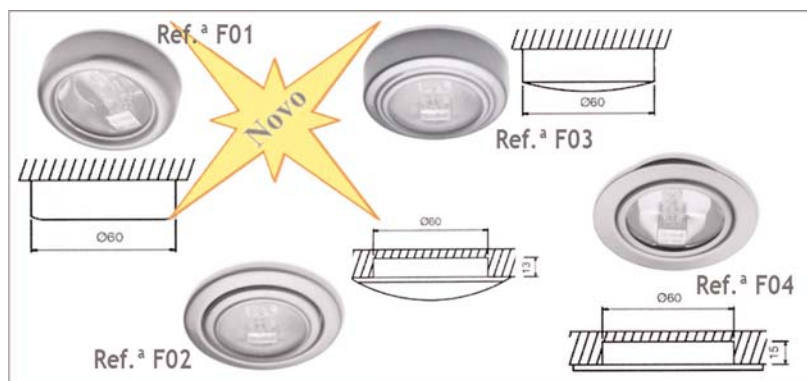

Refª	Potência	Acabamento	
F01	20 W	Niq. Satinado	20
F02	20 W	Niq. Satinado	20
F03	20 W	Niq. Satinado	20
F04	20 W	Niq. Satinado	20

Focos c/ lâmpada fluorescente

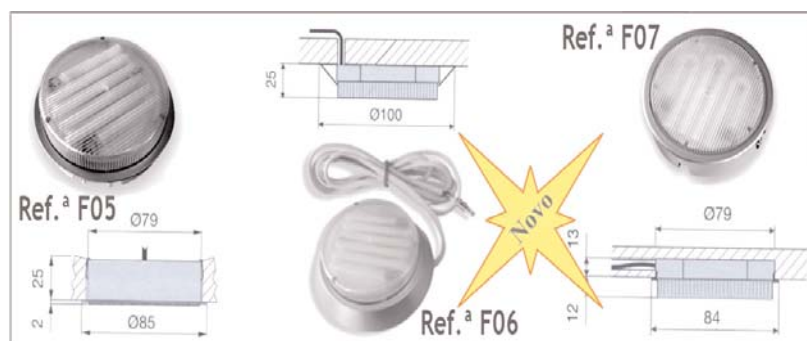

Refª	Potência	Acabamento	
F05	7 W	Cor Alumínio	20
F06	7 W	Cor Alumínio	20
F07	7 W	Cor Alumínio	20

Focos c/ lâmpada Ledis

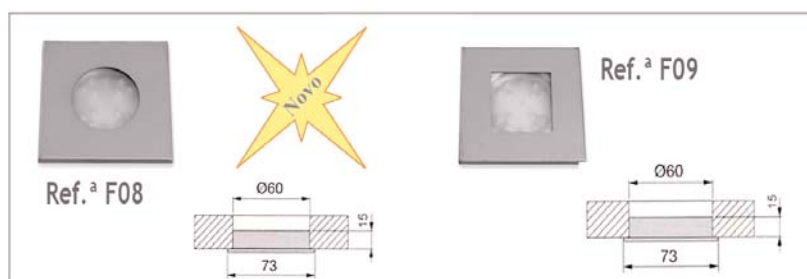

Refª	Potência	Acabamento	
F08	0,72 W	Alumínio mate	20
F09	0,72 W	Alumínio mate	20

Transformadores eléctricos



Refª	Potência	Medidas	
F10	6 W	102x51x30	20
F11	60 W	91x41x19	20
F12	60 W	149x42x19	20

Interruptores e suporte



Refª	Descrição	Acabamento	
F13	Suporte p/ focos de Halogéneo	Níquel Satinado	10
F14	Interruptor de embutir Ø23x17	Branco ou Preto	100
F15	Interruptor para porta	Branco ou Preto	10

Respiros planos quadrados em chapa

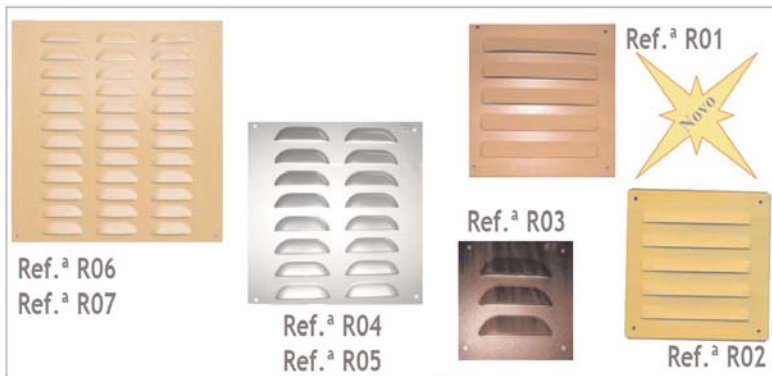

Refª	Medida mm	Acabamento		
		Branco Castanho Faia	Inox	
R01	150x150	X	X	50
R02	150x150	X	X	50
R03	100x100	X		50
R04	150x150	X	X	50
R05	200x200	X	X	50
R06	250x250	X	X	50
R07	300x300	X	X	50

Respiros planos rectangulares e redondos em chapa

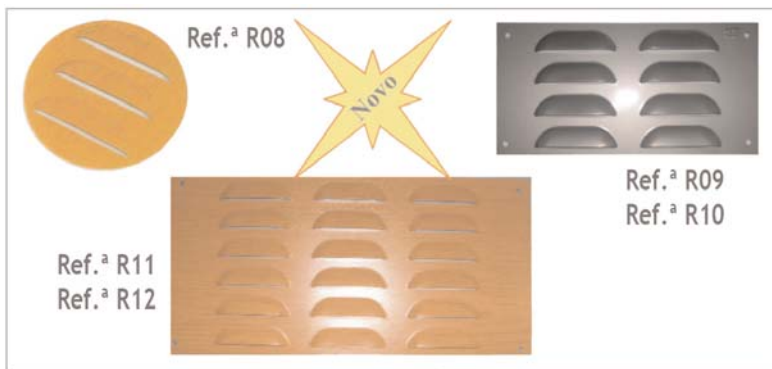

Refª	Medida mm	Acabamento		
		Branco Castanho Faia	Inox	
R08	∅ 90	X		50
R09	150x100	X		50
R10	200x100	X		50
R11	250x150	X		50
R12	300x150	X		50

Respiros em plástico



Refª	Medida mm	COR		
		Branco Bege Castanho		
R15	120x120	X		60
R16	150x150	X		60
R17	200x200	X		50
R18	250x250	X		30
R19	300x300	X		35
R20	400x400	X		15
R21	300x150	X		70
R22	400x200	X		30
R23	250x100	X		20
R24	170x60	X		80
R25	150x150	X		50
R26	∅ 120	X		18
R27	∅ 140	X		40

Caixa de correio plástica

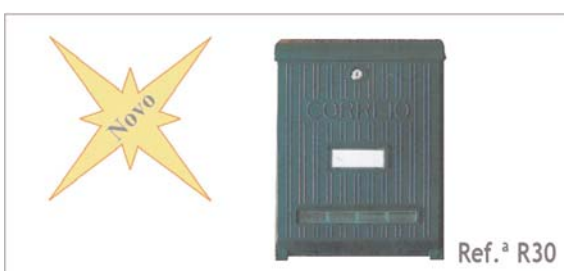

Refª	Características	COR	
R30	Peso: 2.200 grs. Boca: 25,5 x 3,5 cm Altura: 42 cm Fundo: 12 cm Largura: 30,5 cm	Branco Cinza Verde	1

Puxador c/ Controlo de acesso



k 200 / k 75

DuoSystem 200 / 75 *
DuoSystem k 200 / k 75 *

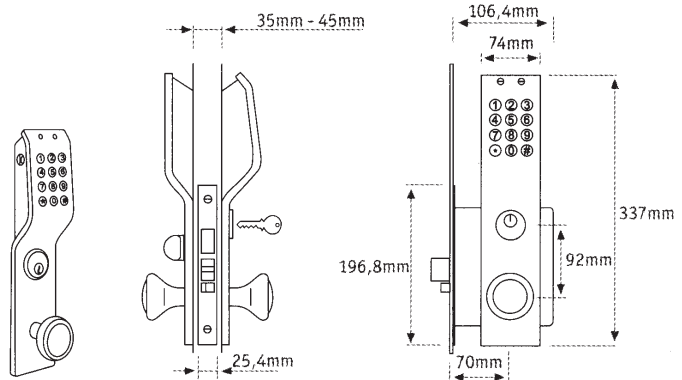

Puxador c/ Controlo de acesso



iTronic

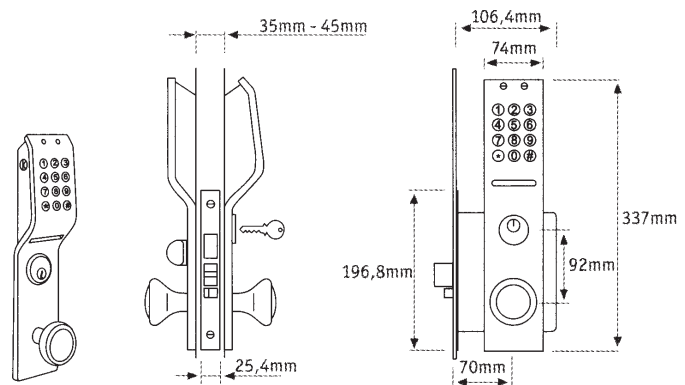

Controlo de acesso



k 200 / k 75

ContagAccess 200 / 75
ContagAccess k 200 / k 75

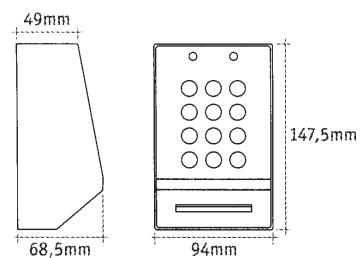
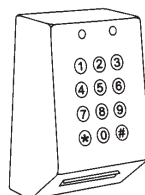

Puxadores c/ fechadura de roseta

 techno TH
drop A

drop A (Roseta)

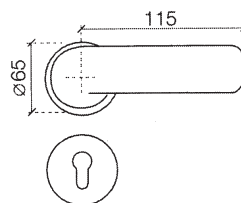

passagem / passage - ref.: 2772CLH(d/e)xxx



CG68 - ref.: 2775CLH(d/e)xxx



CP85 - ref.: 2776CLH(d/e)xxx



WC - ref.: 2651000-xxx

Puxadores c/ fechadura de espelho

 techno TH
drop A

drop A (Espelho)

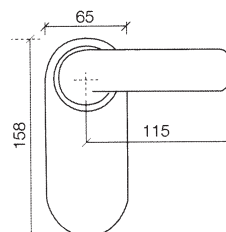

passagem / passage - ref.: 2752CLH(d/e)xxx



CG68 - ref.: 2755CLH(d/e)xxx



CP85 - ref.: 2756CLH(d/e)xxx



WC - ref.: 2651000-xxx

Puxadores c/ fechadura de roseta

 techno TH
drop AS

drop AS (Roseta)

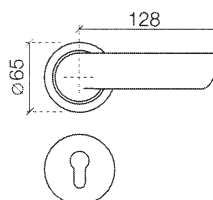

passagem / passage - ref.: 2772CMH(d/e)xxx



CG68 - ref.: 2775CMH(d/e)xxx



CP85 - ref.: 2776CMH(d/e)xxx



WC - ref.: 2651000-xxx

Puxadores c/ fechadura de espelho

 techno TH
drop AS

drop AS (Espelho)

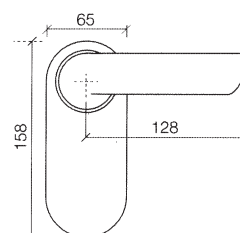

passagem / passage - ref.: 2752CMH(d/e)xxx



CG68 - ref.: 2755CMH(d/e)xxx



CP85 - ref.: 2756CMH(d/e)xxx



WC - ref.: 2651000-xxx

Puxadores c/ fechadura de roseta



techno TH
ergo A



ergo A (Roseta)

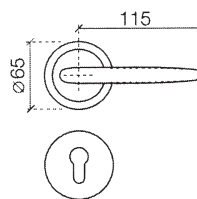

passagem / passage - ref.: 2772CFH(d/e)xxx



CG68 - ref.: 2775CFH(d/e)xxx



CP85 - ref.: 2776CFH(d/e)xxx



WC - ref.: 2651000-xxx

Puxadores c/ fechadura de espelho



techno TH
ergo A

ergo A (Espelho)

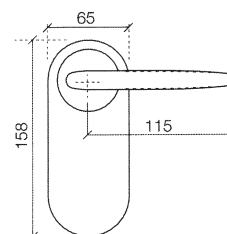

passagem / passage - ref.: 2752CFH(d/e)xxx



CG68 - ref.: 2755CFH(d/e)xxx



CP85 - ref.: 2756CFH(d/e)xxx



WC - ref.: 2651000-xxx

Puxadores c/ fechadura de roseta



techno TH
ergo B



ergo B (Roseta)

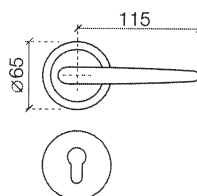

passagem / passage - ref.: 2772CHH(d/e)xxx



CG68 - ref.: 2775CHH(d/e)xxx



CP85 - ref.: 2776CHH(d/e)xxx



WC - ref.: 2651000-xxx

Puxadores c/ fechadura de espelho



techno TH
ergo B

ergo B (Espelho)

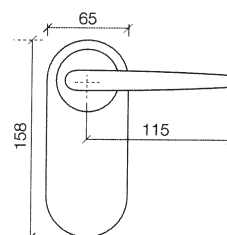

passagem / passage - ref.: 2752CHH(d/e)xxx



CG68 - ref.: 2755CHH(d/e)xxx



CP85 - ref.: 2756CHH(d/e)xxx



WC - ref.: 2651000-xxx

Puxadores c/ fechadura de roseta

 techno TH
bionic B

bionic B (Espelho)

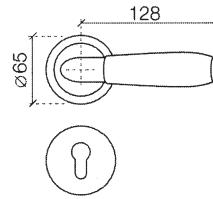

passagem / passage - ref.: 2772CJH(d/e)xxx



CG68 - ref.: 2775CJH(d/e)xxx



CP85 - ref.: 2776CJH(d/e)xxx



WC - ref.: 2651000-xxx

Puxadores c/ fechadura de espelho

 techno TH
bionic B

bionic B (Espelho)

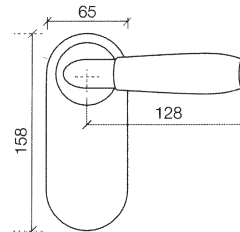

passagem / passage - ref.: 2752CJH(d/e)xxx



CG68 - ref.: 2755CJH(d/e)xxx



CP85 - ref.: 2756CJH(d/e)xxx



WC - ref.: 2651000-xxx

Puxadores

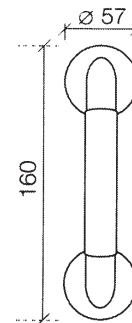

techno

 Asa de porta bionic
ref.: 2632001-xxx
Par de asas de porta bionic
ref.: 2637001-xxx

 Asa de porta ergo/drop
ref.: 2632002-xxx
Par de asas de porta ergo/drop
ref.: 2637002-xxx

Puxadores c/ fechadura de roseta

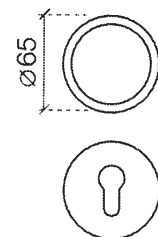

techno



puxador de porta de entrada TH / entrance door knob TH

ref.: 2622004-xxx

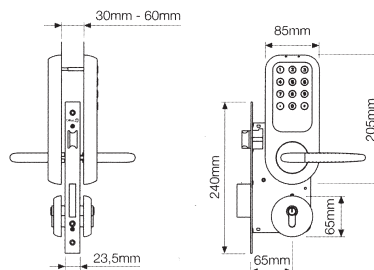
Puxador c/ Controlo de acesso



ref.: DS100
puxador / knob
acabamento / finish
espessura de porta / door thickness
abertura / handing

Puxador c/ Controlo de acesso

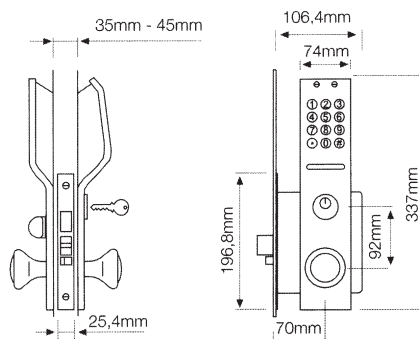

ref.: DuoSystem 200 / DuoSystem 75
ou/ou DuoSystem K200 / DuoSystem K75

puxador / knob
acabamento / finish
espessura de porta / door thickness
abertura / handing

Todos os modelos / All models:
teclado resistente a vandalismo
/ vandal resistant keyboard
mais de 1 milhão de códigos possíveis
/ more than a million possible codes
abertura por comando remoto
/ external remote opening

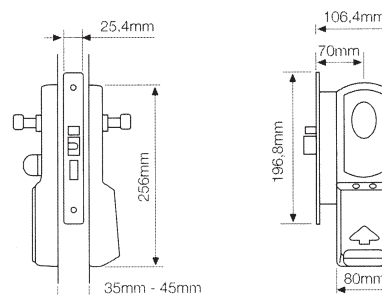

Puxador c/ Controlo de acesso

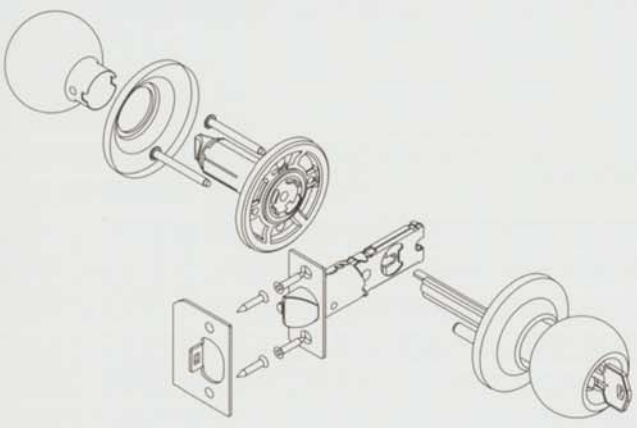

ref.: 2F05020-xxx (direita / right)
ref.: 2F05021-xxx (esquerda / left)

Puxadores c/ fechadura

Funções	Modelos			
	MODELO	A	B	C
	2900 Bola	65	64	53
	2600 Shelton	65	61	50
	2800 Nobel	65	56	55
	2800 Madera	65	68	54
	2500 Tulipa	65	58	53
	2400 Beta	65	61	50

	00	ENTRADA: ambos lados son condenados y descondenados por la llave exterior o la muletilla interior.
	03	BAÑOS Y DORMITORIOS: ambos lados son condenados y descondenados por la muletilla interior. Posibilidad de descondena exterior mediante dispositivo de emergencia.
	05	PUERTAS DE PASO: ambos lados siempre libres.

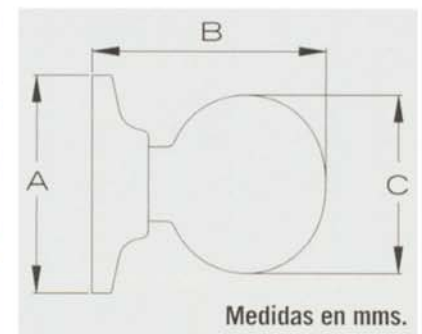

Modelos

2900 - Bola Acabados: LP, LM, LA, CM, CR, NS, MB, BL, BP, NE, NP, ML, MCL		2800 - Madera Acabados: ML, MCL	
2600 - Shelton Acabados: LP, LM, CM, CR		2500 - Tulipa Acabados: LP, LM, LA, CR, CM, NS	
2800 - Nobel Acabados: LP, LM, LA, BA, CM, CR, NS		2400 - Beta Acabados: AE, BL	

Puxadores

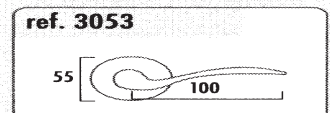
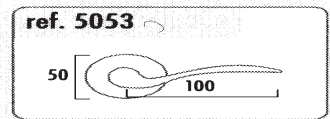
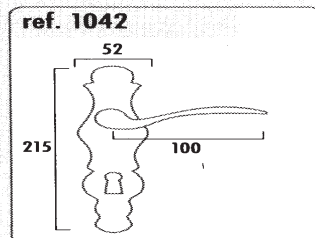
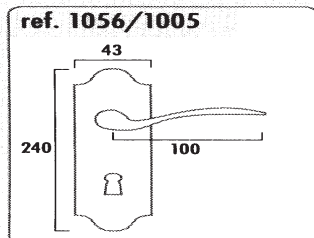
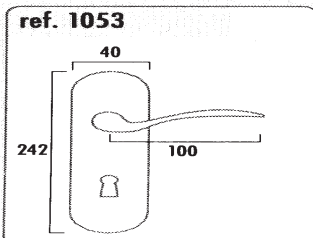
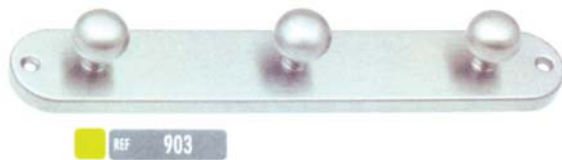

Puxadores



REF 603

REF 602

REF 601



REF 1360.80



REF 1351.80



REF 1350.80



REF 40.230

REF 40.300



REF 44



REF 47



REF 46



REF 48



REF 43

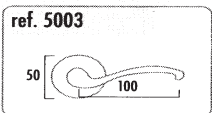
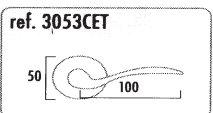
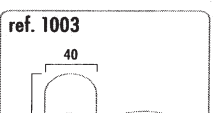
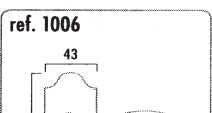
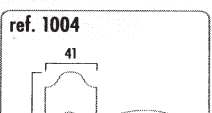
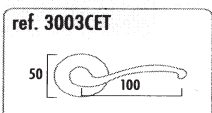
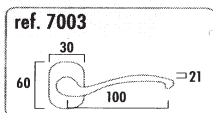
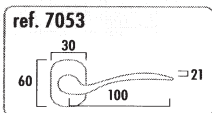

Puxadores

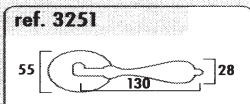
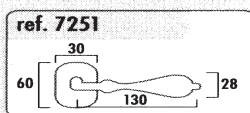
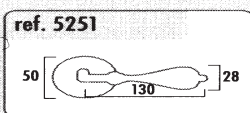
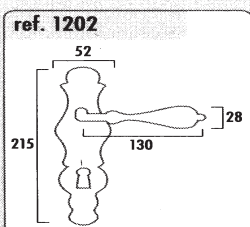
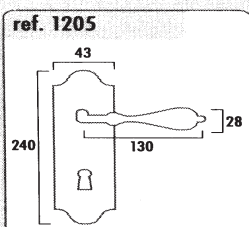
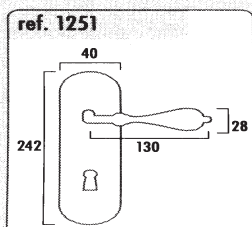

Puxadores

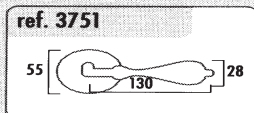
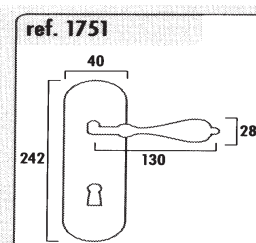
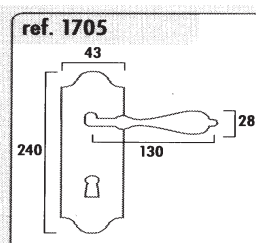
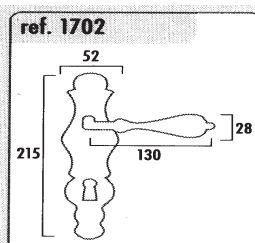
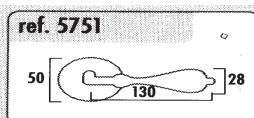
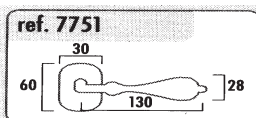

Puxadores

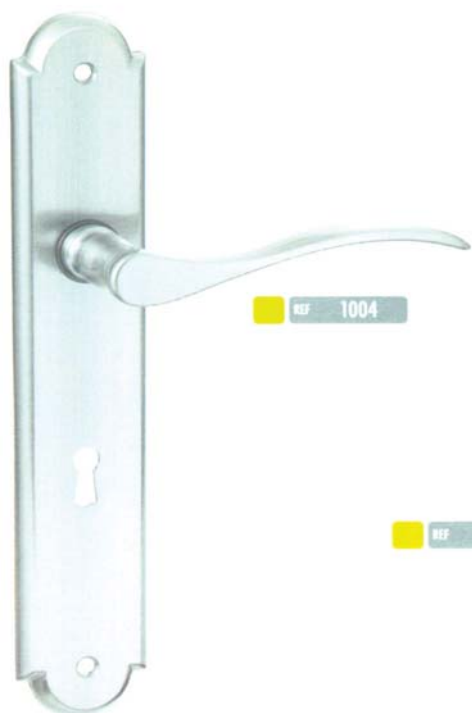



REF 1003

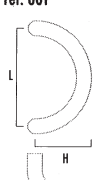

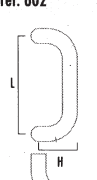
ref. 601	ref.	ø	L	H
	601/250	25	250	75

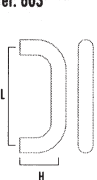
ref. 602	ref.	ø	L	H
	602/250	25	250	80
	602/300	25	300	80
	602/425	32	425	90

ref. 603	ref.	ø	L	H
	603/250	25	250	75
	603/300	25	300	75
	603/425	32	425	75

ref. 1350/1351.80	ref.	ø	L	H
	43	25	250	75
	44	25	300	75
	46	32	425	75
	47	25	250	80
	48	25	300	80
	40.230	25	250	80
	40.300	25	300	80

ref.	ø	L	H
43	25	250	75
44	25	300	75
46	32	425	75
47	25	250	80
48	25	300	80
40.230	25	250	80
40.300	25	300	80

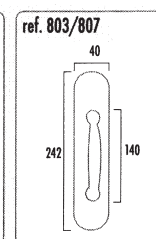
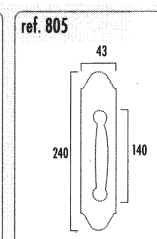
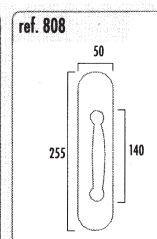
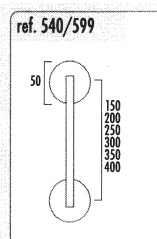
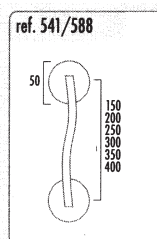
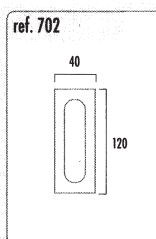
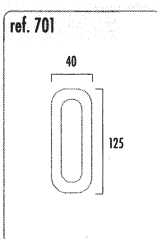
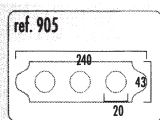
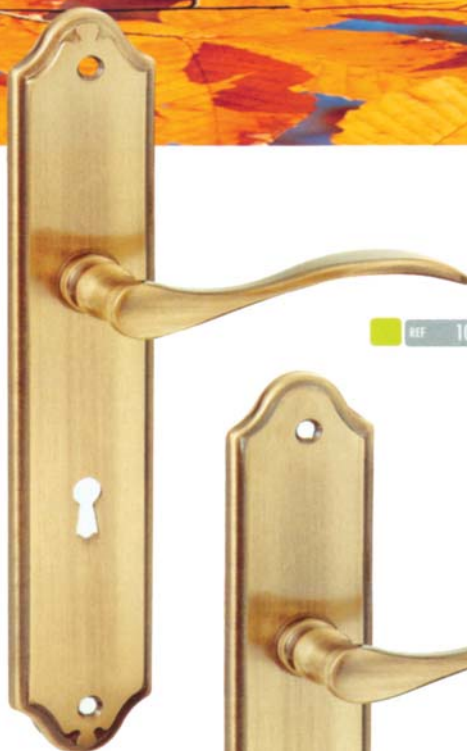
Puxadores

Asas e Puxadores



Ref. 4005/30



Ref. 4004/20



Ref. 4006/20



Ref. 4007



Ref. 4008



Ref. 4001



Ref. 4003

Ref. 6769



Ref. 6680/6738



Ref. 6738/80



Ref. 6738/120



Ref. 6680/50



Ref. 6680/50 cc

Asas e Puxadores

Ref. 781/50cc



Ref. 782/50cc



Ref. 783/50cc



Ref. 784/50cc



Ref. 792/50cc



Ref. 793/50cc



Ref. 4002



Ref. 776



Ref. 775/647



Ref. 766/647



Ref. 778



Ref. 766/727



Ref. 790/75

Asas e Puxadores



Ref. 754/A



Ref. 4002/A



Ref. 6680/A



Ref. 779/c



Ref. 780/c



Ref. 754/65



Ref. 754/120



Ref. 4009



Ref. 4010



Ref. 787



Ref. 789



Ref. 767



Ref. 791/ec



Ref. 762



Ref. 794/b

35mm



Ref. 794/d

35mm



Ref. 785

Asas e Puxadores

Ref. 688/50cc - cr./niq.esc.



Ref. 758/50cc - cr./cr.esc.



Ref. 704/50cc - cr./niq.esc.



Ref. 766/50cc - cr./cr.esc.



Ref. 752/50cc - cr./cr.esc.



Ref. 763/50cc



Ref. 766/50cc



Ref. 3203 inox



Ref. 688/A



Ref. 773

Asas e Puxadores



Ref. 631-50



Ref. 631-70



Ref. 632-50



Ref. 633-50



Ref. 642-50cc



Ref. 654-50



Ref. 656-50



Ref. 656-50cc



Ref. 661-50



Ref. 661-50cc



Ref. 662-50cc



Ref. 674-50



Ref. 676-50cc



Ref. 680-50



Ref. 687-50cc



Ref. 688-50cc



Ref. 688-A



Ref. 698-50



Ref. 698-50cc



Ref. 700-50cc



Ref. 702-50cc



Ref. 704-50cc



Ref. 709-50cc



Ref. 712-50cc



Ref. 713-50



Ref. 714-50cc



Ref. 715-50cc



Ref. 719-50cc



Ref. 720-50cc



Ref. 725-50cc



Ref. 727-50cc



Ref. 740-50cc



Ref. 741-50cc



Ref. 743-50cc



Ref. 746-50cc



Ref. 785



Ref. 4001



Ref. 4003



Ref. 4007



Ref. 4008



Ref. 6769

Puxador de latão bronze



Ref.ª 841

- 01 Cromado
- 05 Bronze**
- 06 Niquelado Preto
- 08 Lacado
- 11 Polido
- 16 Niquelado Mate
- 17 Cromado Mate
- 23 Niquel Escovado

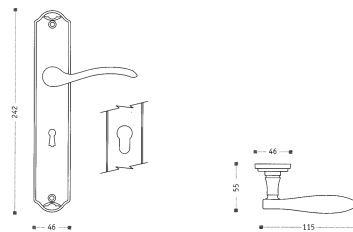

Puxador de latão bronze



Ref.ª 861

- 01 Cromado
- 05 Bronze**
- 06 Niquelado Preto
- 08 Lacado
- 11 Polido
- 16 Niquelado Mate
- 17 Cromado Mate
- 23 Niquel Escovado

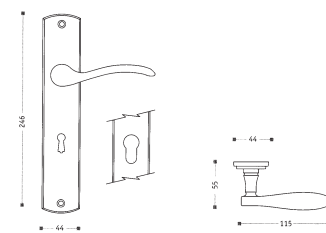

Puxador de latão bronze



Ref.ª 871

- 01 Cromado
- 05 Bronze**
- 06 Niquelado Preto
- 08 Lacado
- 11 Polido
- 16 Niquelado Mate
- 17 Cromado Mate
- 23 Niquel Escovado

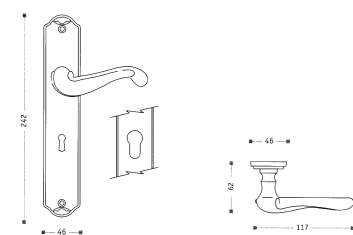

Puxador de latão bronze



Ref.ª 881

- 01 Cromado
- 05 Bronze**
- 06 Niquelado Preto
- 08 Lacado
- 11 Polido
- 16 Niquelado Mate
- 17 Cromado Mate
- 23 Niquel Escovado

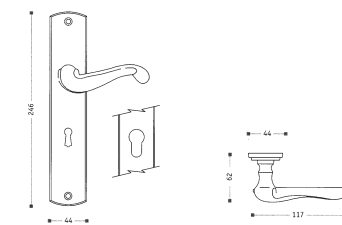

Puxador de latão bronze



Ref.ª 811

- 01 Cromado
- 05 Bronze**
- 06 Niquelado Preto
- 08 Lacado
- 11 Polido
- 16 Niquelado Mate
- 17 Cromado Mate
- 23 Niquel Escovado

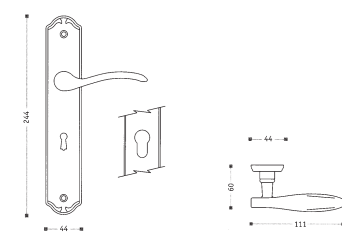

Puxador de latão cromado mate



Ref.ª 812

- 01 Cromado
- 05 Bronze**
- 06 Niquelado Preto
- 08 Lacado
- 11 Polido
- 16 Niquelado Mate
- 17 Cromado Mate**
- 23 Niquel Escovado

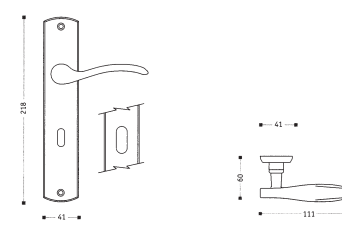

Puxador de latão niquelado mate



Ref.ª 813

- 01 Cromado
- 05 Bronze
- 06 Niquelado Preto
- 08 Lacado
- 11 Polido
- 16 Niquelado Mate
- 17 Cromado Mate
- 23 Niquel Escovado

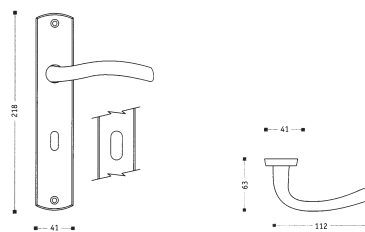

Puxador de latão niquelado mate



Ref.ª 814

- 01 Cromado
- 05 Bronze
- 06 Niquelado Preto
- 08 Lacado
- 11 Polido
- 16 Niquelado Mate
- 17 Cromado Mate
- 23 Niquel Escovado

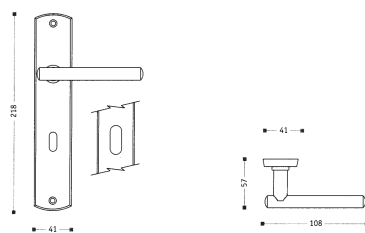

Puxador de latão cromado mate



Ref.ª 815

- 01 Cromado
- 05 Bronze
- 06 Niquelado Preto
- 08 Lacado
- 11 Polido
- 16 Niquelado Mate
- 17 Cromado Mate
- 23 Niquel Escovado

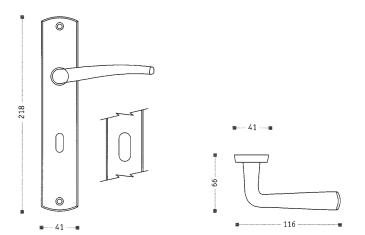

Puxador de latão niquel escovado



Ref.ª 816

- 01 Cromado
- 05 Bronze
- 06 Niquelado Preto
- 08 Lacado
- 11 Polido
- 16 Niquelado Mate
- 17 Cromado Mate
- 23 Niquel Escovado

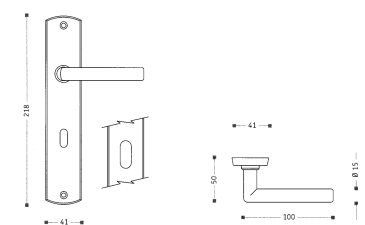

Puxador de latão cromado mate



Ref.ª 817

- 01 Cromado
- 05 Bronze
- 06 Niquelado Preto
- 08 Lacado
- 11 Polido
- 16 Niquelado Mate
- 17 Cromado Mate
- 23 Niquel Escovado

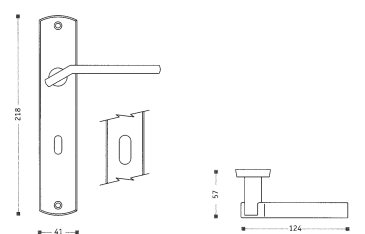

Puxador de latão niquel escovado



Ref.ª 822

- 01 Cromado
- 05 Bronze
- 06 Niquelado Preto
- 08 Lacado
- 11 Polido
- 16 Niquelado Mate
- 17 Cromado Mate
- 23 Niquel Escovado

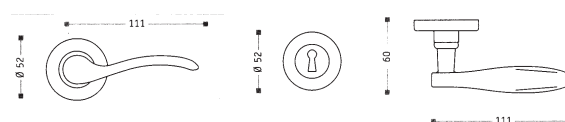

Puxador de latão niquelado mate



Ref.ª 823

- 01 Cromado
- 05 Bronze
- 06 Niquelado Preto
- 08 Lacado
- 11 Polido
- 16 Niquelado Mate**
- 17 Cromado Mate
- 23 Niquel Escovado



Puxador de latão niquel escovado



Ref.ª 824

- 01 Cromado
- 05 Bronze
- 06 Niquelado Preto
- 08 Lacado
- 11 Polido
- 16 Niquelado Mate
- 17 Cromado Mate
- 23 Niquel Escovado**

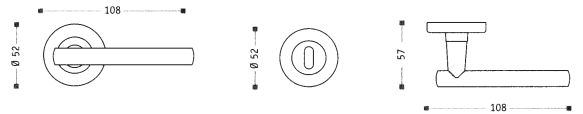

Puxador de latão bronze



Ref.ª 825

- 01 Cromado
- 05 Bronze**
- 06 Niquelado Preto
- 08 Lacado
- 11 Polido
- 16 Niquelado Mate
- 17 Cromado Mate
- 23 Niquel Escovado

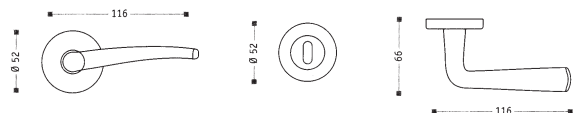

Dobradiça balanço lisa

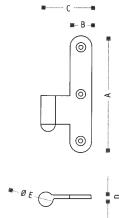

- 01 Cromado
- 05 Bronze
- 06 Niquelado Preto
- 08 Lacado
- 11 Polido
- 16 Niquelado Mate**
- 17 Cromado Mate
- 23 Niquel Escovado

	A	B	C	D	E	
3" B	3001	78.00	14.00	34.50	3.00	11.50
3,5" B	3002	92.30	17.00	39.80	3.00	11.50
4" B	3003	110.0	19.80	45.65	3.00	12.50

Dobradiça balanço rasa

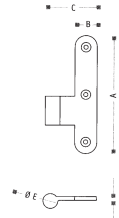
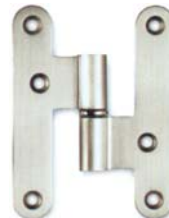

- 01 Cromado
- 05 Bronze
- 06 Niquelado Preto
- 08 Lacado
- 11 Polido
- 16 Niquelado Mate**
- 17 Cromado Mate
- 23 Niquel Escovado

	A	B	C	D	E	
3" B	3031	78.00	14.00	34.50	3.00	11.50
3,5" B	3032	92.30	17.00	39.80	3.00	11.50
4" B	3033	110.0	19.80	45.65	3.00	12.50

Dobradiça balanço lisa

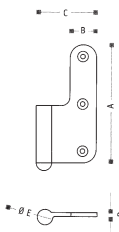

- 01 Cromado
- 05 Bronze
- 06 Niquelado Preto
- 08 Lacado
- 11 Polido
- 16 Niquelado Mate
- 17 Cromado Mate**
- 23 Niquel Escovado

	A	B	C	D	E	
3" B	3011	75.00	16.60	37.50	2.80	10.00
3,5" B	3012	87.50	19.60	44.35	3.00	11.50

Dobradiça balanço rasa

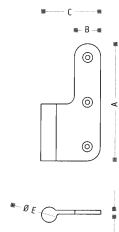

- 01 Cromado
- 05 Bronze
- 06 Niquelado Preto
- 08 Lacado
- 11 Polido
- 16 Niquelado Mate
- 17 Cromado Mate**
- 23 Niquel Escovado

	A	B	C	D	E	
3" B	3021	75.00	16.60	37.50	2.80	10.00
3,5" B	3022	87.50	19.60	44.35	3.00	11.50

Puxadores



Ref.ª 8000



Ref.ª 8001



Ref.ª 8004



Ref.ª 8036



Ref.ª 1974



Ref.ª 8002



Ref.ª 8005



Ref.ª 8037



Ref.ª 1975



Ref.ª 8003



Ref.ª 8006



Ref.ª 8038



Ref.ª 8016



Ref.ª 9001



Ref.ª 8013



Ref.ª 8039



Ref.ª 1965



Ref.ª 9003



Ref.ª 8021



Ref.ª 8043



Ref.ª 1966



Ref.ª 9002



Ref.ª 8014



Ref.ª 8045



Ref.ª 8009



Ref.ª 8011



Ref.ª 8015



Ref.ª 8024



Ref.ª 1961



Ref.ª 1976



Ref.ª 1972



Ref.ª 8035



Ref.ª 1962



Ref.ª 1977



Ref.ª 1973



Ref.ª 8025



Ref.ª 8010



Ref.ª 8012



Ref.ª 1968



Ref.ª 8007



Ref.ª 8008



Ref.ª 1963



Ref.ª 1970



Ref.ª 1968



Ref.ª 1616
1617



Ref.ª 1621
1622
1623



Ref.ª 1964



Ref.ª 1971



Ref.ª 1969



Ref.ª 508
503
501
502
506



Ref.ª 1618
1619
1920



Ref.ª 8054



Ref.ª 8040



Ref.ª 8041



Ref.ª 1624
1625
1626



Ref.ª 513
514
515



Ref.ª 8042



Ref.ª 8044



Ref.ª 8048

Puxadores

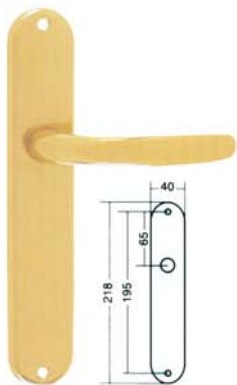

Ref. 860/355/03
(01,05)

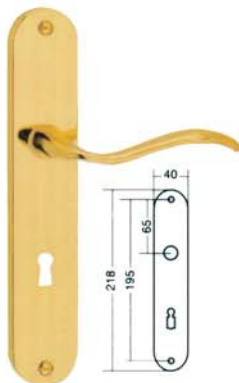

Ref. 840/355/01
(03)

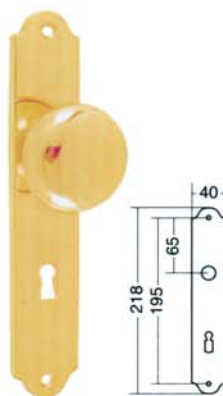

Ref. 293/425/01
(03,04,05)

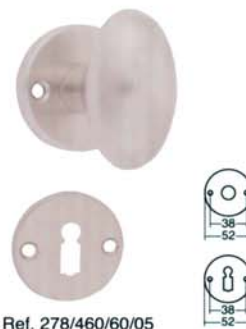

Ref. 278/460/60/05
(01,03,04)

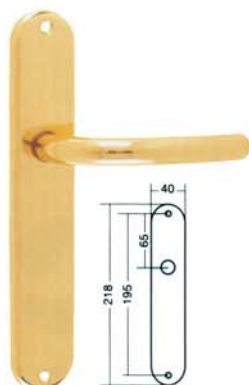

Ref. 295/355/01
(03,05)

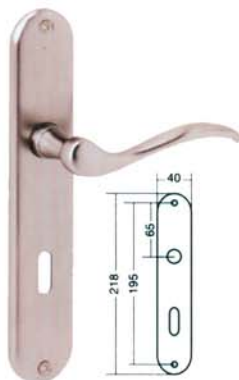

Ref. 288/355/05
(01,03)

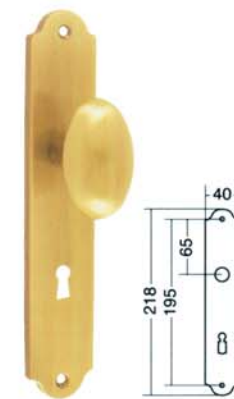

Ref. 278/425/03
(01,04,05)



Ref. 460/398/49/04
(01,03,05)

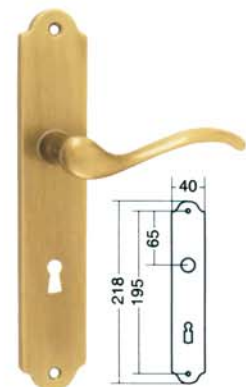

Ref. 130/105/03
Ref. 288/425/03
(01)



Ref. 1060/355/01
(03,05)

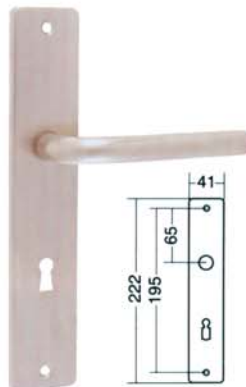

Ref. 460/85/05
(01,03,04)



Ref. 460/460/60/01
(03,04,05)



Ref. 670/398/49/04
(01,03,05)

Puxadores

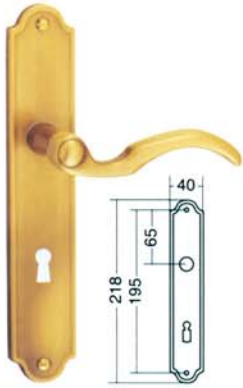

Ref. 40/135/03
(01)

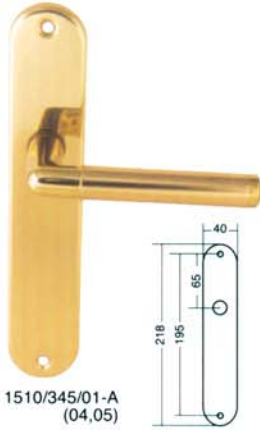

Ref. 1510/345/01-A
(04,05)



Ref. 1510/398/49/01-A
(04,05)

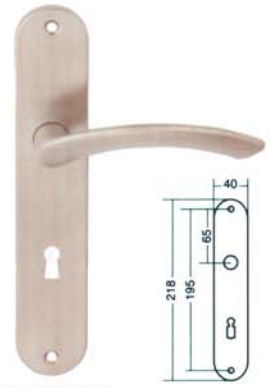

Ref. 180/95/05
(01,03)

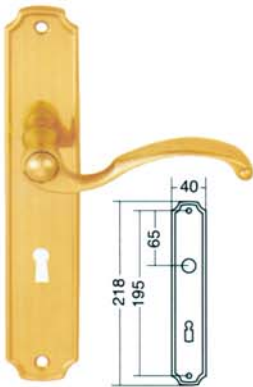

Ref. 370/115/01
(03)

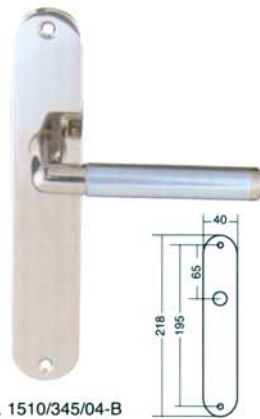

Ref. 1510/345/04-B
(01,05)



Ref. 1510/398/49/04-B
(01,05)



Ref. 180/398/49/05
(01,03)

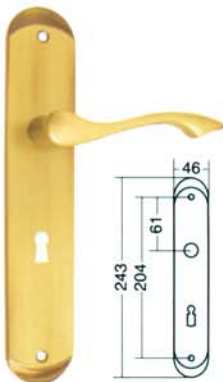

Ref. 296/459/03
(01)

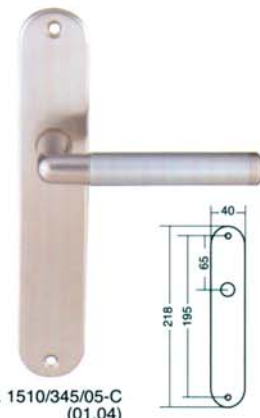

Ref. 1510/345/05-C
(01,04)



Ref. 1510/398/49/05-C
(01,04)

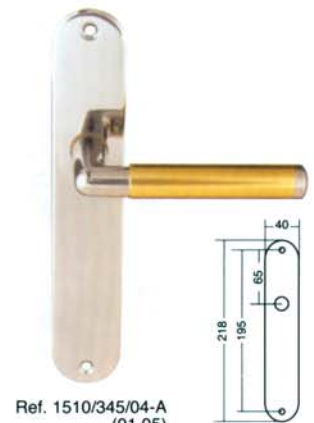

Ref. 1510/345/04-A
(01,05)

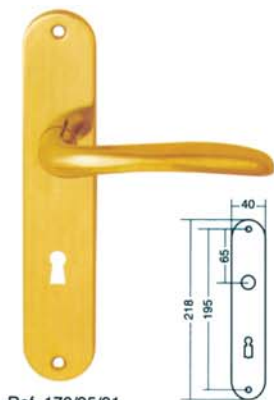
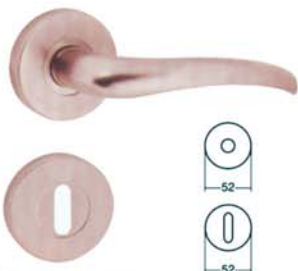
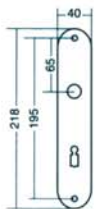
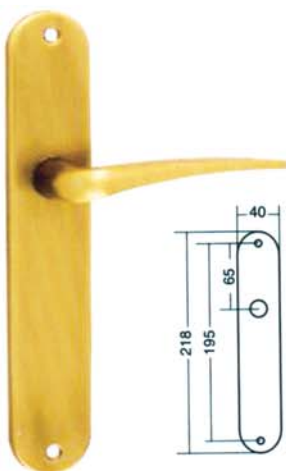
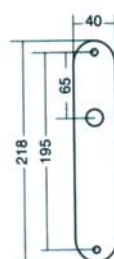
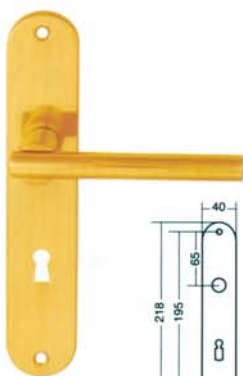
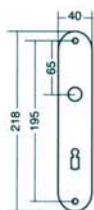
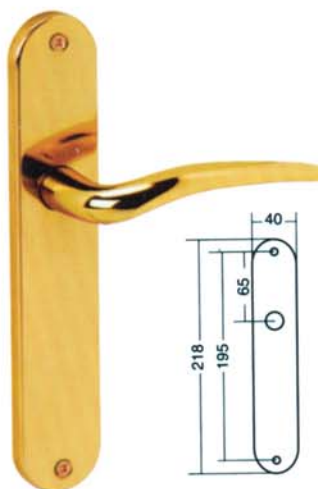
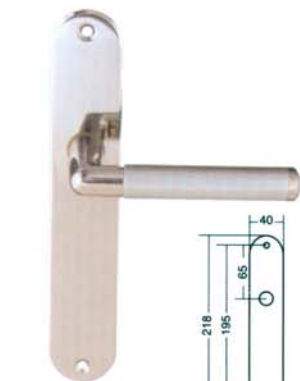
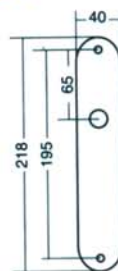
Puxadores

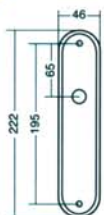
 Ref. 170/95/01
(03,04,05)

 Ref. 170/398/49/05
(01,03,04)

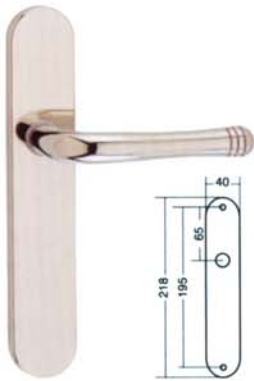
 Ref. 1470/345/03
(01,05)

 Ref. 1470/398/49/04
(01,05)

 Ref. 2002/95/01
(03,04,05)

 Ref. 2002/398/49/05
(01,03,04)

 Ref. 1610/95/01
(04,05)

 Ref. 1510/345/04-C
(01,05)

 Ref. 1480/265/01
(05)

 Ref. 1610/398/49/05
(01,04)



Puxadores



Ref. 990/95/04
(01,05)

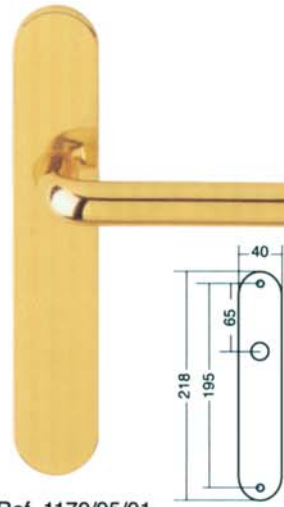

Ref. 990/398/49/01
(04,05)



Ref. 1170/95/01
(05) (06)

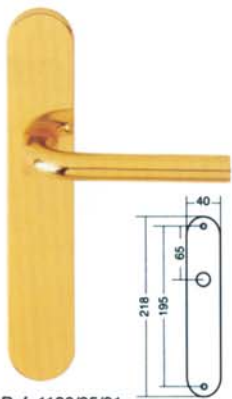

Ref. 1130/95/01
(05)



Ref. 1130/398/49/05
(01)



Ref. 1170/398/49/05
(01)

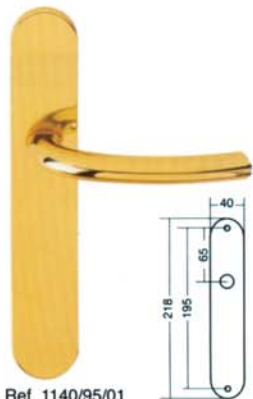

Ref. 1140/95/01
(05)

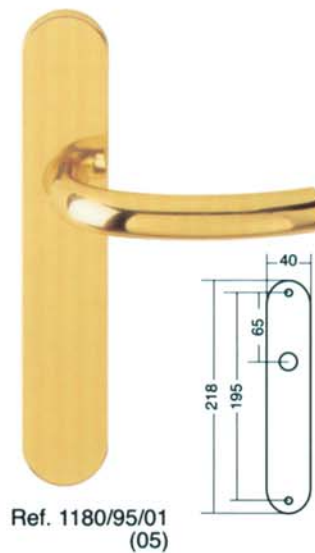

Ref. 1180/95/01
(05)



Ref. 1140/398/49/05
(01)



Ref. 1180/398/49/05
(01)

Puxadores



Ref. 579/03
(01,04,05)

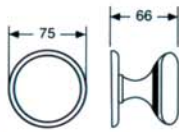

Ref. 971/03
(01,04,05)

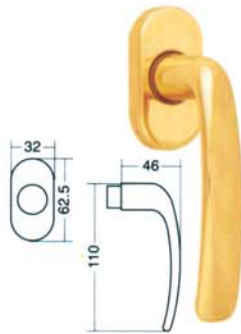

Ref. CR 40/01
(03,04,05)



Ref. 716/4

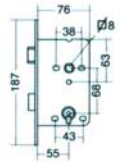

Ref. 968/376/01
(03,05)



Ref. 968/398/05
(01,03)



Ref. 976/05
(01,03,04)

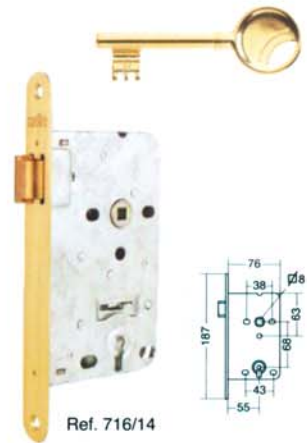

Ref. 716/14

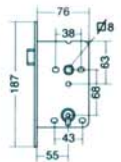

Ref. 622/01
(02,03,04,05,06,F1)



Ref. 623/05
(01,02,03,04,06,F1)



Ref. 970/01
(03,04,05)

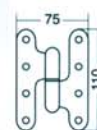

Ref. 716/5 (15)

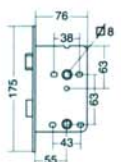

Ref. 624/03
(01,02,04,05,06,F1)



Puxadores



Ref. 2/35/01



Ref. 2/35/02



Ref. 2/35/03



Ref. 2/35/04



Ref. 2/35/05



Ref. 2/35/06



Ref. 2/35/07



Ref. 4/25/01



Ref. 4/25/02



Ref. 4/25/03



Ref. 4/25/04



Ref. 4/25/05



Ref. 4/25/06



Ref. 4/25/07



Ref. 651/03
(01,04,05)



Ref. 652/03
(01,04,05)



Ref. 653/03
(01,04,05)



Ref. 654/03
(01,04,05)



Ref. 790/01
(03,04,05)



Ref. 789/04
(01,03,05)



Ref. 788/05
(01,03,04)



Ref. 3/30/01



Ref. 3/30/02



Ref. 3/30/03



Ref. 3/30/04



Ref. 3/30/05



Ref. 3/30/06



Ref. 3/30/07



Ref. 5/30/01



Ref. 5/30/02



Ref. 5/30/03



Ref. 5/30/04



Ref. 5/30/05



Ref. 5/30/06



Ref. 5/30/07



Ref. 651/374/05
(01,03)



Ref. 651/419/05
(01,03)



Ref. 651/377/03
(01,05)



Ref. 651/375/03
(01,05)



Ref. 517/01
(03)



Ref. 509/01
(03)



Ref. 511/01
(03)

Puxadores

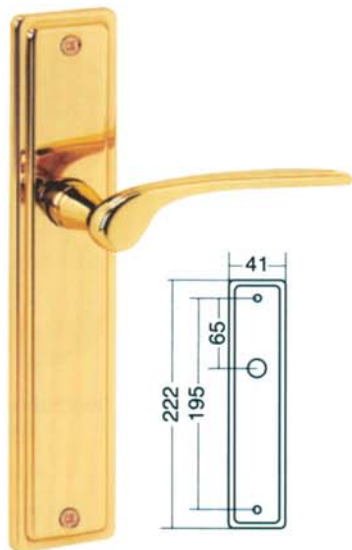

Ref. 1280/275/01
(05)

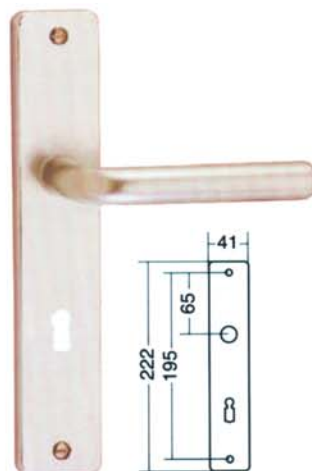

Ref. 5000/5015/F1 ø18



Ref. 5030/5095/5125/F1 ø18



Ref. 1290/275/05
(01)



Ref. 1290/285/295/01
(05)

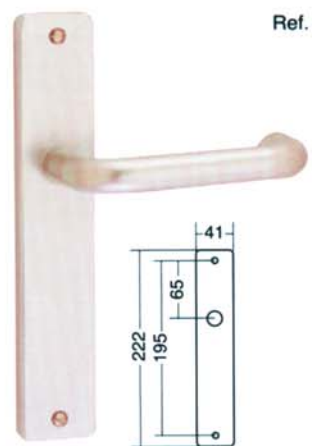

Ref. 5030/5015/F1 ø18

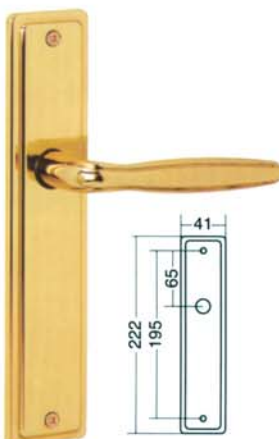

Ref. 1310/275/01
(03,05)



Ref. 1310/285/295/03
(01,05)

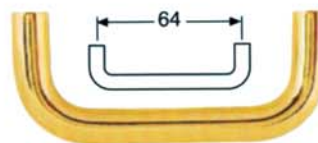

Ref. 688/01
(03,04,05)

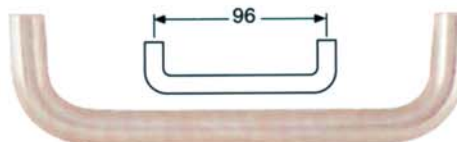

Ref. 689/05
(01,03,04)

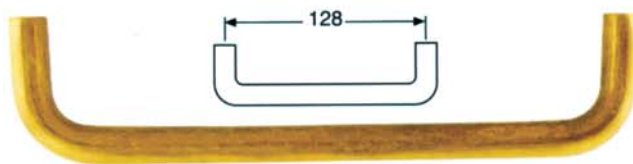

Ref. 690/03
(01,04,05)

Puxadores

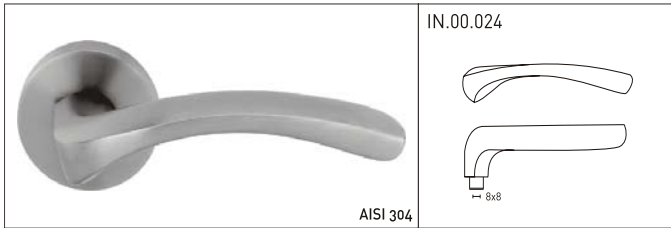

Serie Carlo

Rosetas disponíveis | Available roses | Rosetas disponíveis
RA08N



Serie Estoril

Rosetas disponíveis | Available roses | Rosetas disponíveis



Serie Nord

Rosetas disponíveis | Available roses | Rosetas disponíveis



Serie Linear

Rosetas disponíveis | Available roses | Rosetas disponíveis

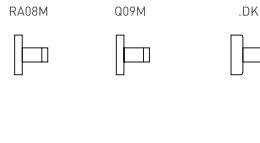

.SR
com placa
to use with plate

Puxadores

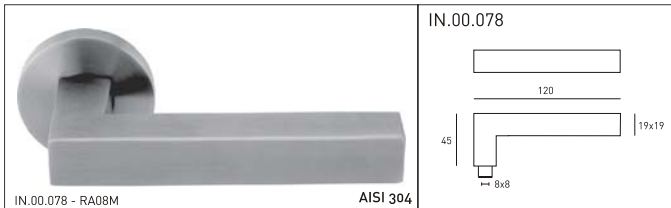

Serie Quadro

IN.00.078 - RA08M

AISI 304



Serie Metric

AISI 304

IN.00.107- RA08M

design JNF

RA08M Q09M .DK

.SR
com placa
to use with plate

design Miguel Vasconcelos

RA08M Q09M .DK



IN.00.078 - Q09M



AISI 304

IN.00.107- Q09M

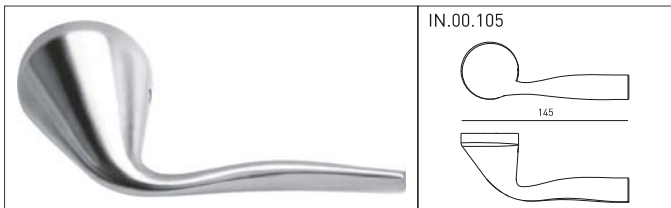

Serie Twins

AISI 304

design Miguel Vasconcelos



Serie Soft

AISI 304

design JNF

RA08M .DK

.SR
com placa
to use with plate



Rosetas disponíveis | Available roses | Rosetas disponíveis

Puxadores

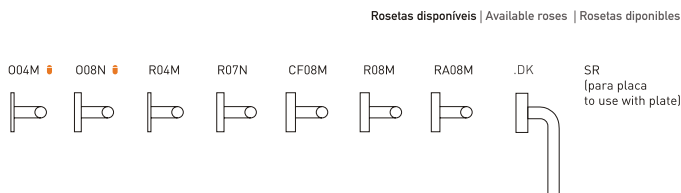

Rosetas disponíveis | Available roses | Rosetas disponibles

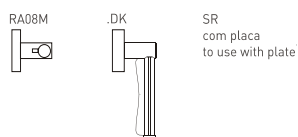

Serie Skin

design Susana Ribeiro

pele natural
natural leather
cuero natural

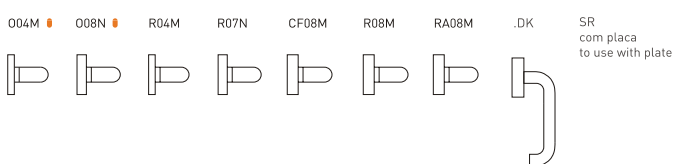

Puxadores

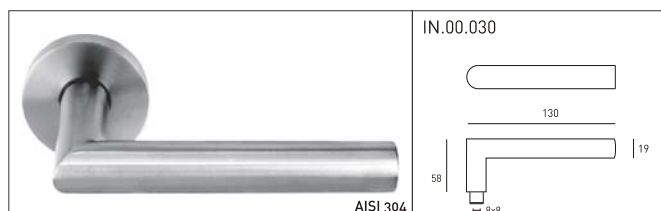

Rosetas disponíveis | Available roses | Rosetas disponibles

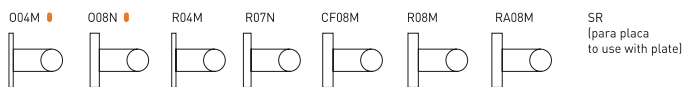

Rosetas disponíveis | Available roses | Rosetas disponibles

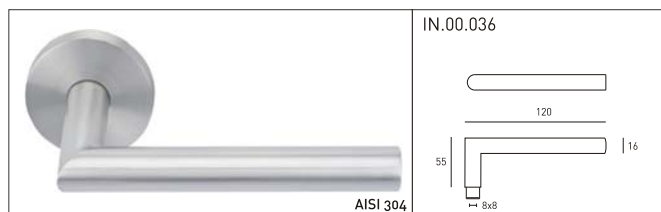
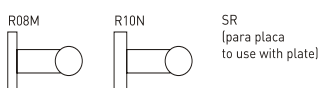

Rosetas disponíveis | Available roses | Rosetas disponibles

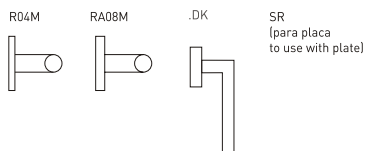

Rosetas disponíveis | Available roses | Rosetas disponibles



Puxadores

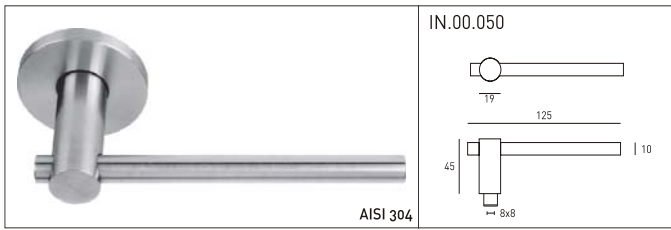

IN.00.050

AISI 304



IN.00.234

Base em nylon e fixações ocultas
Nylon base and concealed fixings
Base en nylon e fijaciones ocultas

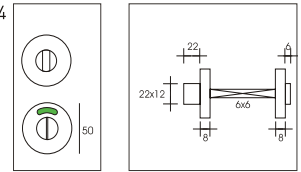

Indicador "Livre/Ocupado" Verde/Vermelho
"Engaged/Free" indicator with Red/Green Colour
Indicador de "Libre/Ocupado" en color Verde/Rojo

Rosetas disponíveis | Available roses | Rosetas disponibles

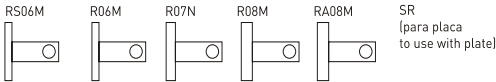

IN.00.236

Base em nylon e fixações ocultas
Nylon base and concealed fixings
Base en nylon e fijaciones ocultas

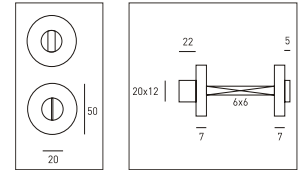

Sem indicador de cor "Livre/Ocupado"
Without colour indicator "Engaged/Free"
Sin el indicador de color "Libre/Ocupado"



IN.00.051

AISI 304

Rosetas disponíveis | Available roses | Rosetas disponibles

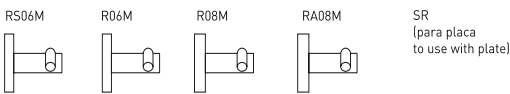

IN.00.238

Base em nylon e fixações ocultas
Nylon base and concealed fixings
Base en nylon e fijaciones ocultas

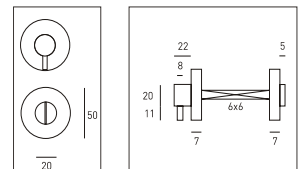

Sem indicador de cor "Livre/Ocupado"
Without colour indicator "Engaged/Free"
Sin el indicador de color "Libre/Ocupado"

Puxadores

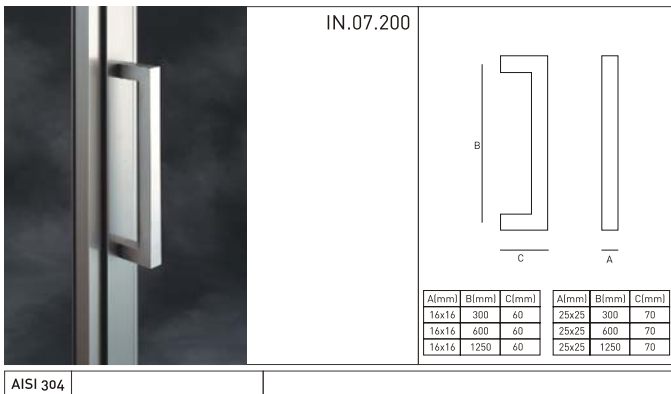

IN.07.200

AISI 304

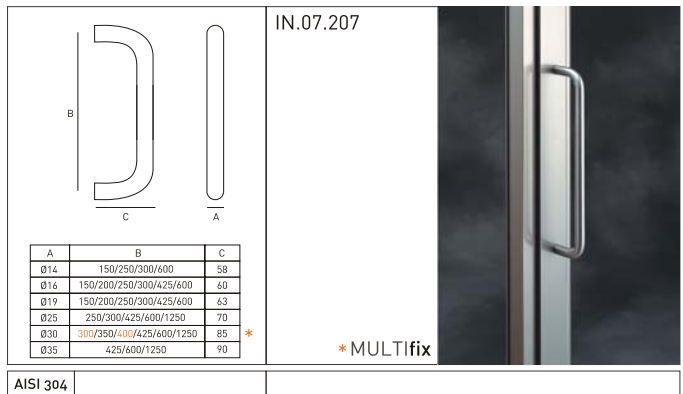

IN.07.207

AISI 304

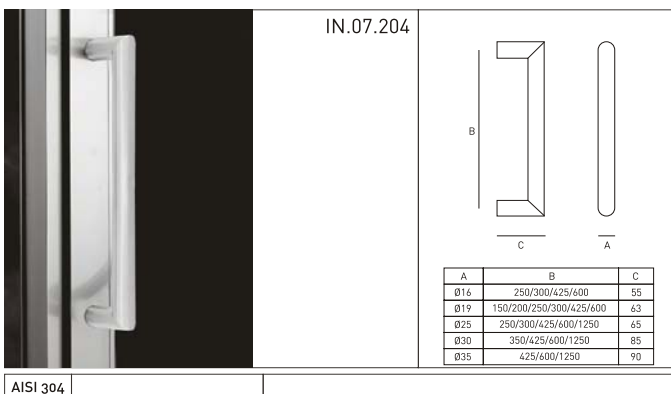

IN.07.204

AISI 304



IN.07.286

AISI 304

Fixações disponíveis - consultar página 146
Available fixing - please refer to page 146
Fijación disponible - consultar página 146

Fixações disponíveis - consultar página 146
Available fixing - please refer to page 146
Fijación disponible - consultar página 146

Puxadores

IN.07.287

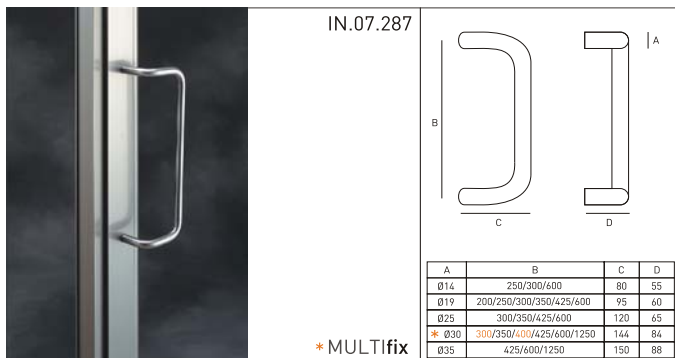

A	B	C	D
Ø14	250/300/600	80	55
Ø19	200/250/300/350/425/600	95	60
Ø25	300/350/425/600	120	65
* Ø30	300/350/425/600/1250	144	84
Ø35	425/600/1250	150	88

* MULTifix

AISI 304

IN.07.289

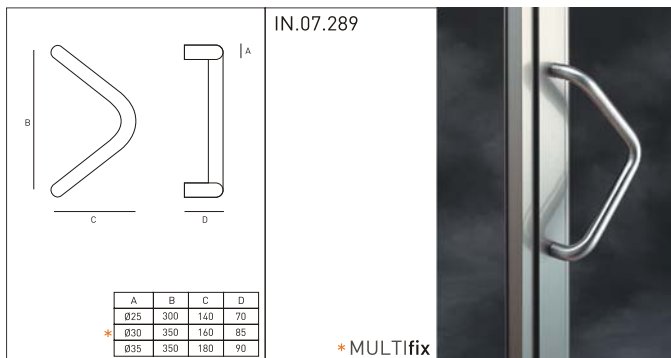

A	B	C	D
Ø25	300	140	70
Ø30	350	160	85
Ø35	350	180	90

* MULTifix

AISI 304

IN.07.288

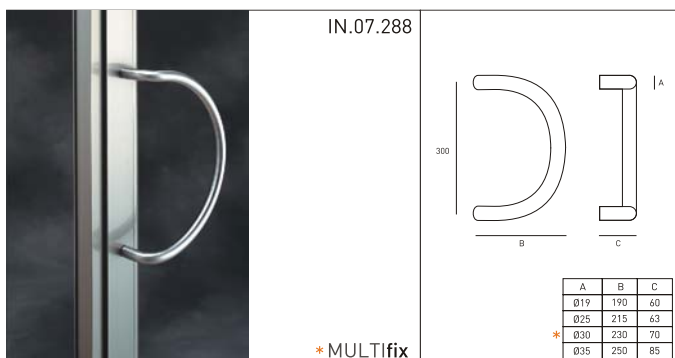

A	B	C
Ø19	190	60
Ø25	215	63
Ø30	230	70
Ø35	250	85

* MULTifix

AISI 304

IN.07.290

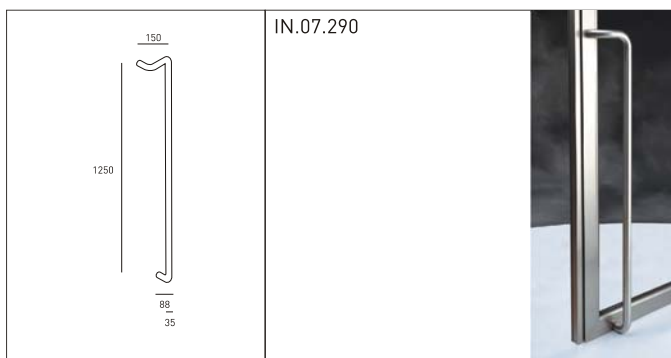

150
1250
88
35

AISI 304

Fixações disponíveis - consultar página 146
Available fixing - please refer to page 146
Fijación disponible - consultar página 146

Fixações disponíveis - consultar página 146
Available fixing - please refer to page 146
Fijación disponible - consultar página 146

Puxadores e dobradiças

IN.07.291

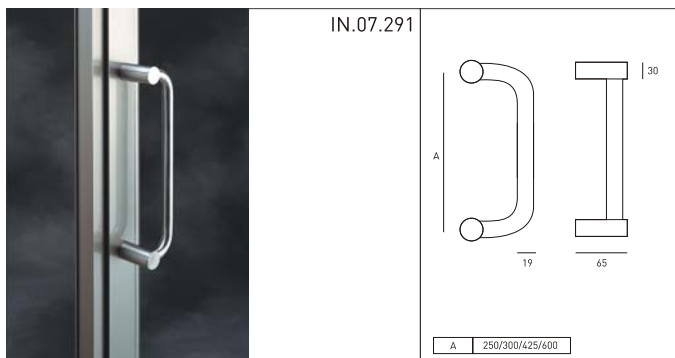

A	B
250/300/425/600	

AISI 304

IN.05.016



20
90
75
12
± 2,5

Dobradiça de balanço. Direita ou esquerda
Lift off hinge. Right or left hand
Bisagra Derecha o izquierda

AISI 304 Carga máx. | Max. Load | Capacidad 50KG

IN.07.292

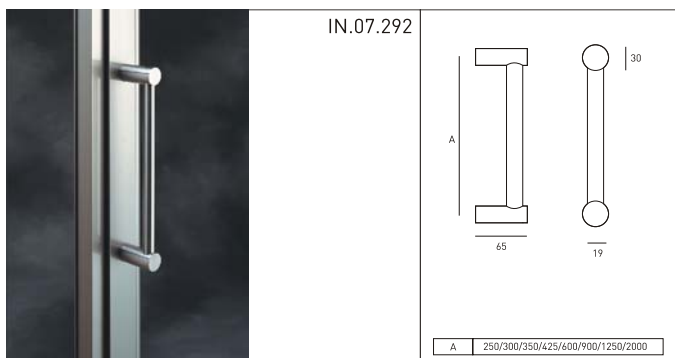

A	B
250/300/350/425/600/900/1250/2000	

AISI 304

IN.05.017

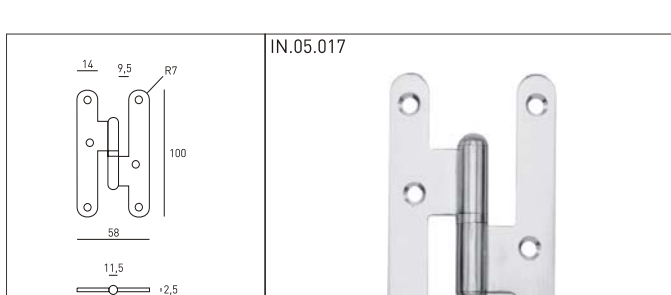

14 9,5 R7
100
58
11,5
± 2,5

Dobradiça com cantos arredondados.
Direita ou esquerda
Hinge with round corners.
Right or left hand
Bisagra de pala redonda.
Derecha o izquierda

AISI 304 Carga máx. | Max. Load | Capacidad 30KG

Fixações disponíveis - consultar página 146
Available fixing - please refer to page 146
Fijación disponible - consultar página 146

Dobradiças

	<p>IN.05.019.75</p>		<p>IN.05.019.90.B</p>
<p>Dobradiça de meio balanço. Direita ou esquerda Lift off hinge .Right or left hand Bisagra Derecha o izquierda</p>	<p>Carga máx. Max. Load Capacidad 40KG</p>	<p>Dobradiça de meio balanço. Direita ou esquerda Lift off hinge .Right or left hand Bisagra Derecha o izquierda</p>	<p>Carga máx. Max. Load Capacidad 50KG</p>
<p>AISI 304</p>		<p>AISI 304</p>	

<p>IN.05.019.75.R</p>			<p>IN.05.019.90.BR</p>
<p>Dobradiça de meio balanço. Direita ou esquerda Lift off hinge .Right or left hand Bisagra Derecha o izquierda</p>	<p>Carga máx. Max. Load Capacidad 40KG</p>	<p>Dobradiça de meio balanço com cantos redondos. Direita ou esquerda Hinge with round corners. Right or left hand Bisagra de pala redonda. Derecha o izquierda</p>	<p>Carga máx. Max. Load Capacidad 50KG</p>
<p>AISI 304</p>		<p>AISI 304</p>	

Fechaduras

<p>IN.20.795</p> <p>Fechadura de embutir com cilindro europeu. Trinco Silencioso reversivel. Frente e chapa testa em Aço Inox AISI 304. Trinco e Língua em latão Cromado. Fornecida com cilindro normal Ref.:5200 com 60 mm. Indicada para portas de entrada ou com uso muito frequente.</p> <p>Mortise door lock with european cylinder. With Silent adjustable latch. Front plate and strike plate made in Stainless Steel AISI 304. Latch and dead bolt made in solid Brass Chrome plated. Supplied with cylinder Ref.5200 size 60mm. Recommended for entrance doors with heavy use.</p> <p>Cerradura de embutir con Bombillo europeo. Picaporte Silencioso reversible. Frente y cerradero en Acero Inox AISI 304. Picaporte y pestillo en Laton Cromado. Suministrada con bombillo Ref.:5200 de 60 mm. Indicada para puertas de entrada con uso muy frecuente.</p>		<p>IN.20.796</p> <p>Fechadura de embutir para casa de banho. Trinco Silencioso reversivel. Frente e chapa testa em Aço Inox AISI 304. Trinco e Língua em Latão Cromado. Indicada para portas com uso muito frequente.</p> <p>Mortise door lock for bathroom use. With Silent adjustable latch. Front plate and strike plate made in Stainless Steel AISI 304. Latch and dead bolt made in solid Brass Chrome plated. Recommended for doors with heavy use.</p> <p>Cerradura de embutir para baño. Picaporte Silencioso reversible. Frente y cerradero en Acero Inox AISI 304. Picaporte y pestillo en Laton Cromado. Indicada para puertas con uso muy frecuente.</p>	
<p>AISI 304</p>		<p>AISI 304</p>	

Fechaduras

IN.20.797



Fechadura de passagem.
Trinco Silencioso reversível.
Frente e chapa testa em Aço Inox AISI304.
Trinco em Latão Cromado.
Indicada para portas com uso muito frequente.

Mortise door lock passage type.
With Silent adjustable latch.
Front plate and strike plate made in Stainless Steel AISI 304.
Latch made in solid Brass Chrome plated.
Recommended for doors with heavy use.

Cerradura de embutir para puertas de paso.
Picaporte Silencioso reversible.
Frente y cerradero en Acero Inox AISI 304.
Picaporte en Latón Cromado.
Indicada para puertas con uso muy frecuente.

Passagem Passage Type
GRADE 3
Silent
170
38
8x8
1 pcs
30 pcs

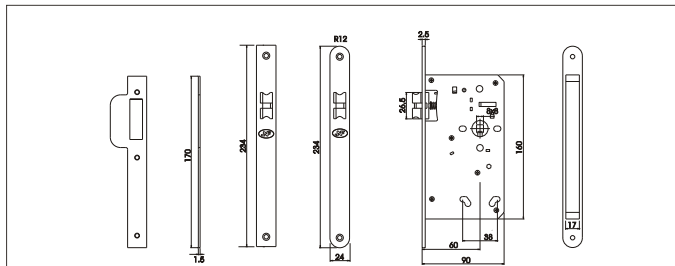

AISI 304

IN.20.798



Fechadura de embutir para portas interiores.
Chave com 12 combinações.
Trinco Silencioso reversível.
Frente e chapa testa em Aço Inox AISI304.
Trinco e Língua em Latão Cromado.
Indicada para portas com uso muito frequente.

Mortise lock for internal doors.
Key with 12 different combinations.
With Silent adjustable latch.
Front plate and strike plate made in Stainless Steel AISI 304.
Latch and dead bolt made in solid Brass Chrome plated.
Recommended for doors with heavy use.

Cerradura de embutir para puertas de interior.
Llave de borjas con 12 combinaciones.
Picaporte Silencioso reversible.
Frente y cerradero en Acero Inox AISI304.
Picaporte y pestillo en Latón Cromado.
Indicada para puertas con uso muy frecuente.

GRADE 3
Silent
170
38
8x8
1 pcs
30 pcs

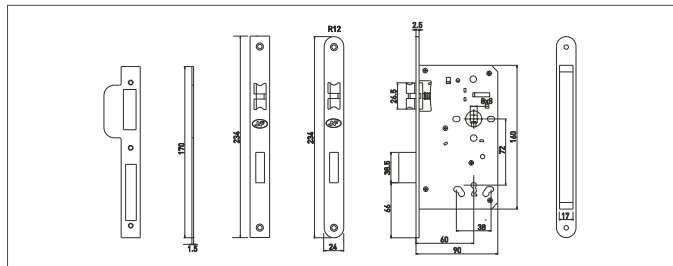

AISI 304

Fechaduras

IN.20.815



Fechadura de embutir para cilindro Europeu
Indicada para portas de entrada ou interior com uso muito frequente

Mortise door lock for European cylinder
Recommended for entrance doors with heavy use

Cerradura de embutir para bombillo Europeo
Indicada para puertas de entrada con uso muy frecuente.

GRADE 3
Silent
170
38
8x8
1 pcs
30 pcs

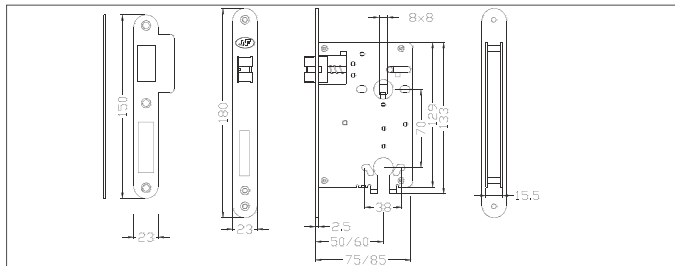

AISI 304

IN.20.816



Fechadura de embutir para portas interiores
Chave com 12 combinações
Bloqueio através do trinco
Indicada para portas com uso muito frequente

Mortise door lock for internal doors
Key with 12 different combinations
Locking system through the latch
Recommended for doors with heavy use

Cerradura de embutir para puertas de interior
Llave con 12 combinaciones
Bloqueo por intermedio del pestillo
Indicada para puertas con uso muy frecuente.

GRADE 3
Silent
170
38
8x8
1 pcs
30 pcs

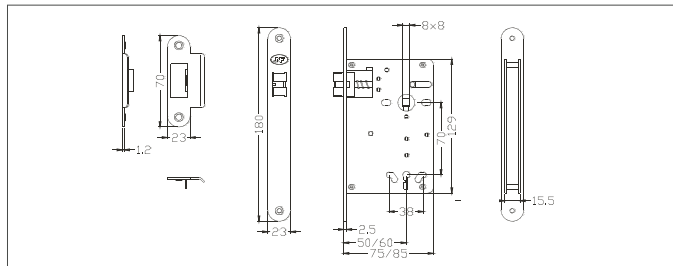

AISI 304

Fechaduras

IN.20.817



Fechadura de embutir para casa de banho
Bloqueio através do trinco
Indicada para portas com uso muito frequente

Mortise door lock for bathroom use
Locking system through the latch
Recommended for doors with heavy use

Cerradura de embutir de condena
Bloqueo por intermedio del pestillo
Indicada para puertas con uso muy frecuente.

WC 8x4 GRADE 3 Silent 1 38 8x4 1 pcs 30 pcs

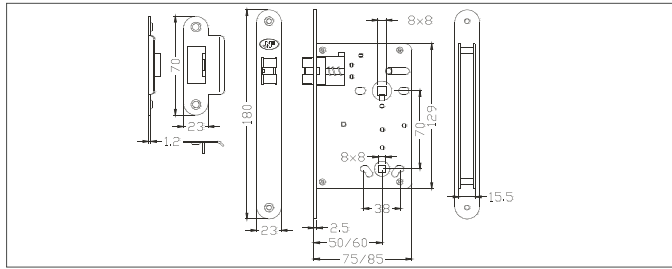

AISI 304

IN.20.916



Fechadura de embutir para portas interiores, com chave normal.
Trinco Silêncioso reversível fabricado em Aço Inox.
A alavanca que toca no aro é fabricada em nylon para eficácia acrescida na redução de ruído.
Frente em Aço Inox Fundido a Alta Pressão AISI 304.
Chapa testa em Aço Inox AISI 304.
Trinco e Língua em Aço Inox AISI 304.
Quadra para puxador em Aço Inox AISI304.
Quadra para puxador com sistema que elimina a folga existente entre puxador e fechadura.
Pode ser instalada com puxadores sem mola.
Indicada para portas com uso extremo.

Mortise door lock for internal doors.
With Silent adjustable latch made in Stainless Steel.
Front plate and strike plate made in S. Steel AISI 304.
Latch and dead bolt made in solid S. Steel AISI 304.
Square hole for the handle made in solid Stainless Steel with a internal spring to avoid any breakage between the sprindile and the lock.
Recommended for doors with heavy use.

Cerradura de embutir para puertas de interior con llave de borjas.
Picaporte Silencioso reversible fabricado en A. Inox.
Frente y cerradero en Acero Inox AISI 304.
Picaporte y pestillo en Acero Inox.
Nueca en Acero Inox con muelle interior para eliminar la holgura entre manilla y nueca.
Indicada para puertas con uso muy intenso.

WC 8x4 GRADE 4 Silent 1 38 8x4 1 pcs 30 pcs

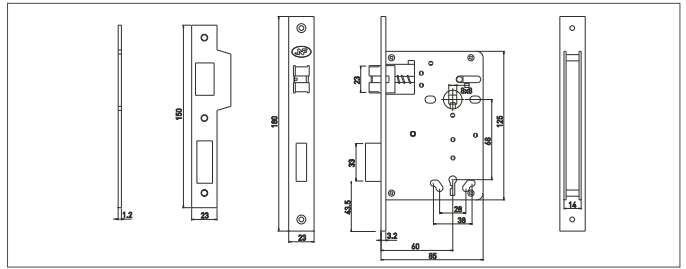

AISI 304

Fechaduras e barras anti-pânico

IN.20.917



Fechadura de embutir para casa de banho.
Trinco Silêncioso reversível fabricado em Aço Inox.
A alavanca que toca no aro é fabricada em nylon para eficácia acrescida na redução de ruído.
Frente em Aço Inox Fundido a Alta Pressão AISI 304.
Chapa testa em Aço Inox AISI 304.
Trinco e Língua em Aço Inox AISI 304.
Quadra para puxador em Aço Inox AISI 304.
Quadra para puxador com sistema que elimina a folga existente entre puxador e fechadura.
Podem ser instaladas com puxadores sem mola.
Indicada para portas com uso extremo.

Mortise door lock with bathroom function.
With Silent adjustable latch made in Stainless Steel.
Front plate and strike plate made in S. Steel AISI 304.
Latch and dead bolt made in solid S. Steel AISI 304.
Square hole for the handle made in solid Stainless Steel with a internal spring to avoid any breakage between the sprindile and the lock.
Recommended for internal doors with heavy use.

Cerradura de embutir con condena de baño.
Picaporte Silencioso reversible fabricado en A. Inox.
Frente y cerradero en Acero Inox AISI 304.
Picaporte y pestillo en Acero Inox.
Nueca en Acero Inox con muelle interior para eliminar la holgura entre manilla y nueca.
Indicada para puertas con uso muy intenso.

WC 8x4 GRADE 4 Silent 1 38 8x4 1 pcs 30 pcs

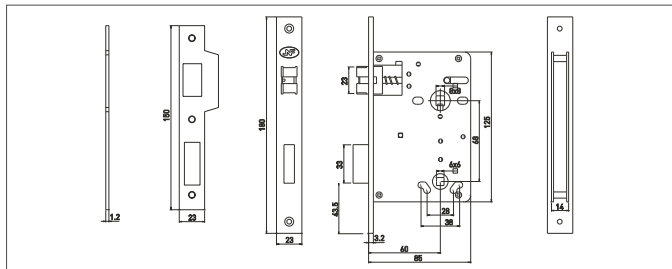

AISI 304

IN.20.910



Barra Anti-Pânico Reversível para porta de 1 Folha.
Fecho através de Trinco Lateral.
Sem funcionamento através do exterior
Antipanic Reversible Lock for Single Doors.
Closing System through a Side Latch.
Without Access from External Side
Cerradura Antipánico Reversible para Puertas de 1 Hoja
Cierre por Picaporte Basculante Lateral.
Sin Funcionamiento por el Exterior:

IN.20.911



Barra Anti-Pânico Reversível para porta de 1 Folha.
Fecho através de Trinco Lateral.
Por Chave, com Puxador Fixo através do exterior
Antipanic Reversible Lock for Single Doors.
Closing System through a Side Latch.
With Key and Fixed Knob from External Side
Cerradura Antipánico Reversible para Puertas de 1 Hoja
Cierre por Picaporte Basculante Lateral.
Por Llave con Pomo Fijo por el Exterior:

IN.20.912



Barra Anti-Pânico Reversível para porta de 1 Folha.
Fecho através de Trinco Lateral.
Por Chave e Puxador Rotativo através do exterior
Antipanic Reversible Lock for Single Doors.
Closing System through a Side Latch.
With Key and Lever Handle from External Side
Cerradura Antipánico Reversible para Puertas de 1 Hoja.
Cierre por Picaporte Basculante Lateral.
Por Llave y Manilla por el Exterior:

Barras Acopláveis à Ref. IN.20.930 para Portas de 2 Folhas.
This Locks can be installed with the Ref. IN.20.930 for Double Doors.
Estas Cerradura pueden ser Acopladas a la Ref. IN.20.930 para Puertas de 2 Hojas

39 208 30 14.5

Fechaduras Anti-Pânico Certificadas segundo a Norma Europeia EN1125.
Materiais de Fabrico : Caixas Ext., Barras e Tubo Transversal fabricados em Aço Inox AISI 304.
Acabamento Escovado. Mecanismos Internos em Aço Galvanizado.

Antipanic Locks for Exit Doors Certified Accordingly to the European Norm EN1125.
The Covers, External Bares and Arms are made in Stainless Steel AISI 304 Satin Finish.
The Internal Mechanism It's made in Galvanized Steel.

Cerraduras Antipânico Certificadas Segundo la Norma Europea EN1125.
Las Cajas Ext., Brazos y Barras son Fabricados en Acero Inox AISI 304 Acabado Satinado.
Los Mecanismos Interiores son Fabricados en Acero Galvanizado.

EN 1125

AISI 304

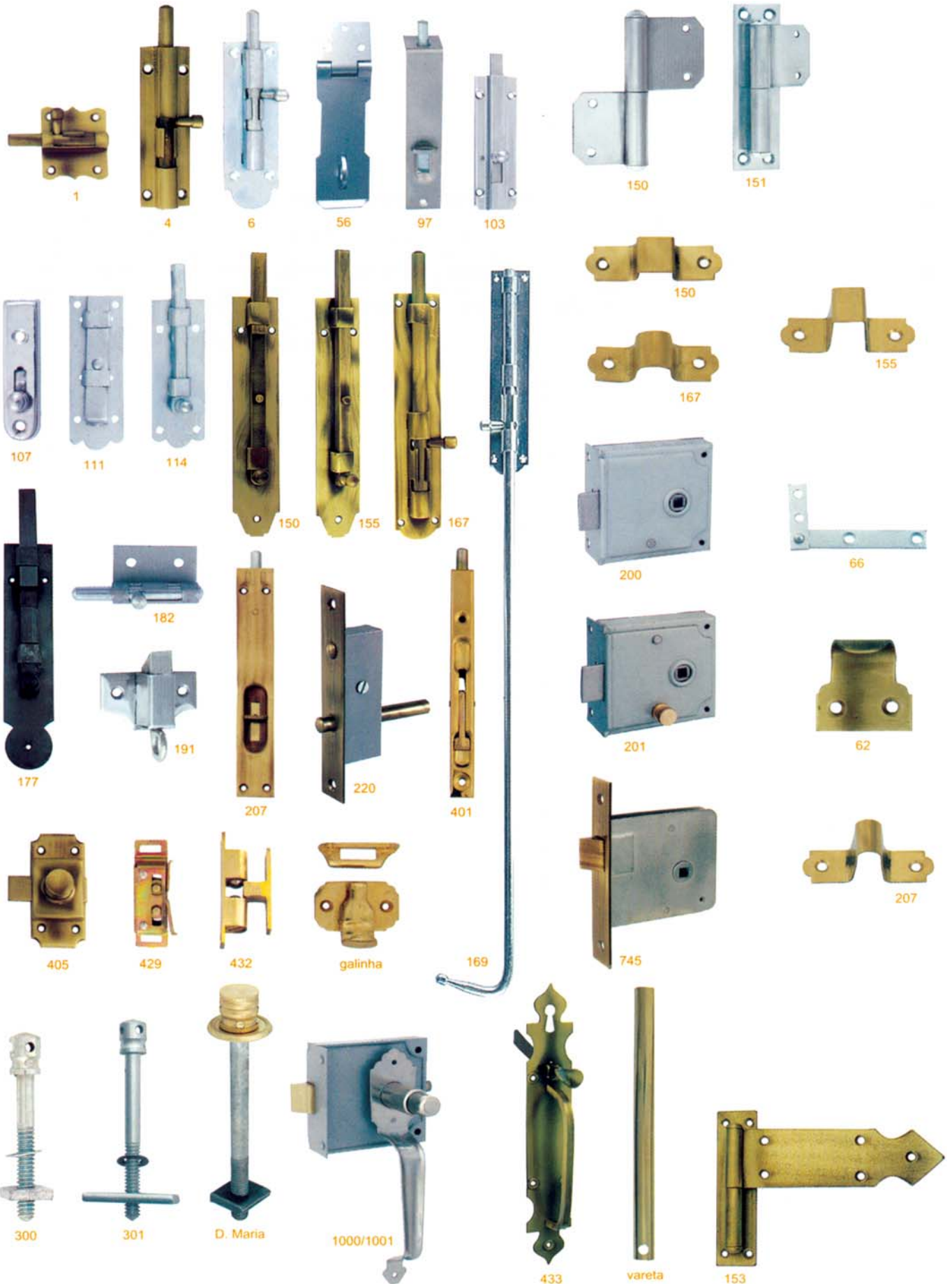
Fechaduras e fechos

Diversos

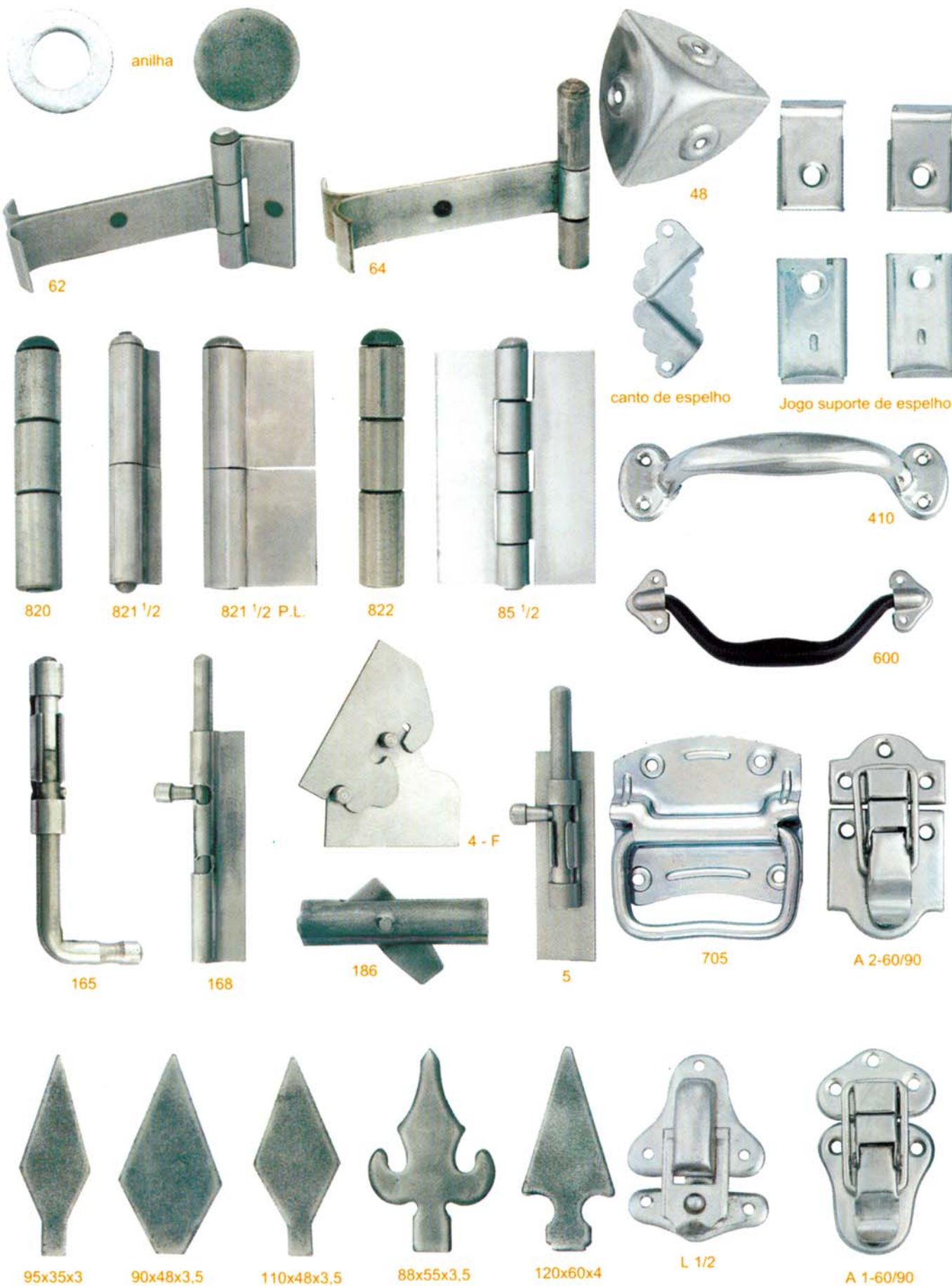

Barras anti-pânico e sinalética

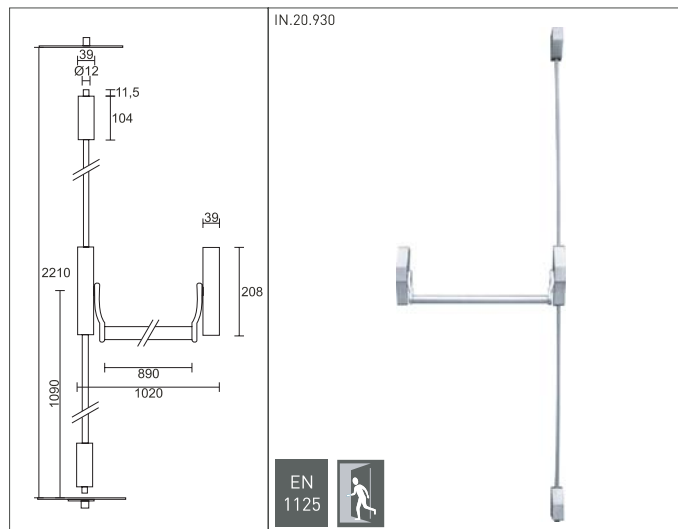

EN
1125

Fechaduras Anti-Pânico Certificadas segundo a Norma Europeia EN1125.
Materiais de Fabrico : Caixas Ext., Barras e Tubo Transversal fabricados em Aço Inox AISI 304.
Acabamento Escovado. Mecanismos Internos em Aço Galvanizado.

Antipanic Locks for Exit Doors Certified Accordingly to the European Norm EN1125.
The Covers, External Bars and Arms are made in Stainless Steel AISI 304. Satin Finish.
The Internal Mechanism It's made in Galvanized Steel.

Cerraduras Antipánico Certificadas Segundo la Norma Europea EN1125.
Las Cajas Ext., Brazos y Barras son Fabricados en Acero Inox AISI 304.
Acabado Satinado.
Los Mecanismos Interiores son Fabricados en Acero Galvanizado.

Barra Anti-Pânico para porta de 2 Folhas.
Instalação na Folha Passiva.
Fecho através de Trinco Superior e Inferior.
Deve ser instalada conjuntamente com as Barras Ref. IN.20.910/911/912.
Funcionamentos possíveis através do exterior são determinados pela Fechadura da Folha Activa.

Antipanic Lock for Double Doors.
Installation at the Secondary Door.
Closing System trough Top and Down Bolts.
This lock must be installed with the Lock Ref.IN.20.910/911/912.
The External function will be determined for the Main Door Function.

Cerradura Antipánico para Puertas de 2 Hojas.
Cierre por Picaporte Alto y Bajo.
Cerradura para la Puerta Passiva.
Esta cerradura se debe instalar con la cerradura Ref. IN.20.910/911/912.
El funcionamiento exterior es determinado por la Cerradura de la Puerta Activa

AISI 304



Pictogramas com fixação por parafusos
Pictograms with fixing system trough screws
Sinalética con sujecion por tornillos

IN.26. _ _ _ S



Pictogramas com suporte para parede
Pictograms with suport wall mounting
Sinalética con soporte a pared

IN.26. _ _ _ A



Pictogramas com fixação por adesivo extra-forte
Pictograms with adhesif fixing
Sinalética con sujecion por adhesivo extra-fuerte

AISI 304

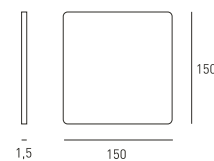

Exemplo de utilização das ferragens para módulos sanitários.
Application example of the sanitary hardware.
Ejemplo de application de las herajas para cabinas sanitárias.

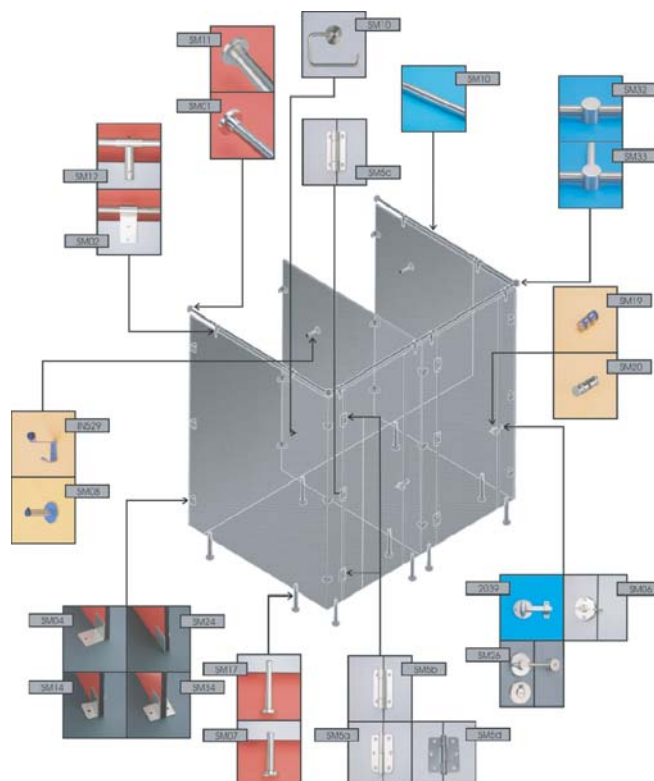

Dobradiças

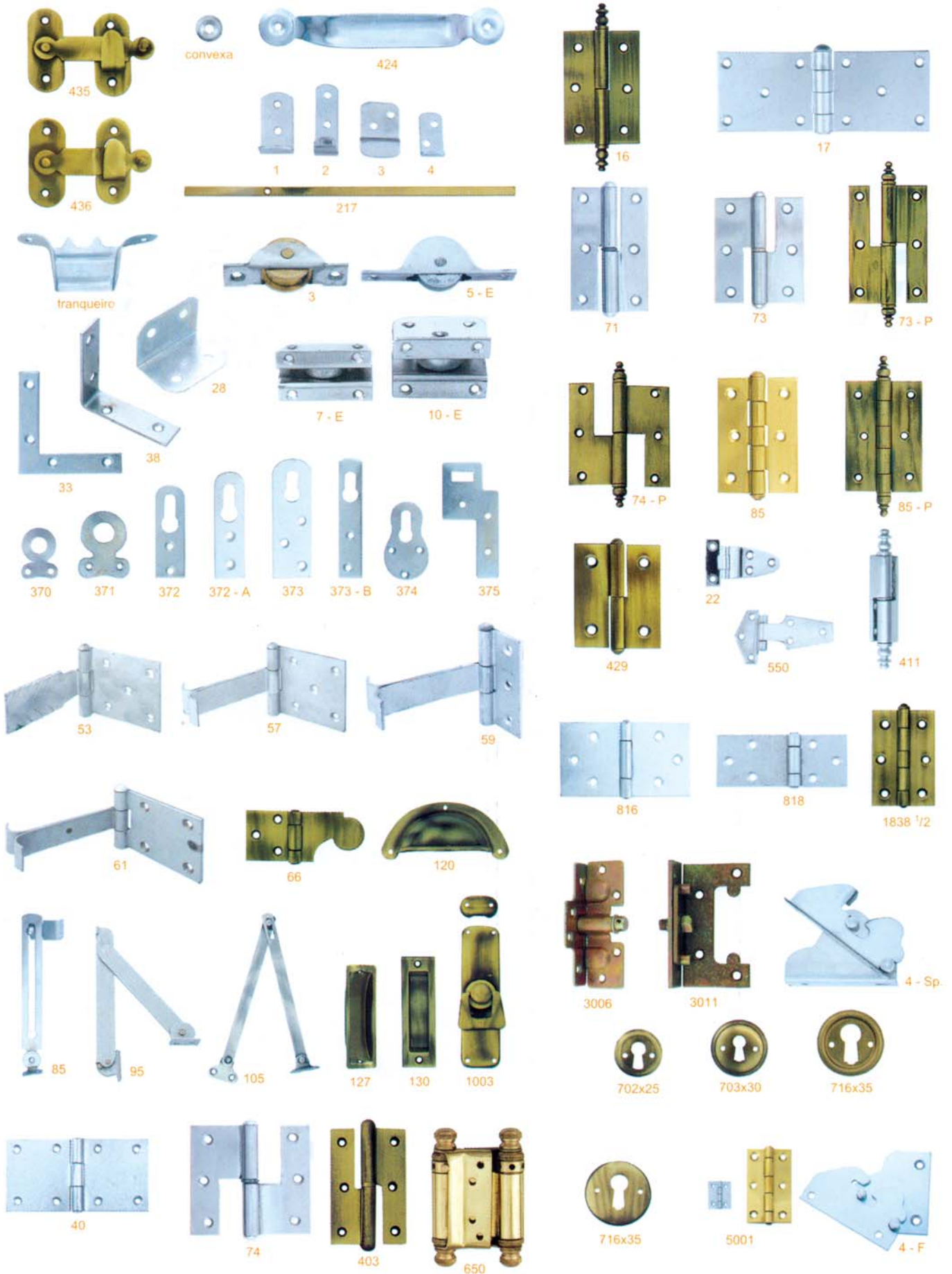

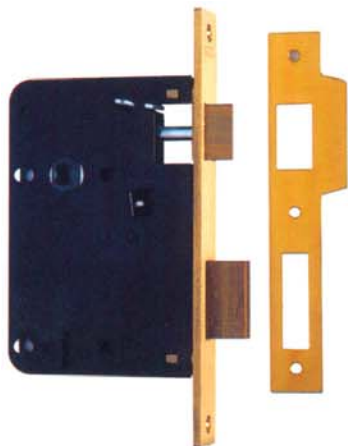
Fechaduras

s/10 - frente rectangular
s/10 - rectangular front

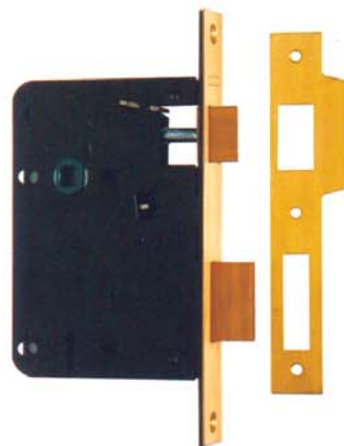

s/11 - frente rectangular
s/11 - rectangular front

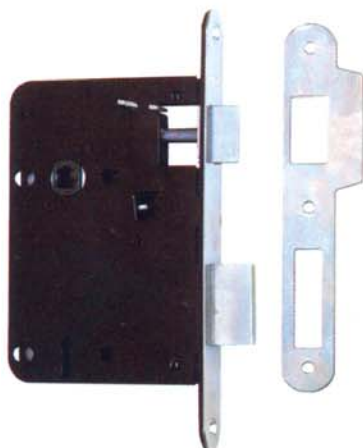

s/11 - frente cantos redondos
s/11 - round corners

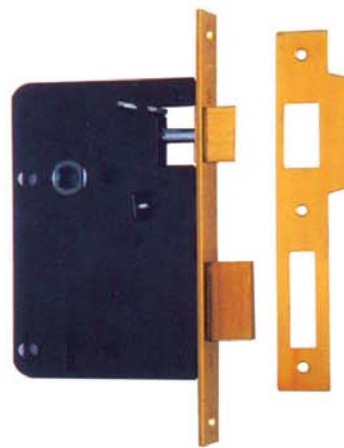

s/12 - frente rectangular
s/12 - rectangular front

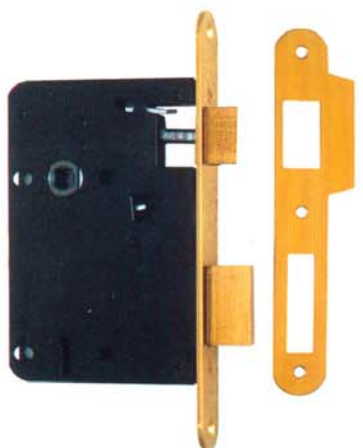

s/12 - frente cantos redondos
s/12 - round corners



s/12 wc - frente rectangular
s/12 wc - rectangular front

Fechaduras Yale e Puxadores



Fechaduras

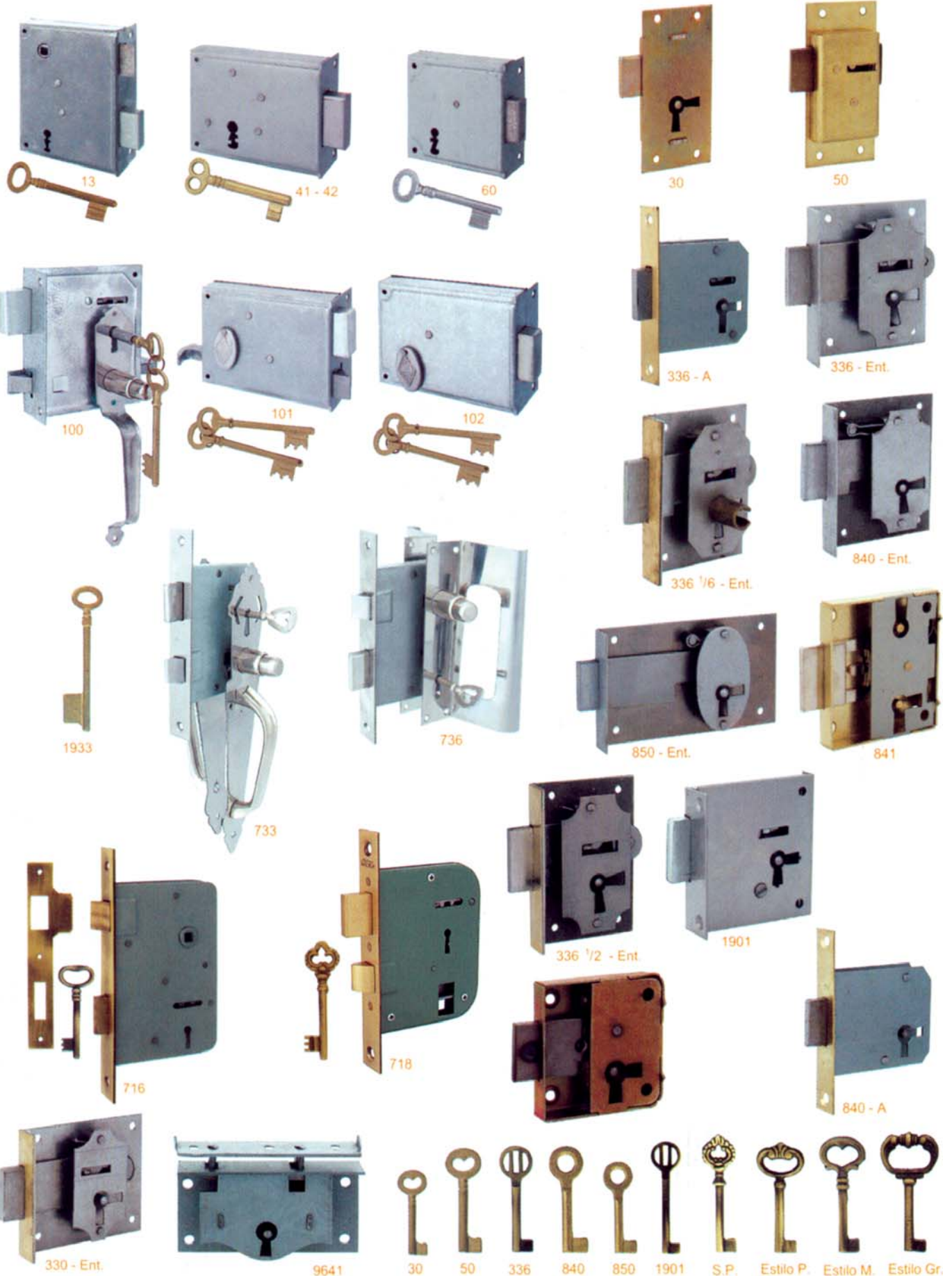

Fechaduras



fechadura s/60
s/60 lock



fechadura s/40 e s/41
s/40 and s/41 lock

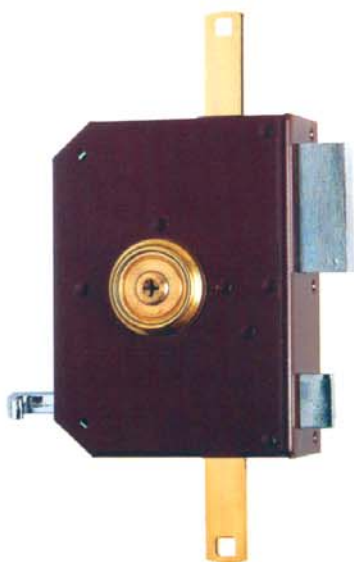

fechadura s/90 duas trancas
s/90 lock two bars

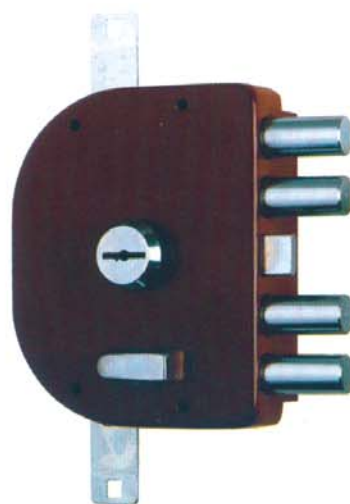

fechadura s/82 duas trancas
s/82 lock two bars

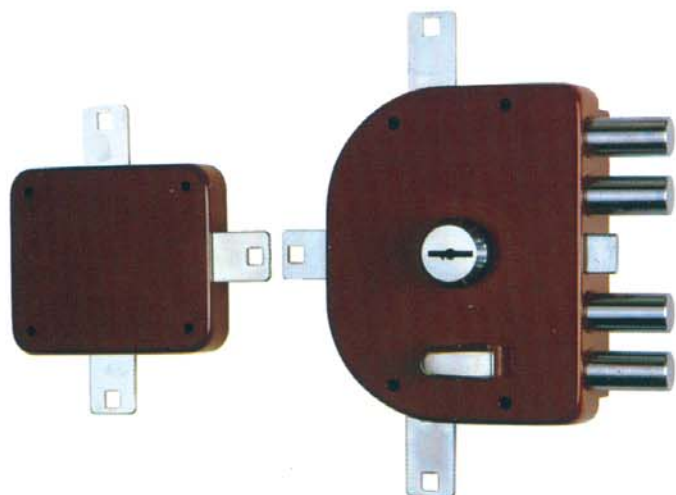

fechadura s/82 quatro trancas
s/90 lock four bars

Fechaduras

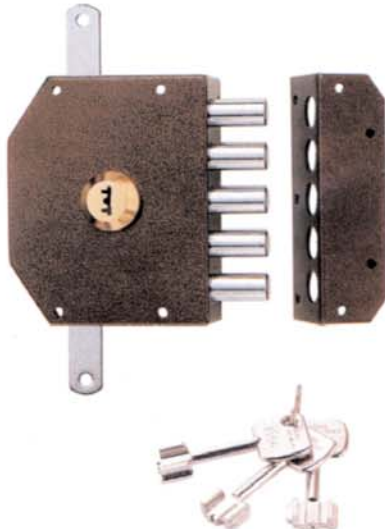

		Artículo			
Latonada	Mano Derecha	913	001 DF	1	-
	Mano Izquierda	913	001 IF	1	-
Barnizada	Mano Derecha	913	005 DF	1	-
	Mano Izquierda	913	005 IF	1	-
Bajo petición: Cilindro de 40 mm.		***	*** **	•40	1 -
Bajo petición: Cilindro de 60 mm.		***	*** **	•60	1 -
Bajo petición: Pomo interior en lugar de bocallave		***	*1*	**	1 -

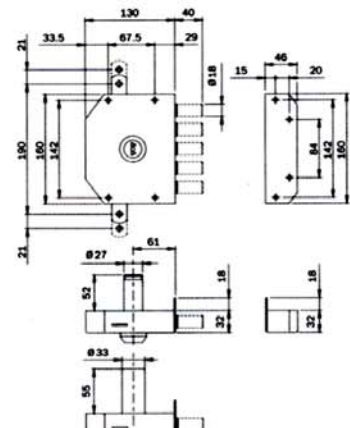
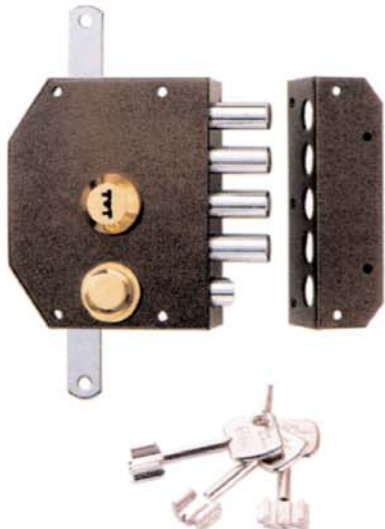
Latonada	Mano Derecha	913	101 DF	1	-
	Mano Izquierda	913	101 IF	1	-
Barnizada	Mano Derecha	913	105 DF	1	-
	Mano Izquierda	913	105 IF	1	-
Bajo petición: Cilindro de 40 mm.		***	*** **	•40	1 -
Bajo petición: Cilindro de 60 mm.		***	*** **	•60	1 -
Bajo petición: Pomo interior en lugar de bocallave		***	*1*	**	1 -

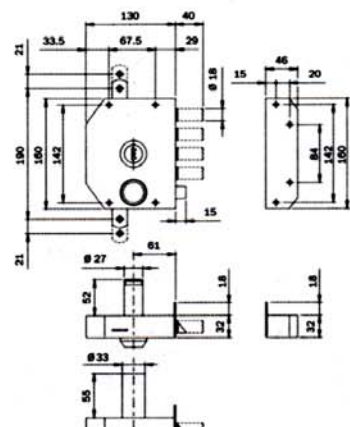

- cerradero
- tornillos de fijación

Fechaduras

Ref.2560/S Fechadura de segurança com três pontos de fecho



Fechadura de segurança com 3 pontos de fecho frontais.

Com possibilidade de instalação de fechos verticais superiores e inferiores (ref.1500 CV).

Fecho por trancas redondas em todas as caixas.

Acabamentos: Frente de alumínio anodizado dourado com os restantes acessórios em latão satinado, ou frente em alumínio anodizado natural com os restantes acessórios em latão cromado .

Acessórios fornecidos:

- Cilindro de segurança ref.2010 SN 66 mm com 5 chaves de pontos.
- Escudo protector do cilindro ref.2002
- Chapa testa a toda a altura da porta na ref.2560 CL
- Três chapa testas separados na ref.2560 S.

Largura da frente: 22 mm

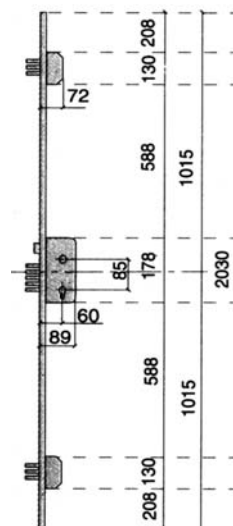

Fechaduras

Ref.2518/CL/5 Fechadura de segurança com cinco pontos de fecho

Fechadura de segurança com 5 pontos de fecho frontais.

Com possibilidade de instalação de fechos verticais superiores e inferiores (ref.1500 CV).

Fecho por língua na caixa central e por trancas redondas nas caixas superiores e inferiores.

Acabamentos: Frente de alumínio anodizado dourado com os restantes acessórios em latão satinado, ou frente em alumínio anodizado natural com os restantes acessórios em latão cromado .

Acessórios fornecidos:

- Cilindro de segurança ref.2010 SN 66 mm com 5 chaves de pontos.
- Escudo protector do cilindro ref.2002
- Chapa testa a toda a altura da porta .

Largura da frente: 20 mm

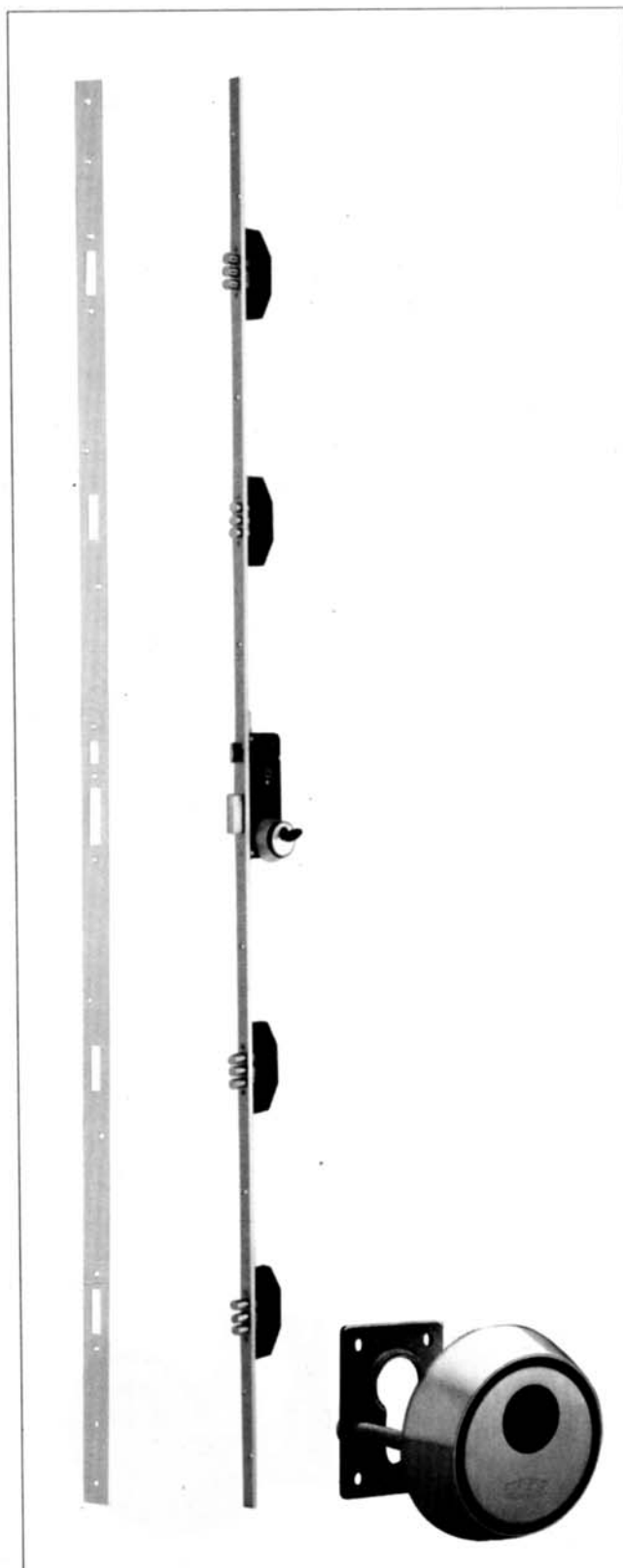
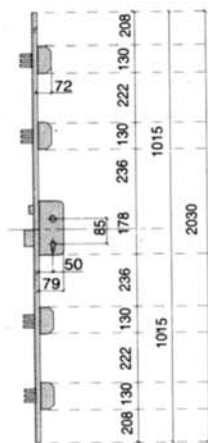

Fechaduras

Ref.2060/T Fechadura de segurança de embutir com um ponto de fecho

Fechadura de embutir de segurança, com um ponto frontal de fecho.
 Frente e testa em latão satinado.
 Fornecida com cilindro ref.2010 SN com cinco chaves de pontos.
 Escudo protector de cilindro ref.2001
 Com 2 voltas.

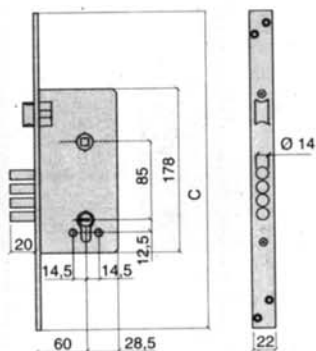

Ref.2060/U Fechadura de segurança de embutir com um ponto de fecho

Fechadura de embutir de segurança, com um ponto frontal de fecho.
 Frente e testa em latão satinado.
 Fornecida com cilindro ref.2010 SN com cinco chaves de pontos.
 Escudo protector de cilindro ref.2004
 Com 2 voltas.

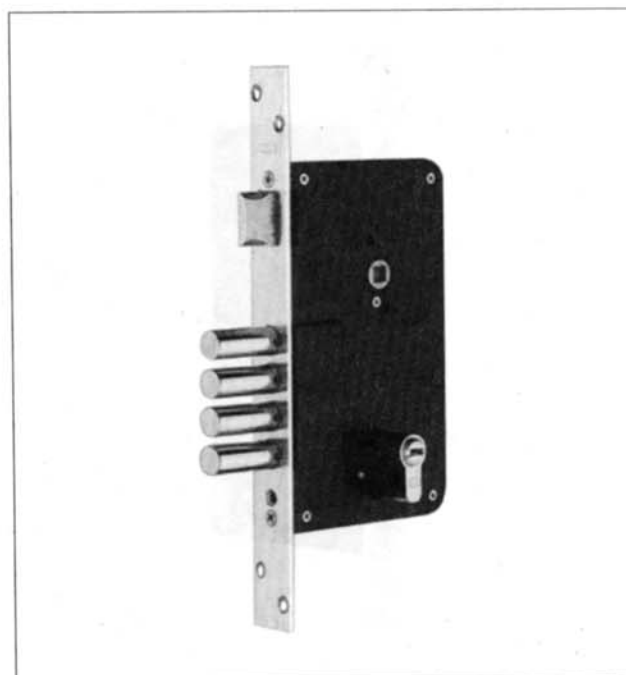
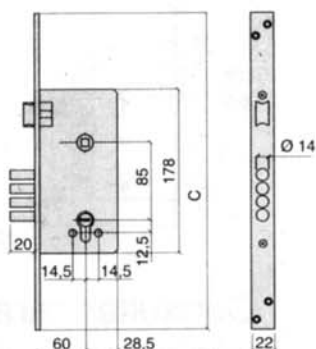

Serie TLB



TLB3

T2B3

TLBF

TLB5

Características

- » Bulones redondos de acero niquelado de Ø14mm en la caja principal.
- » Bulones planos de acero niquelado Ø14mm (ancho 10mm) en cajas auxiliares.
- » Mecanismos protegidos en cajas cerradas de acero galvanizado.
- » Puntos de cierre alto y bajo (acero carbonitrurado).
- » Cerradero alto de acero y cerradero de suelo con guardapolvos.
- » Frente de acero de perfil en U de elevada rigidez, idóneo para puertas **RF**.
- » Mecanismo en los reenvíos con sistema anti-retorno.
- » Cerraderos largos de ancho estándar de 40mm y opcional en 35 y 45mm. Altura estándar de 2.028mm y opcional para alturas de 2.035 mm.
- » Frente de la cerradura estándar de 20x10 mm. Opcional en modelos **TLB3**, **T2B3**, **TLB5** y **T2B5** posibilidad de frente de 20 x 7,5mm.
- » Posibilidad de frente y cerradero de longitud 2.110mm.
- » Posibilidad de incorporar embellecedor de escudo guarda-llaves.

TLB3 / T2B3 / TLBF

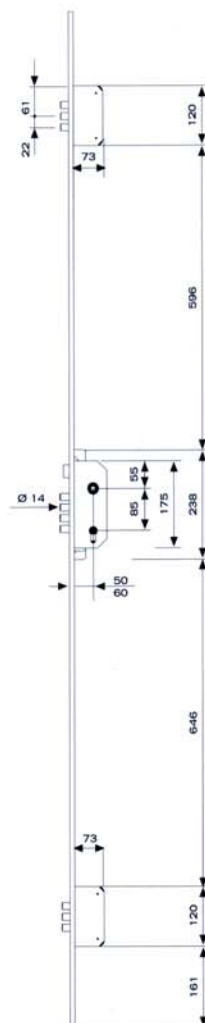

TLB5

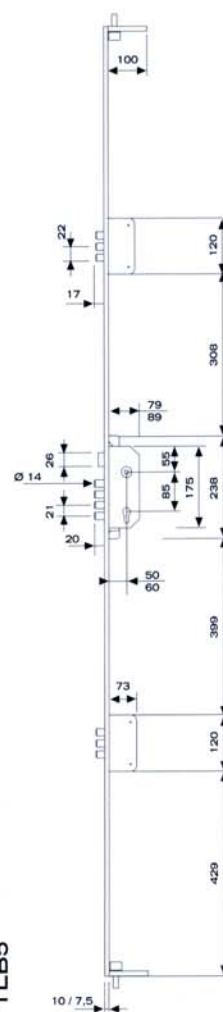

Barras anti-pânico

1910



Dispositivo de sobreponer con un punto lateral de cierre. Picaporte de acero, basculante. Accionamiento exterior. Consultar tabla de la página 12 / VE. Certificación EN 1125:

3 7 6 1 1 3 2 2 A

El embalaje incluye:

- » 1 soporte principal y otro secundario.
- » 1 barra horizontal ovalada de 900 mm.
- » 1 bolsa de accesorios con cerradero, cuadradillo y tornillos de sujeción.
- » hojas de instrucciones y plantilla de instalación.

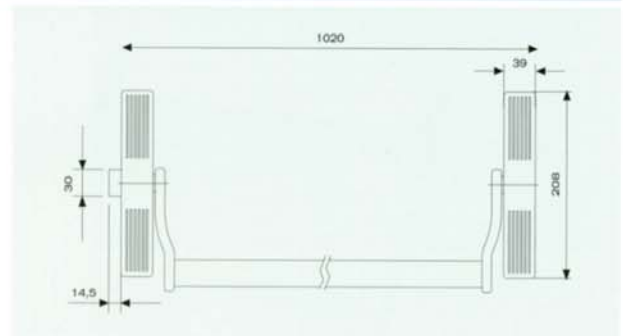

1920



Dispositivo de sobreponer con dos puntos de cierre de bulón. Se utiliza cuando no se puede instalar un cerradero de sobreponer en el punto inferior de cierre. Certificación EN 1125:

3 7 6 1 1 3 2 2 A

Funcionamiento:

Accionando el dispositivo antipánico, los bulones salen de su alojamiento y quedan retenidos. Al cerrarse la puerta, una pieza móvil del retenedor de falleba golpea el marco liberando el movimiento de las fallebas que se vuelven a introducir en los cerraderos.

Altura estandar: 2210mm. Accionamiento exterior. Consultar tabla de la página 12 / VE. (Solución con cilindro sólo disponible con manilla modular).

El embalaje incluye:

- » 1 soporte principal y otro secundario.
- » 1 barra horizontal ovalada de 900 mm.
- » 2 fallebas de 930 mm.
- » 1 bolsa de accesorios con: cerradero, retenedor de falleba, guardapolvo, cuadradillo y tornillos de sujeción.
- » hojas de instrucciones y plantilla de instalación.
- » 2 reenvíos para los puntos de cierre altos y bajos.

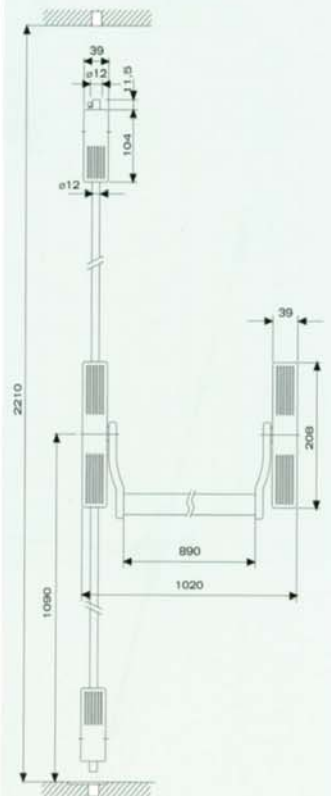

Barras anti-pânico

1930



Dispositivo de sobreponer con dos puntos, alto y bajo, de cierre. Picaportes de acero, basculantes.

Altura estándar: 2210mm. Accionamiento exterior. Consultar tabla de la página 12 / VE. Certificación EN 1125:

3 7 6 1 1 3 2 2 A

El embalaje incluye:

- » 1 soporte principal y otro secundario.
- » 1 barra horizontal ovalada de 900 mm.
- » 2 fallebas de 930 mm.
- » 1 bolsa de accesorios con cerraderos -alto y bajo-, cuadradillo, tornillos de sujeción y dos guías de falleba.
- » hojas de instrucciones y plantilla de instalación.
- » 2 reenvíos para los puntos de cierre altos y bajos.

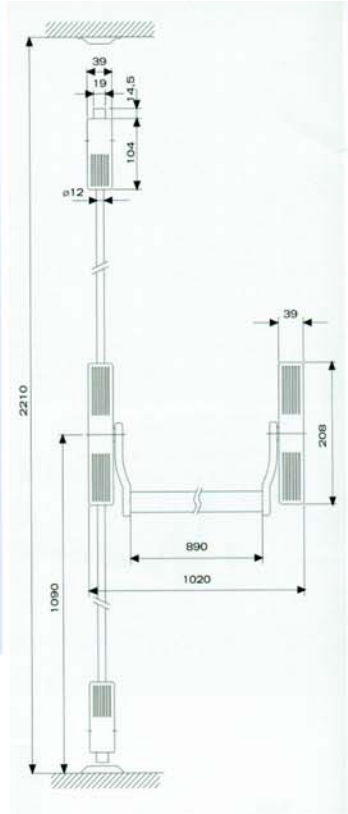

1950



Dispositivo de sobreponer con tres puntos, alto, bajo y central -lateral-, de cierre. Picaportes de acero, basculantes.

Altura estándar: 2210mm. Accionamiento exterior. Consultar tabla de la página 12 / VE. Certificación EN 1125:

3 7 6 1 1 3 2 2 A

El embalaje incluye:

- » 1 soporte principal y otro secundario.
- » 1 barra horizontal ovalada de 900 mm.
- » 2 fallebas de 930 mm.
- » 1 bolsa de accesorios con cerraderos -alto, central y bajo- cuadradillo, tornillos de sujeción y dos guías de falleba.
- » Hojas de instrucciones y plantilla de instalación.
- » 2 reenvíos para los puntos de cierre altos y bajos.

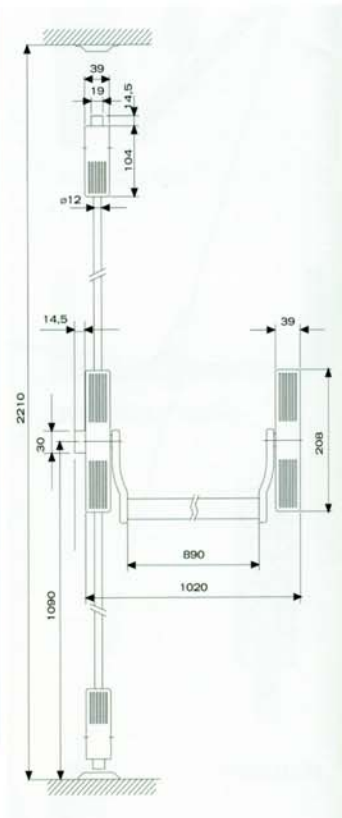

Portas de segurança

Máxima Segurança

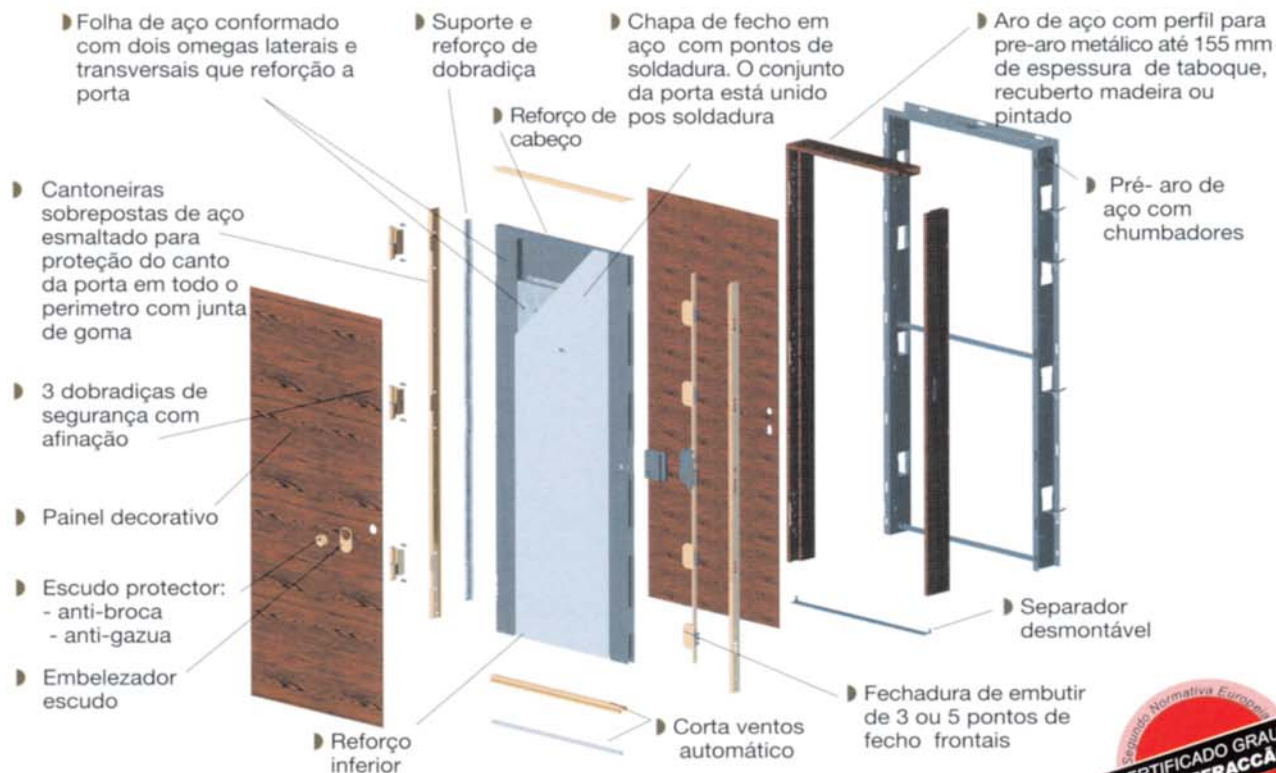

Trinco regulável



cantoneira e reforço de dobradiça



Aro e grosso de taboquete



Junta de goma que proporciona isolamento termo-acústico

Cilindro de obra TE5 com chaves iguais
Cilindro de segurança T80 ó TX80

Características:

- Certificado com grau 3 anti-efracção segundo a normativa europeia ENV 1630
- Aro revestido com o mesmo acabamento da folha, madeira, pintado.
- Possibilidade de instalar pré-aro metálico ou de madeira
- Possibilidade de utilizar fechadura multipontos de alta segurança.
- Cortaventos automático ou taco em madeira opcional.

Modelo	A	B	C	D	E	Altura
775	75/100 /120 /140 / 155	23,5	741	835	905	2030
837	75/100 /120 /140 / 155	23,5	803	897	967	2110
925	75/100 /120 /140 / 155	23,5	891	985	1055	

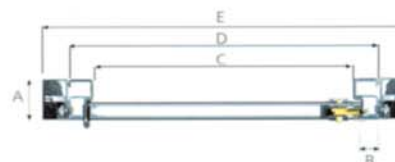

Portas de correr

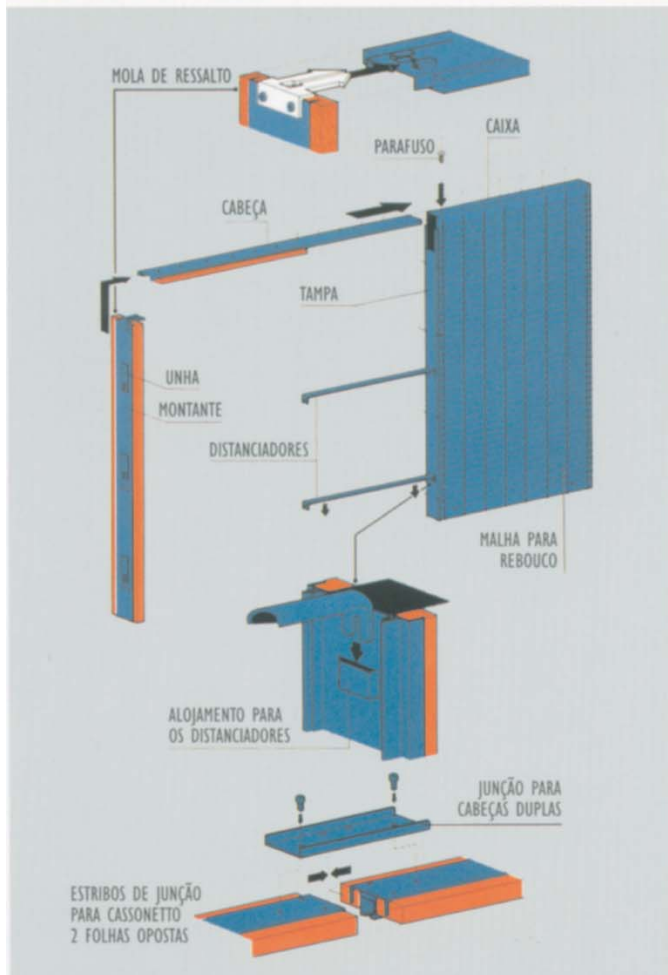
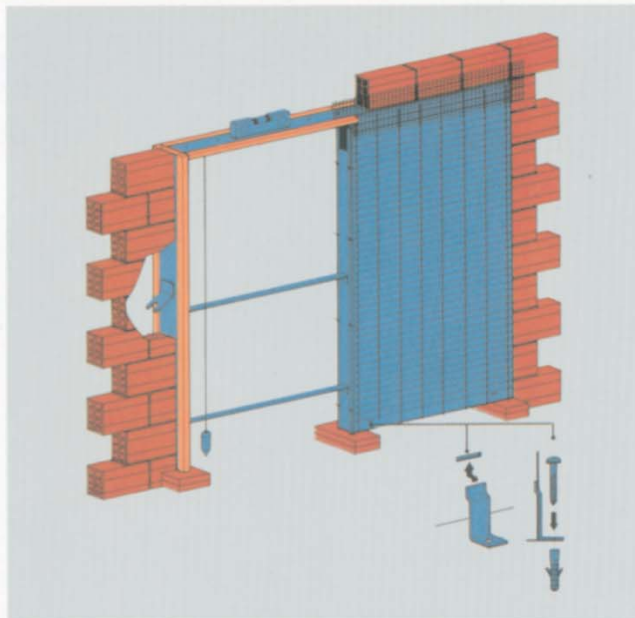
CASSONETTO UNICO
MONTAGEM DA ESTRUTURA

CASSONETTO UNICO
MONTAGEM EM REBOCO

O CASSONETTO ENCONTRA-SE DISPONÍVEL
 NAS VERSÕES PARA PAREDE / INTERIOR:
 90 / 59 - 105 / 74 - 125 / 84

1 FOLHA				2 FOLHAS			
A	B	C	D	A	B	C	D
2000 2100	600	2073 2173	1285	2000 2100	1200	2073 2173	2472
2000 2100	700	2073 2173	1485	2000 2100	1400	2073 2173	2872
2000 2100	800	2073 2173	1685	2000 2100	1600	2073 2173	3272
2000 2100	900	2073 2173	1885	2000 2100	1800	2073 2173	3672
2000 2100	1000	2073 2173	2085	2000 2100	2000	2073 2173	4072
2000 2100	1100	2073 2173	2285	2000 2100	2200	2073 2173	4472
2000 2100	1200	2073 2173	2485	2000 2100	2400	2073 2173	4872

A - Abertura visível na altura C - Altura máxima ocupada pelo Cassonetto
 B - Abertura visível na largura D - Largura máxima ocupada pelo Cassonetto

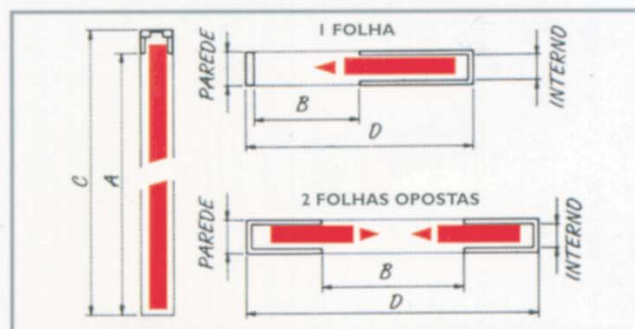
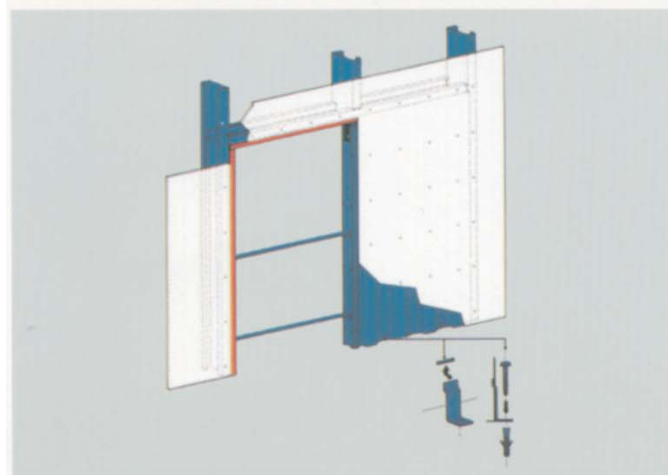
Nota: Todas as dimensões em (mm)

CASSONETTO UNICO
MONTAGEM COM "Pladur"

O CASSONETTO ENCONTRA-SE
 DISPONÍVEL NAS VERSÕES PARA
 PAREDE / INTERIOR:
 100 / 59 - 125 / 84

Fechaduras

Ref.2065/S Fechadura de segurança de embutir com um ponto de fecho



Fechadura de embutir de segurança, com um ponto frontal de fecho.
Frente e testa em latão satinado.
Fornecida com cilindro ref.2010 SN com cinco chaves de pontos.
Escudo protector de cilindro ref.2002.
Com 4 voltas.

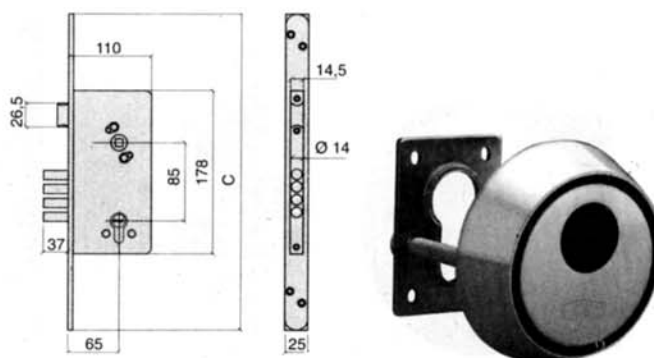

Ref.5260 AN Fechadura para HOTEL anti-pânico



Fechadura de embutir com trinco silencioso.
Possui sistema de bloqueio ao trinco.
Com mecanismo anti-pânico.
Pode ser equipada com qualquer cilindro de perfil europeu.
Frente em latão satinado ou cromada.
Fechadura direita ou esquerda.

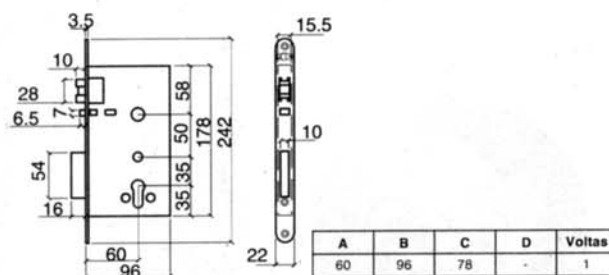

Fechaduras

Ref.4125/N Fechadura de segurança de sobrepôr

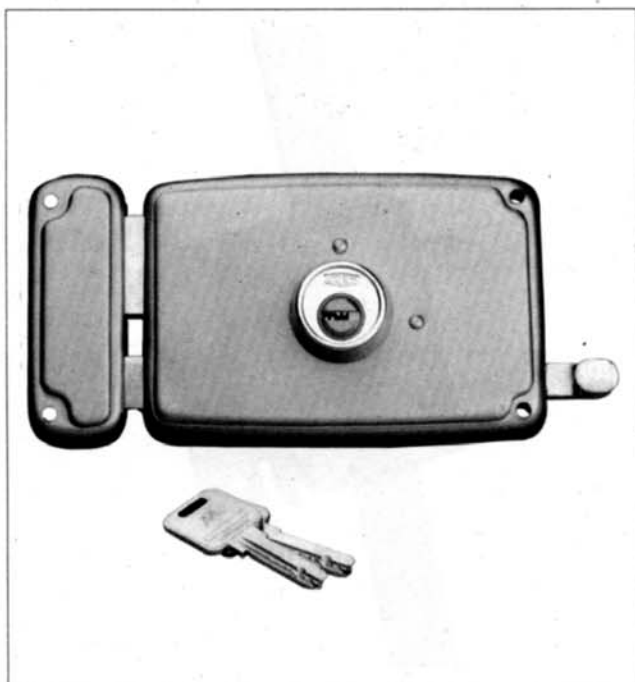

Fechadura de segurança com cilindro de chave de pontos.
Com cilindro por ambos os lados.
Fornecida com 5 chaves.
Permite mestragem UCEM com cilindros da série 2000.

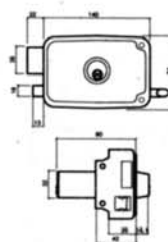

A	B	C	D	Volts
-	140	94	24	2

Ref.4100/S Ferrolho de segurança



Ferrolho de segurança com cilindro de chave de pontos.
Com botão pelo interior e cilindro pelo exterior.
Permite sistema de mestragem UCEM.
Fornecido com 5 chaves de pontos, escudo protector, cadeado de segurança.

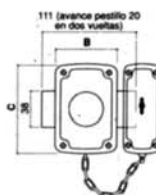

A	B	C	D	Volts
-	65	95	20	2

Fechaduras

Serie TS30 / TS50



TS30

TS50

- » Cerraderos laterales conformando una caja cerrada de acero reforzado que impide el apalancamiento.
- » Puntos de anclaje alto y bajo, en acero carbonitrurado. Se incluyen los cerraderos superior e inferior, de acero reforzado. Cerradero inferior con placa guardapolvos.
- » Fallebas de conexión entre puntos de cierre ocultas bajo cubre-barras.
- » Escudo de seguridad **ESTS** antitaladro y antimordaza.
- » El cilindro estándar permite la instalación en puertas de hasta 48mm de anchura.
- » Para espesores de puerta superiores, existen a su disposición cilindros con lengüeta regulable, que cubren hasta 80mm de espesor de puerta.
- » Picaporte accionable con llave desde el exterior y con tirador desde el interior.
- » Acabado de cajas y cubrebarras en acero esmaltado oro y acero cromado.
- » Acabado del escudo **ESTS** en acero esmaltado oro y acero cromado.

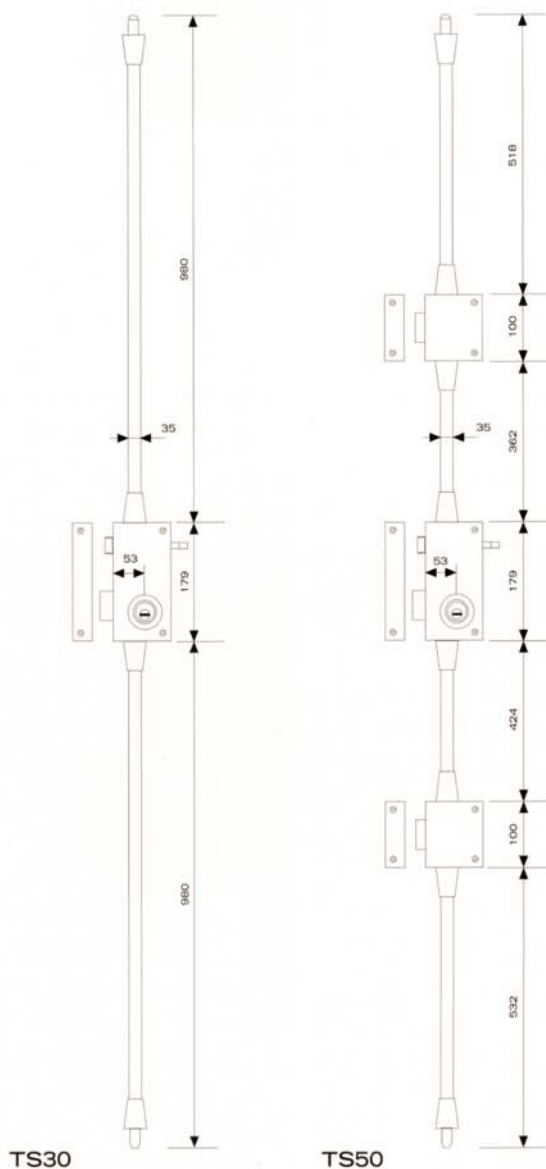

TS30

TS50

Fechaduras
Ref.4510/S Fechadura de segurança com trancas

Fechadura de segurança com trancas.
 Cilindro de chave de pontos.
 Sistema que impede abertura por alavanca.
 Permite sistema de mestragem UCEM com os cilindros da série 2000.
 Indicada para portas de uma ou duas folhas.
 Fornecida com 5 chaves de pontos, escudo protector com ajuste automático à espessura da porta, cadeado de segurança, protectores de dobradiças.

Embalagem transparente.

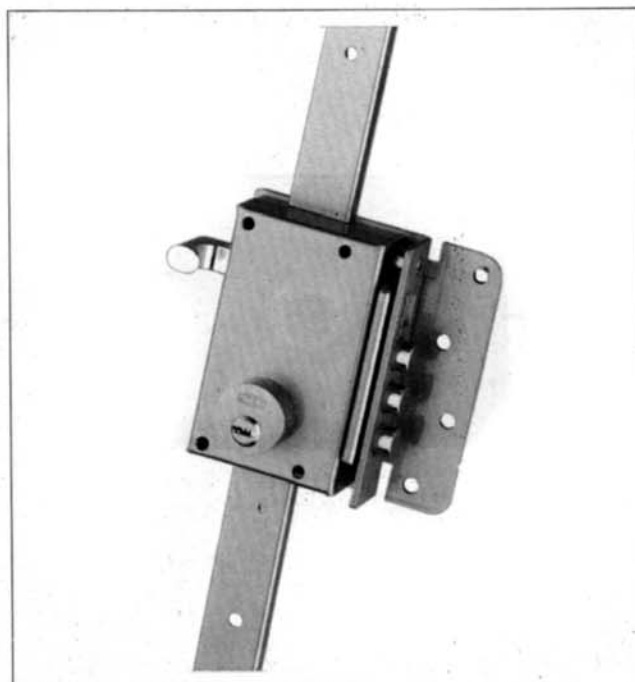
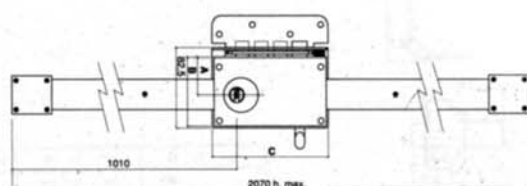

Ref.4516/SA Fechadura de segurança com trancas

Fechadura de segurança com trancas.
 Cilindro de chave de pontos.
 Sistema que impede abertura por alavanca.
 Permite sistema de mestragem UCEM com os cilindros da série 2000.
 Indicada para portas de uma ou duas folhas.
 Fornecida com 5 chaves de pontos, escudo protector com ajuste automático à espessura da porta, cadeado de segurança, protectores de dobradiças.

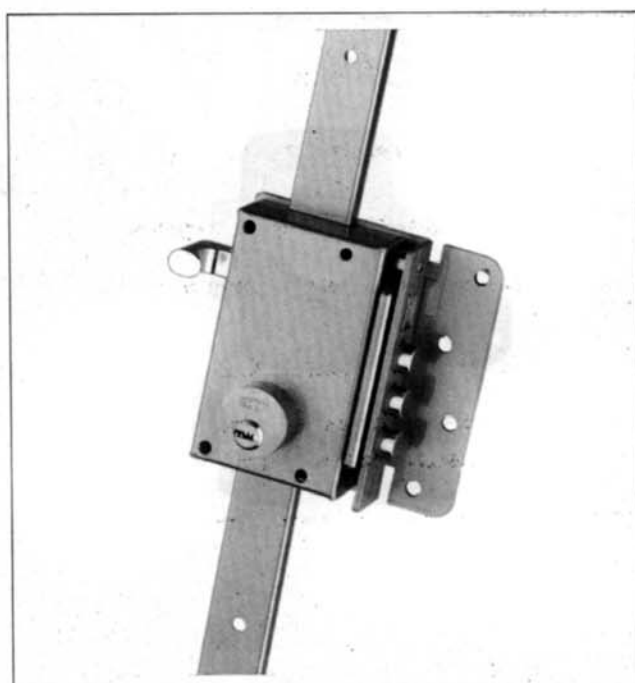
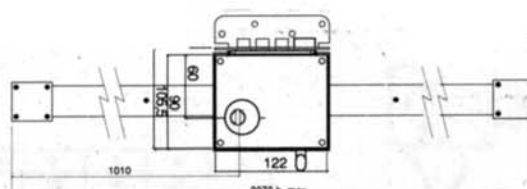
Embalagem transparente.

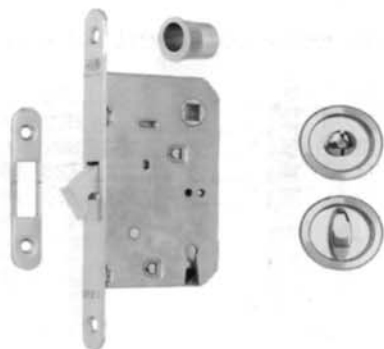

Fechaduras



Kit A - pomo/botón, espesor de puerta 38-48 mm

ACERO + LATÓN				
Entrada 50	Bronceado	B01914.50.02	1	1
	Latonado Barn.	B01914.50.03	1	1
	Cromado Opaco	B01914.50.34	1	1
LATÓN				
Entrada 50	Latón Satinado	B01915.50.08	☎	1
	Pulido Barn.	B01915.50.10	1	1
	Cromado	B01915.50.30	1	1
	Cromado Satinado	B01915.50.32	1	1



Kit B - pomo/pomo, espesor puerta 38-48 mm

ACERO + LATÓN				
Entrada 50	Bronceado	B01918.50.02	1	1
	Latonado Barn.	B01918.50.03	1	1
	Cromado Opaco	B01918.50.34	1	1
LATÓN				
Entrada 50	Latón Satinado	B01919.50.08	☎	1
	Pulido Barn.	B01919.50.10	1	1
	Cromado	B01919.50.30	1	1
	Cromado Satinado	B01919.50.32	1	1

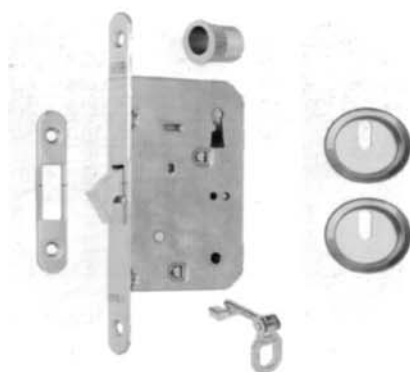

Kit M - espesor puerta 38-48 mm

ACERO + LATÓN				
Entrada 50	Bronceado	B01921.50.02	1	1
	Latonado Barn.	B01921.50.03	1	1
	Cromado Opaco	B01921.50.34	1	1
LATÓN				
Entrada 50	Latón Satinado	B01922.50.08	☎	1
	Pulido Barn.	B01922.50.10	1	1
	Cromado	B01922.50.30	1	1
	Cromado Satinado	B01922.50.32	1	1

Fechaduras

Kit C - bulón/botón, espesor puerta 38-47 mm

ACERO + LATÓN				
Entrada 50	Bronceado	B01904.50.02	1	1
	Latonado Barn.	B01904.50.03	1	1
	Cromado Opaco	B01904.50.34	1	1
LATÓN				
Entrada 50	Latón Satinado	B01905.50.08	1	1
	Pulido Barn.	B01905.50.10	1	1
	Cromado	B01905.50.30	1	1
	Cromado Satinado	B01905.50.32	1	1

Kit D - bulón/bulón con llave, espesor puerta 38-47 mm

ACERO + LATÓN				
Entrada 50	Bronceado	B01906.50.02	1	1
	Latonado Barn.	B01906.50.03	1	1
	Cromado Opaco	B01906.50.34	1	1
LATÓN				
Entrada 50	Pulido Barn.	B01907.50.10	1	1
	Cromado	B01907.50.30	1	1
	Cromado Satinado	B01907.50.32	1	1

Kit N - espesor puerta 38-47 mm

ACERO + LATÓN				
Entrada 50	Bronceado	B01928.50.02	1	1
	Latonado Barn.	B01928.50.03	1	1
	Cromado Opaco	B01928.50.34	1	1
LATÓN				
Entrada 50	Latón Satinado	B01929.50.08	1	1
	Pulido Barn.	B01929.50.10	1	1
	Cromado	B01929.50.30	1	1
	Cromado Satinado	B01929.50.32	1	1

Fechaduras



**Fechadura eléctrica icsa
s/ botão chave-chave**

Ref. ^o	CX
2170	1

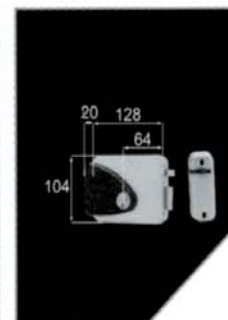

**Fechadura eléctrica icsa
c/ botão chave-chave-botão**

Ref. ^o	CX
2770	1

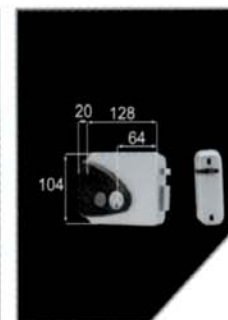

**Fechadura eléctrica icsa
chave-botão**

Ref. ^o	CX
2772	1

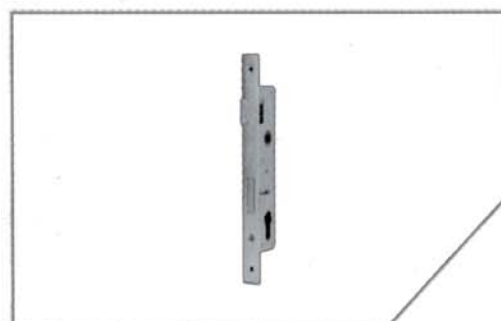
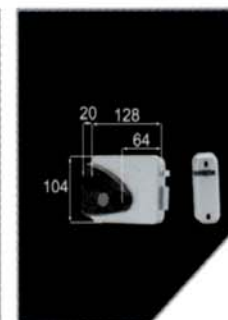

**Fechadura p/ porta
de embutir p/ alumínio**

Ref. ^o	Entrada	CX
102.85	20 / 25 / 30	10

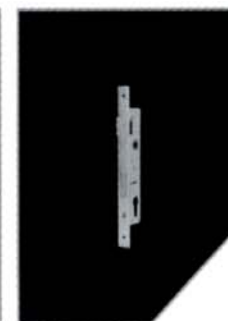

**Fechadura gancho
c/ perno segurança**

Ref. ^o	CX
555/60	1

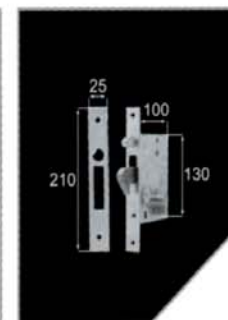

Dobradiças

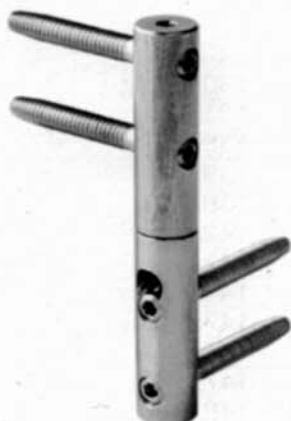
Zenit

ACERO					
ø 16	Bicromatado	145	E02150.16.04	12	120
	Zincado Plata	145	E02150.16.15	12	120
ø 20	Bicromatado	145	E02150.20.04	12	120
	Zincado Plata	145	E02150.20.15	12	120

Zenit - Antivandalismo

ACERO					
ø 20	Bicromatado	145	E02153.20.04	12	120
	Zincado Plata	145	E02153.20.15	☎	12 120

Top

ACERO					
ø 16	Bronceado	99	E00150.16.02	☎	12 120
	Bicromatado	99	E00150.16.04	12	120
	Zincado Plata	99	E00150.16.15	☎	12 120
ø 20	Bicromatado	111	E00150.20.04	12	60
	Zincado Plata	111	E00150.20.15	☎	12 60

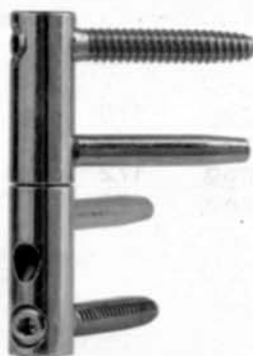
3D

ACERO					
ø 14	Bronceado	82	E01150.14.02	12	120
	Bicromatado	82	E01150.14.04	12	120
	Zincado Plata	82	E01150.14.15	12	120
ø 16	Bronceado	82	E01150.16.02	☎	12 120
	Bicromatado	82	E01150.16.04	12	120
	Bicromatado	82*	● E01160.16.04	☎	12 120
	Zincado Plata	82	E01150.16.15	12	120

*Aguja de 65 mm

ACERO INOX

ø 14	Natural	82	E01165.14.01	12	120
ø 16	Natural	82	E01165.16.01	12	120

Mod.159 2 agujas

ACERO					
ø 14	Bicromatado	66	E00159.14.04	40	200



Dobradiças



Mod.119

ACERO					
ø 9	Bronceado	37	E00119.09.02	100	1000
	Latonado Barn.	37	E00119.09.03	100	1000
	Bicromatado	37	E00119.09.04	100	1000
	Niquelado	37	E00119.09.06	100	1000
ø 11	Bronceado	40	E00119.11.02	80	800
	Latonado Barn.	40	E00119.11.03	80	800
	Bicromatado	40	E00119.11.04	80	800
	Niquelado	40	E00119.11.06	80	800
	Cromado Opaco	40	E00119.11.34	80	800
ø 13	Natural	45	E00119.13.01	100	400
	Bronceado	45	E00119.13.02	100	400
	Latonado Barn.	45	E00119.13.03	100	400
	Bicromatado	45	E00119.13.04	100	400
	Niquelado	45	E00119.13.06	100	400
	Zincado Plata	45	E00119.13.15	☞	100 400
	Cromado Opaco	45	E00119.13.34	☞	40 400
ø 14	Natural	50	E00119.14.01	100	300
	Bronceado	50	E00119.14.02	100	300
	Latonado Barn.	50	E00119.14.03	100	300
	Bicromatado	50	E00119.14.04	100	300
	Niquelado	50	E00119.14.06	100	300
	Zincado Plata	50	E00119.14.15	☞	100 300
	Cromado Opaco	50	E00119.14.34	☞	40 320
ø 16	Bronceado	54	E00119.16.02	50	200
	Latonado Barn.	54	E00119.16.03	50	200
	Bicromatado	54	E00119.16.04	50	200
	Niquelado	54	E00119.16.06	50	200
	Zincado Plata	54	E00119.16.15	☞	50 200
	Cromado Opaco	54	E00119.16.34	☞	50 200
ø 20	Bronceado	67	E00119.20.02	10	100
	Bicromatado	67	E00119.20.04	10	100
LATÓN					
ø 9	Pulido Barn.	37	E00124.09.10	100	1000
ø 11	Niquelado	40	E00124.11.06	☞	80 400
	Satinado	40	E00124.11.08	☞	80 400
	Pulido Barn.	40	E00124.11.10	80	400
ø 13	Bronceado	45	E00124.13.02	40	400
	Niquelado	45	E00124.13.06	☞	40 400
	Antracita	45	E00124.13.07	☞	40 400
	Satinado	45	E00124.13.08	☞	40 400
	Pulido Barn.	45	E00124.13.10	40	400
ø 14	Bronceado	50	E00124.14.02	40	320
	Niquelado	50	E00124.14.06	☞	40 320
	Antracita	50	E00124.14.07	☞	40 320
	Satinado	50	E00124.14.08	☞	40 320
	Pulido Barn.	50	E00124.14.10	40	320
ø 16	Bronceado	54	E00124.16.02	40	200
	Niquelado	54	E00124.16.06	☞	40 200
	Satinado	54	E00124.16.08	☞	40 200
	Pulido Barn.	54	E00124.16.10	40	200
ACERO INOX					
ø 14	Natural	51	E00125.14.01	40	320
	Satinado	51	E00125.14.08	40	320

Dobradiças



Mod.118

ACERO					
ø 13	Bronceado	45	E00118.13.02	100	400
	Latonado Barn.	45	E00118.13.03	100	400
	Bicromatado	45	E00118.13.04	100	400
	Niquelado	45	E00118.13.06	100	400
	Zincado Plata	45	E00118.13.15	100	400
	Cromado Opaco	45	E00118.13.34	40	320
ø 14	Bronceado	49	E00118.14.02	100	300
	Latonado Barn.	49	E00118.14.03	100	300
	Bicromatado	49	E00118.14.04	100	300
	Niquelado	49	E00118.14.06	100	300
	Zincado Plata	49	E00118.14.15	100	300
	Cromado Opaco	49	E00118.14.34	40	320
ø 16	Bronceado	54	E00118.16.02	50	200
	Latonado Barn.	54	E00118.16.03	50	200
	Bicromatado	54	E00118.16.04	50	200
	Zincado Plata	54	E00118.16.15	50	200
	Cromado Opaco	54	E00118.16.34	50	200



Mod.113

ACERO					
ø 9	Bronceado	25	E00113.09.02	150	1500
	Latonado Barn.	25	E00113.09.03	150	1500
	Bicromatado	25	E00113.09.04	150	1500
	Niquelado	25	E00113.09.06	150	1500
ø 13	Bronceado	36	E00113.13.02	100	400
	Latonado Barn.	36	E00113.13.03	100	400
	Bicromatado	36	E00113.13.04	100	400
ø 14	Niquelado	36	E00113.13.06	100	400
	Bronceado	41	E00113.14.02	100	300
	Latonado Barn.	41	E00113.14.03	100	300
ø 16	Bicromatado	41	E00113.14.04	100	300
	Bronceado	46	E00113.16.02	50	200
	Latonado Barn.	46	E00113.16.03	50	200
	Bicromatado	46	E00113.16.04	50	200
ø 16	Niquelado	46	E00113.16.06	50	200



Mod.116

ACERO					
ø 13	Latonado Barn.	39	E00116.13.03	100	400
	Bicromatado	39	E00116.13.04	100	400
ø 14	Bronceado	46	E00116.14.02	100	300
	Latonado Barn.	46	E00116.14.03	100	300
	Bicromatado	46	E00116.14.04	100	300
ø 16	Bronceado	51	E00116.16.02	50	200
	Latonado Barn.	51	E00116.16.03	50	200
	Bicromatado	51	E00116.16.04	50	200

Sistemas de fecho de portas automático



USO
MODERADO



TS 1000 C



TS 1500



TS 1500 G



USO
FRECUENTE



TS 2000 V



TS 3000 V



USO
INTENSIVO



TS 4000



TS 5000



Boxer

Cierrapuertas oculto para
puertas batientes y vaivén



TS 500 NV / EN3 & TS 550

Cierrapuertas de pavimento

Sistemas de fecho

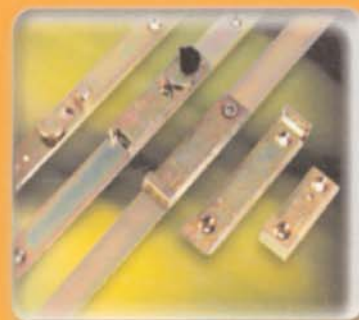
**DSS****Cremona TESI 2000****Accesorios**

COLOCACIÓN Y FIJACIÓN



El DSS es aplicable a la cremona TESI 2000 en la especial posición, mediante tornillos normales para la fijación de los herrajes.



Caja de desplazamiento dotada de casquillos de fijación profundados, para facilitar las elaboraciones más precisas.

AMPLIA GAMA

Disponibles en diferentes tamaños, desde GR 0 hasta GR 10.

NB. Se puede instalar el DSS a partir de la cremona GR2.

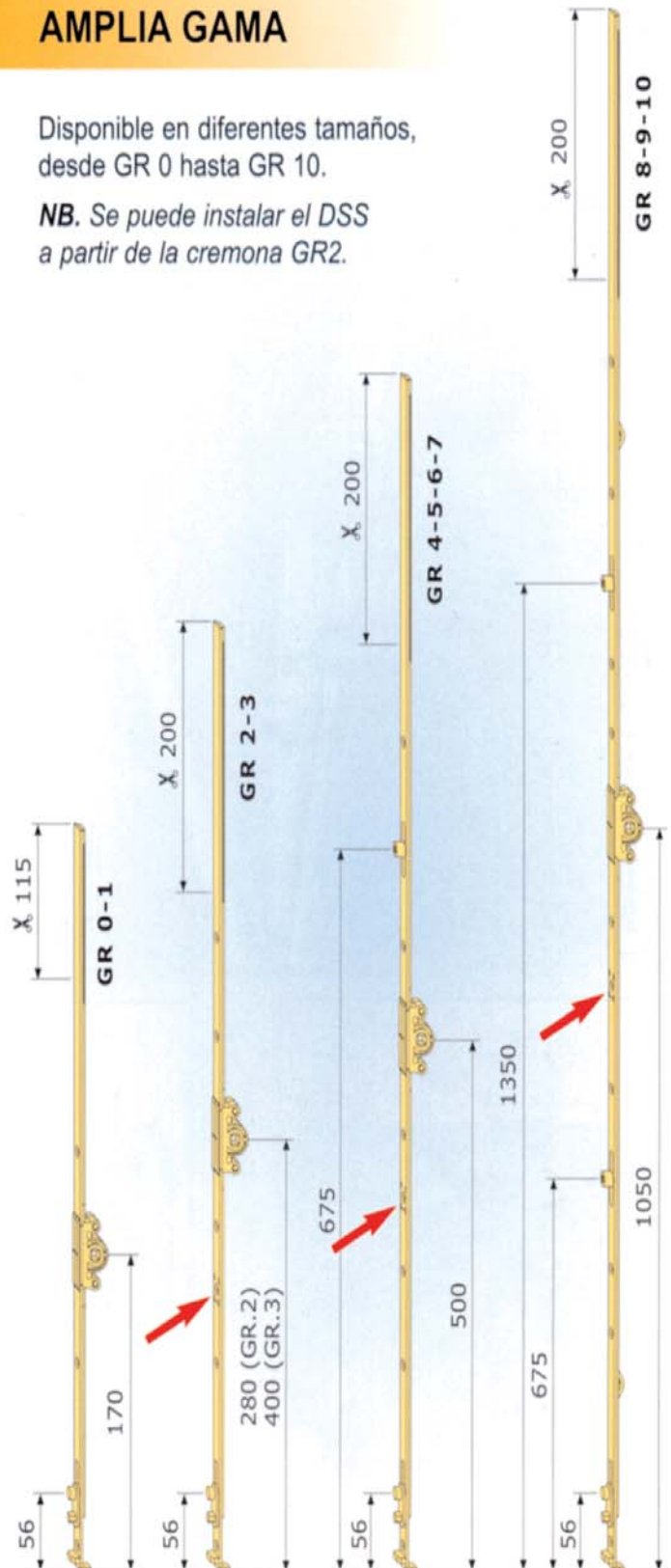

Cofres

Medidas Exteriores			Medidas Interiores			Peso (Kg)
Alt.	Larg.	Fundo	Alt.	Larg.	Fundo	
1000	600	550	750	470	380	250



910
cod. 01910

	EXTERIOR	INTERIOR
Alto	180	176
Ancho	291	278
Fondo	220	178



912
cod. 01912

	EXTERIOR	INTERIOR
Alto	400	394
Ancho	354	348
Fondo	310	260



E-911
cod. 01023

	EXTERIOR	INTERIOR
Alto	270	266
Ancho	352	348
Fondo	270	221



E-912
cod. 01024

	EXTERIOR	INTERIOR
Alto	400	394
Ancho	354	348
Fondo	310	260



E-955
cod. 01055

	EXTERIOR	INTERIOR
Alto	610	598
Ancho	380	368
Fondo	355	305



Cofres - Série 103



Mod. E-103

Mod. S-480



103
cod. 00803

	EXTERIOR	INTERIOR
Alto	252	240
Ancho	342	338
Fondo	250	210

ESPEORES	kg	mm	mm	mm
13	6	2	1	



S-103
cod. 00804

	EXTERIOR	INTERIOR
Alto	252	240
Ancho	342	338
Fondo	250	210

ESPEORES	kg	mm	mm	mm
13	6	2	1	



103-M
cod. 01001

	EXTERIOR	INTERIOR
Alto	252	240
Ancho	342	338
Fondo	250	210

ESPEORES	kg	mm	mm	mm
13	6	2	1	



E-103
cod. 01003

	EXTERIOR	INTERIOR
Alto	252	240
Ancho	342	338
Fondo	250	210

ESPEORES	kg	mm	mm	mm
13	6	2	1	



E-103-PD
cod. 01016

	EXTERIOR	INTERIOR
Alto	252	240
Ancho	342	338
Fondo	250	210

ESPEORES	kg	mm	mm	mm
13	6	2	1	



S-480
cod. 00996

	EXTERIOR	INTERIOR
Alto	480	430
Ancho	342	338
Fondo	350	310

ESPEORES	kg	mm	mm	mm
22	6	2	1	



E-480
cod. 00997

	EXTERIOR	INTERIOR
Alto	480	430
Ancho	342	338
Fondo	350	310

ESPEORES	kg	mm	mm	mm
22	6	2	1	

- Gris oscuro «grafito» (RAL 7016)
- 2 bulones de Ø 20 mm.
- Gorjas doble paletón excepto 103-M con motor y E-103-PD con pomo.
- De 4 discos (en modelos S)
- E-103, E-480 y 103-M**
Un código de uso de 2 a 15 dígitos con retardo programable de 1 a 99 minutos incorporado + código de emergencia de 8 dígitos.
- E-103-PD**
Dos códigos de usuario con programación independiente de seis dígitos fijos cada uno.
- Cerradura de emergencia de seguridad.
- Alimentación con 4 pilas AA (1,5 V).
- Toma de corriente exterior.

Cofres - Série 26











































Mod. E-5130

Mod. 2625

-  Gris oscuro «grafito» (RAL 7016)
-  2 bulones de Ø 20 mm.
-  Gorjas doble paletón.
-  De 4 discos (en modelos S)
-  • Un código de uso de 2 a 15 dígitos con retardo programable de 1 a 99 minutos incorporado + código de emergencia de 8 dígitos.
-  Cerradura de emergencia de seguridad.
-  Alimentación con 4 pilas AA (1,5 V)

Ideal para el hogar. Los modelos S-2615 y 2615 disponibles para empotrar en las paredes más estrechas de 15 cm. de espesor.

 <p>2615 cod. 00805</p> <table border="1"> <thead> <tr> <th></th> <th>EXTERIOR</th> <th>INTERIOR</th> </tr> </thead> <tbody> <tr> <td>Alto</td> <td>262</td> <td>238</td> </tr> <tr> <td>Ancho</td> <td>352</td> <td>328</td> </tr> <tr> <td>Fondo</td> <td>150</td> <td>112</td> </tr> </tbody> </table> <p>ESPEORES</p> <p>11 kg   </p>		EXTERIOR	INTERIOR	Alto	262	238	Ancho	352	328	Fondo	150	112	 <p>S-2615 cod. 00806</p> <table border="1"> <thead> <tr> <th></th> <th>EXTERIOR</th> <th>INTERIOR</th> </tr> </thead> <tbody> <tr> <td>Alto</td> <td>262</td> <td>238</td> </tr> <tr> <td>Ancho</td> <td>352</td> <td>328</td> </tr> <tr> <td>Fondo</td> <td>150</td> <td>112</td> </tr> </tbody> </table> <p>ESPEORES</p> <p>11 kg   </p>		EXTERIOR	INTERIOR	Alto	262	238	Ancho	352	328	Fondo	150	112	 <p>E-2615 cod. 01005</p> <table border="1"> <thead> <tr> <th></th> <th>EXTERIOR</th> <th>INTERIOR</th> </tr> </thead> <tbody> <tr> <td>Alto</td> <td>262</td> <td>238</td> </tr> <tr> <td>Ancho</td> <td>352</td> <td>328</td> </tr> <tr> <td>Fondo</td> <td>150</td> <td>112</td> </tr> </tbody> </table> <p>ESPEORES</p> <p>11 kg   </p>		EXTERIOR	INTERIOR	Alto	262	238	Ancho	352	328	Fondo	150	112	 <p>2625 cod. 00808</p> <table border="1"> <thead> <tr> <th></th> <th>EXTERIOR</th> <th>INTERIOR</th> </tr> </thead> <tbody> <tr> <td>Alto</td> <td>262</td> <td>238</td> </tr> <tr> <td>Ancho</td> <td>352</td> <td>328</td> </tr> <tr> <td>Fondo</td> <td>250</td> <td>212</td> </tr> </tbody> </table> <p>ESPEORES</p> <p>12 kg   </p>		EXTERIOR	INTERIOR	Alto	262	238	Ancho	352	328	Fondo	250	212	 <p>S-2625 cod. 00811</p> <table border="1"> <thead> <tr> <th></th> <th>EXTERIOR</th> <th>INTERIOR</th> </tr> </thead> <tbody> <tr> <td>Alto</td> <td>262</td> <td>238</td> </tr> <tr> <td>Ancho</td> <td>352</td> <td>328</td> </tr> <tr> <td>Fondo</td> <td>250</td> <td>212</td> </tr> </tbody> </table> <p>ESPEORES</p> <p>12 kg   </p>		EXTERIOR	INTERIOR	Alto	262	238	Ancho	352	328	Fondo	250	212
	EXTERIOR	INTERIOR																																																														
Alto	262	238																																																														
Ancho	352	328																																																														
Fondo	150	112																																																														
	EXTERIOR	INTERIOR																																																														
Alto	262	238																																																														
Ancho	352	328																																																														
Fondo	150	112																																																														
	EXTERIOR	INTERIOR																																																														
Alto	262	238																																																														
Ancho	352	328																																																														
Fondo	150	112																																																														
	EXTERIOR	INTERIOR																																																														
Alto	262	238																																																														
Ancho	352	328																																																														
Fondo	250	212																																																														
	EXTERIOR	INTERIOR																																																														
Alto	262	238																																																														
Ancho	352	328																																																														
Fondo	250	212																																																														
 <p>E-2625 cod. 01010</p> <table border="1"> <thead> <tr> <th></th> <th>EXTERIOR</th> <th>INTERIOR</th> </tr> </thead> <tbody> <tr> <td>Alto</td> <td>262</td> <td>238</td> </tr> <tr> <td>Ancho</td> <td>352</td> <td>328</td> </tr> <tr> <td>Fondo</td> <td>250</td> <td>212</td> </tr> </tbody> </table> <p>ESPEORES</p> <p>12 kg   </p>		EXTERIOR	INTERIOR	Alto	262	238	Ancho	352	328	Fondo	250	212	 <p>S-3730 cod. 00994</p> <table border="1"> <thead> <tr> <th></th> <th>EXTERIOR</th> <th>INTERIOR</th> </tr> </thead> <tbody> <tr> <td>Alto</td> <td>372</td> <td>292</td> </tr> <tr> <td>Ancho</td> <td>510</td> <td>464</td> </tr> <tr> <td>Fondo</td> <td>300</td> <td>260</td> </tr> </tbody> </table> <p>ESPEORES</p> <p>22 kg   </p>		EXTERIOR	INTERIOR	Alto	372	292	Ancho	510	464	Fondo	300	260	 <p>E-3730 cod. 00991</p> <table border="1"> <thead> <tr> <th></th> <th>EXTERIOR</th> <th>INTERIOR</th> </tr> </thead> <tbody> <tr> <td>Alto</td> <td>372</td> <td>292</td> </tr> <tr> <td>Ancho</td> <td>510</td> <td>464</td> </tr> <tr> <td>Fondo</td> <td>300</td> <td>260</td> </tr> </tbody> </table> <p>ESPEORES</p> <p>22 kg   </p>		EXTERIOR	INTERIOR	Alto	372	292	Ancho	510	464	Fondo	300	260	 <p>S-5130 cod. 00990</p> <table border="1"> <thead> <tr> <th></th> <th>EXTERIOR</th> <th>INTERIOR</th> </tr> </thead> <tbody> <tr> <td>Alto</td> <td>510</td> <td>430</td> </tr> <tr> <td>Ancho</td> <td>372</td> <td>326</td> </tr> <tr> <td>Fondo</td> <td>300</td> <td>260</td> </tr> </tbody> </table> <p>ESPEORES</p> <p>22 kg   </p>		EXTERIOR	INTERIOR	Alto	510	430	Ancho	372	326	Fondo	300	260	 <p>E-5130 cod. 00989</p> <table border="1"> <thead> <tr> <th></th> <th>EXTERIOR</th> <th>INTERIOR</th> </tr> </thead> <tbody> <tr> <td>Alto</td> <td>510</td> <td>430</td> </tr> <tr> <td>Ancho</td> <td>372</td> <td>326</td> </tr> <tr> <td>Fondo</td> <td>300</td> <td>260</td> </tr> </tbody> </table> <p>ESPEORES</p> <p>22 kg   </p>		EXTERIOR	INTERIOR	Alto	510	430	Ancho	372	326	Fondo	300	260
	EXTERIOR	INTERIOR																																																														
Alto	262	238																																																														
Ancho	352	328																																																														
Fondo	250	212																																																														
	EXTERIOR	INTERIOR																																																														
Alto	372	292																																																														
Ancho	510	464																																																														
Fondo	300	260																																																														
	EXTERIOR	INTERIOR																																																														
Alto	372	292																																																														
Ancho	510	464																																																														
Fondo	300	260																																																														
	EXTERIOR	INTERIOR																																																														
Alto	510	430																																																														
Ancho	372	326																																																														
Fondo	300	260																																																														
	EXTERIOR	INTERIOR																																																														
Alto	510	430																																																														
Ancho	372	326																																																														
Fondo	300	260																																																														

Caixas de correio

Buzones Antivandálicos

Serie 3500 _____ 36



Serie 3600 _____ 37



Serie 3700 _____ 37



Buzones Casillero Interior de Madera

Serie 2000 _____ 40



Serie 2100 _____ 41



Serie 2200 _____ 42



Serie 2300 _____ 43



Serie 2400 _____ 44



Serie 2500 _____ 45



Buzones de Exterior

Serie 905 _____ 49



Serie 906 _____ 50



Serie 908 _____ 51



Serie 910 _____ 52



Serie 1030 _____ 53



Serie 1040 _____ 54



Serie 1050 _____ 55



Serie 1060 _____ 56



Serie 1070 _____ 57



Agrupaciones Conjuntos BCP

Serie 1012 _____ 58



Serie BCP _____ 60



Bocacartas y Complementos

Serie 907 _____ 63



Serie 911 _____ 64



Series 912-913-914-915 _____ 65



Serie 904 _____ 66



Revestimiento

Melamina _____ 66



Caixas de correio

Serie 905 **Novedad**

Buzón recogecartas con doble protección al exterior: chapa galvanizada y pintura epoxi poliéster.

Preparado para bocacartas 907.

Mod. 905-1

Cuerpo y puerta en chapa de acero en color verde



Nº	CASILLERO		PUERTA	
	MATERIAL	MATERIAL	MATERIAL	MATERIAL
1	Acero	Verde carruaje	Acero	Verde carruaje
2	Acero	Negro	Acero	Negro
3	Acero	Blanco	Acero	Blanco

La puerta se abre de forma oscilante hacia arriba



Buzones

Serie 905

Dimensiones



Caixas de correio

Serie 1030

Buzón de exterior (revistero) metálico

Con tratamiento anticorrosión de cataforesis pintado en epoxi poliéster.

* Todos los modelos se suministran con bocacartas en la parte trasera.



Mod. **1030-1**

Buzón en chapa de acero pintado en color verde



Mod. **1030-2**

Buzón en chapa de acero pintado en color rojo inglés



Mod. **1030-4**

Buzón en chapa de acero pintado en color blanco



Mod. **1030-3**

Buzón en chapa de acero pintado en color verde



Mod. **1030-5**

Buzón en chapa de acero
Cuerpo pintado en color negro
y puerta en acero inoxidable



Mod. **1030-6**

Buzón en chapa de acero pintado en color grafito

Buzones

Serie 1030

Dimensiones

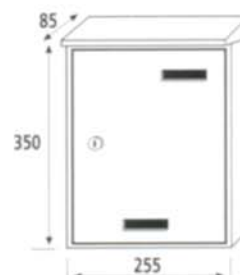

Caixas de correio

Serie 1060
**Buzón de exterior (revistero)
en material plástico (ABS)**

Mod. 1060-1

 Cuerpo pintado color verde,
puerta blanco.

Mod. 1060-2

 Cuerpo pintado color negro,
puerta blanco.

Mod. 1060-3

 Cuerpo pintado color blanco,
puerta blanco.

Mod. 1060-4

 Cuerpo pintado color negro,
puerta negro.

Mod. 1060-5

 Cuerpo pintado color verde,
puerta verde.

Buzones
Serie 1060

Dimensiones



Lanças de Alumínio



LANÇA | REF. ML 100
MED. 260x70 F. ø16



LANÇA | REF. ML 101
MED. 193x82 F. ø16



LANÇA | REF. ML 102
MED. 144x76 P. ø16-20



LANÇA | REF. ML 103
MED. 140x46 F. ø20



LANÇA | REF. ML 103
MED. G173x61 F. ø16-20
P141x48 F. ø16



LANÇA | REF. ML 104
MED. 160x67 F. ø16



LANÇA | REF. ML 104
MED. 160x71 F. ø20



LANÇA | REF. ML 104 riscada
MED. 158x70 F. ø16



LANÇA | REF. ML 105
MED. 163x73 F. ø16-20



LANÇA | REF. ML 106
MED. 160x70 F. ø16



LANÇA | REF. ML 107
MED. 160x67 F. ø16-20



LANÇA | REF. ML 108G
MED. 190x59 F. ø16-20

Lanças de Alumínio

LANÇA | REF. ML 108P
MED. 139x55 F. ø16-20



LANÇA | REF. ML 109
MED. 165x55 F. ø16



LANÇA | REF. ML 110
MED. 151x46 F. ø16



LANÇA | REF. ML 111
MED. 138x90 F. ø16



LANÇA | REF. ML 112
MED. 120x74 F. ø16



LANÇA | REF. ML 113
MED. 111x43 F. ø16



LANÇA | REF. ML 114
MED. 124x40 F. ø16



LANÇA | REF. ML 115
MED. 222x72 F. ø16



LANÇA | REF. ML 116
MED. 107x45 F. ø16-20



LANÇA | REF. ML 117
MED. 130x49 F. ø16-20



LANÇA | REF. ML 118
MED. 113x39 F. ø16



BOLA | REF. ML 119
MED. 68x40 F. ø16

Balaústres de Alumínio

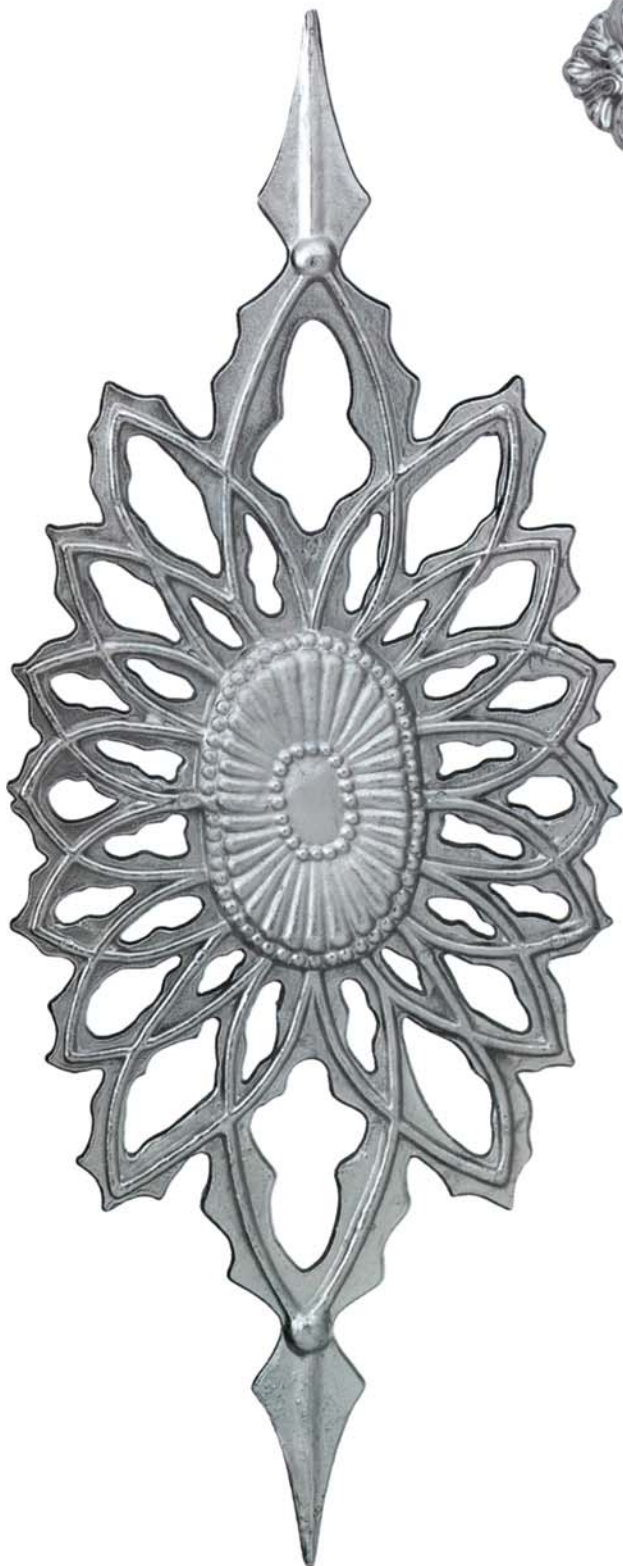

FLOR | REF. ML 575
MED. 755x295x30



FLOR | REF. ML 574
MED. 450x265x28



BALAÚSTRE | REF. ML 576
MED. 442x86 - 607x93
719x107 - 873x118



BALAÚSTRE | REF. ML 576
MED. 713x104 liso 2 faces

Balaústres de Alumínio

PINHA | REF. ML 588
MED. 152x85 P. Ø50-60-65-70-80



PIRÂMIDE | REF. ML 589
MED. 81x42 F. Ø25 F. Ø30



PIRÂMIDE | REF. ML 590
MED. 120x60 F. Ø16

BALAÚSTRE | REF. ML 591
MED. 375 - 507 - 605 - 707 - 855



BOLOTA | REF. ML 592
MED. 255x57 F. Ø16-20

BALAÚSTRE | REF. ML 587
MED. 380 - 507 - 608
705 - 810 - 867



FLOR | REF. ML 593
MED. 126x134 F. Ø16



BOLA | REF. ML 594
MED. P. Ø40-50-60-65-70-75-80-100



BASE | REF. ML 595
MED. 24x58 F. Ø20



BASE | REF. ML 595
MED. 29x46 F. Ø16

Balaústres de Alumínio



BALAÚSTRE | REF. ML 627
MED. 377x72 - 512x70 - 610x75
713x85 - 805x95 - 860x100



BALAÚSTRE | REF. ML 629
MED. 377 - 505 - 608 - 706 - 858



BALAÚSTRE | REF. ML 630
MED. 378x100 - 509x135 - 607x158
707x178 - 807x205



BALAÚSTRE | REF. ML 631
MED. 502 - 700



SAPATA | REF. ML 628
MED. 93x60x10 P/TUBO 65x30

Lanças em ferro

SET / 001
Ø 19 mm
ALT. 210 mm



SET / 002
Ø 15 mm
ALT. 140 mm



SET / 003
Ø 32 mm
ALT. 125 mm



SET / 004
Ø 20 mm
ALT. 190 mm



SET / 005
Ø 17 mm
ALT. 155 mm



SET / 006
Ø 12 mm
ALT. 130 mm



SET / 007
Ø 16 mm
ALT. 240 mm



SET / 008
Ø 40 mm
ALT. 190 mm



SET / 009
Ø 33 mm
ALT. 140 mm



SET / 010
Ø 25 mm
ALT. 125 mm



SET / 011
Ø 15 mm
ALT. 180 mm



SET / 012
Ø 13 mm
ALT. 140 mm



SET / 013
Ø 25 mm
ALT. 135 mm



SET / 014
Ø 20 mm
ALT. 120 mm



SET / 015
Ø 32 mm
ALT. 190 mm



SET / 016
Ø 30 mm
ALT. 160 mm



SET / 017
Ø 25 mm
ALT. 135 mm



SET / 018
Ø 25 mm
ALT. 125 mm

Lanças em ferro



SET / 055
Ø 20 mm
ALT. 190 mm



SET / 056
Ø 17 mm
ALT. 155 mm



SET / 057
Ø 13 mm
ALT. 125 mm



SET / 058
Ø 15 mm
ALT. 145 mm



SET / 059
Ø 16 mm
ALT. 140 mm



SET / 060
Ø 12 mm
ALT. 110 mm

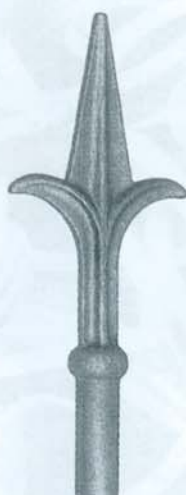

SET / 061
Ø 20 mm
ALT. 200 mm

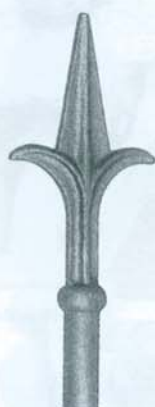

SET / 062
Ø 17 mm
ALT. 160 mm



SET / 063
Ø 13 mm
ALT. 130 mm



SET / 064
Ø 38 mm
ALT. 140 mm



SET / 065
Ø 25 mm
ALT. 125 mm



SET / 066
Ø 20 mm
ALT. 80 mm



SET / 067
Ø 26 mm
ALT. 135 mm



SET / 068
Ø 20 mm
ALT. 110 mm



SET / 069
Ø 27 mm
ALT. 110 mm



SET / 070
Ø 32 mm
ALT. 125 mm



SET / 071
Ø 33 mm
ALT. 130 mm



SET / 072
Ø 30 mm
ALT. 130 mm

Lanças em ferro

SET / 073
Ø 50 mm
ALT. 235 mm



SET / 074
Ø 25 mm
ALT. 160 mm



SET / 075
Ø 16 mm
ALT. 155 mm



SET / 076
Ø 20 mm
ALT. 130 mm

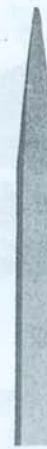

SET / 077
Ø 12 mm
Ø 16 mm
ALT. 200 mm



SET / 078
Ø 15 mm
ALT. 130 mm



SET / 079
Ø 50 mm
ALT. 170 mm



SET / 080
Ø 16 mm
ALT. 160 mm



SET / 081
Ø 40 mm
ALT. 190 mm



SET / 082
Ø 32 mm
ALT. 160 mm



SET / 083
Ø 20 mm
ALT. 125 mm



SET / 084
Ø 20 mm
ALT. 125 mm



SET / 085
Ø 12 mm
Ø 16 mm
ALT. 150 mm



SET / 086
Ø 12 mm
ALT. 70 mm



SET / 087
Ø 28 mm
ALT. 160 mm



SET / 088
Ø 20 mm
ALT. 130 mm



SET / 089
Ø 12 mm
ALT. 200 mm



SET / 090
Ø 12 mm
Ø 16 mm
ALT. 250 mm

Balaústres em ferro

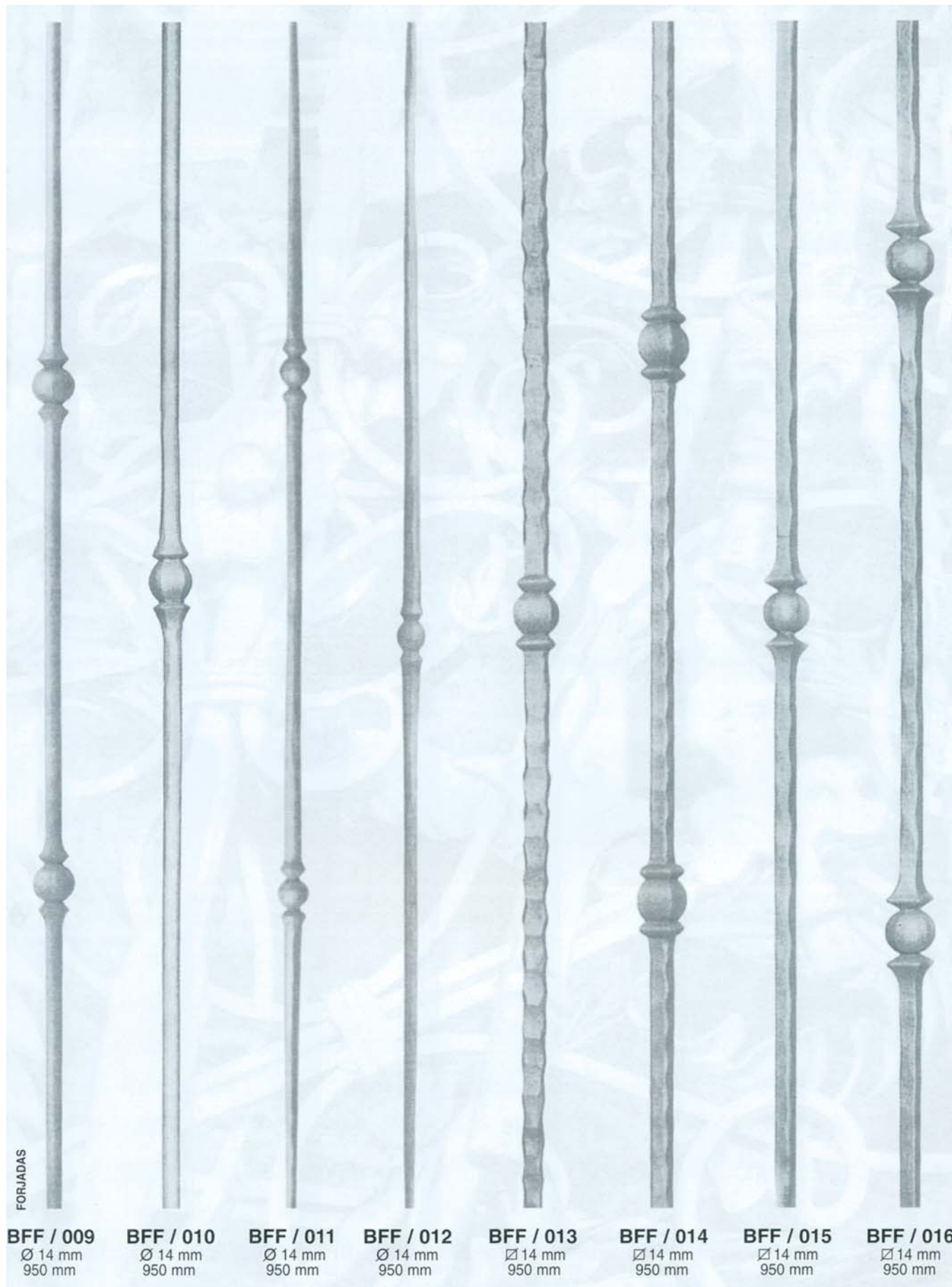

FORJADAS

BFF / 009
Ø 14 mm
950 mm

BFF / 010
Ø 14 mm
950 mm

BFF / 011
Ø 14 mm
950 mm

BFF / 012
Ø 14 mm
950 mm

BFF / 013
Ø 14 mm
950 mm

BFF / 014
Ø 14 mm
950 mm

BFF / 015
Ø 14 mm
950 mm

BFF / 016
Ø 14 mm
950 mm

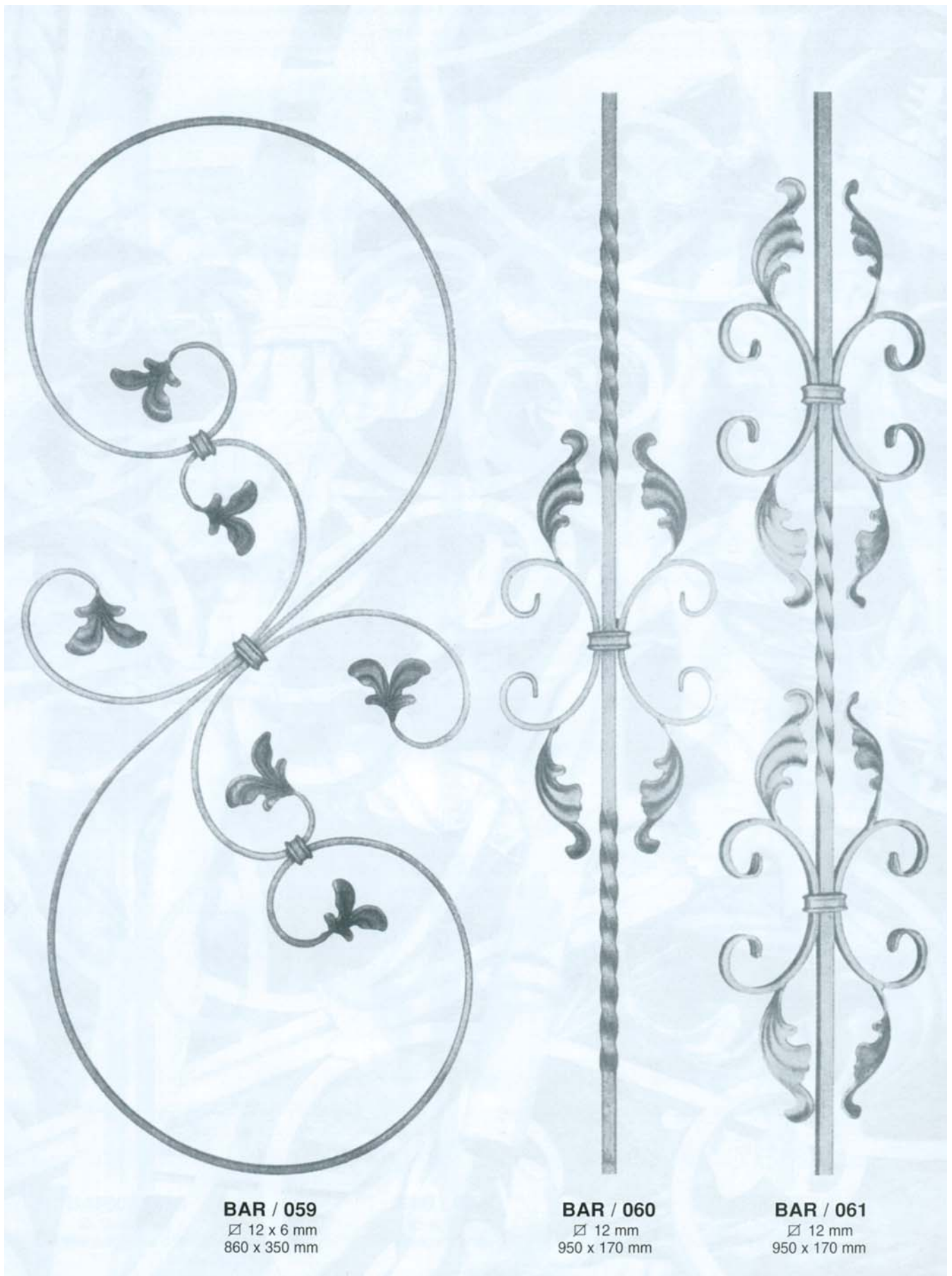
Balaústres em ferro

BAR / 059
 ∅ 12 x 6 mm
 860 x 350 mm

BAR / 060
 ∅ 12 mm
 950 x 170 mm

BAR / 061
 ∅ 12 mm
 950 x 170 mm

Selantes, Espumas e Pistolas de aplicação



SELANTES

Silicones
Acrílicos
MS polímeros
Poliuretanos



ESPUMAS DE POLIURETANO

Espuma PU manual
Espuma PU para pistola
Espuma PU Click & Fix
Espuma PU resistente ao fogo



PISTOLAS DE APLICAÇÃO

Pistolas para cartuchos
Pistolas para botijas de alumínio
Pistolas para espumas PU

Rodas

 Roda p/ portão de correr
c/ 1 rolamento

Gola V					
Ref #	ø	A	B	Carga	CX
101/50	50	17	12	200kg	25
101/60	60				20
101/80	80				20
101/100	100	20	16	300kg	12
101/120	120				10
101/140	140				6
101/160	160				

Gola U					
Ref #	ø	A	B	Carga	CX
102/50	50	17	12	200kg	25
102/60	60				20
102/80	80				20
102/100	100	20	16	300kg	12
102/120	120				10
102/140	140				6
102/160	160				

Gola LI					
Ref #	ø	A	B	Carga	CX
103/50	50	17	12	200kg	25
103/60	60				20
103/80	80				20
103/100	100	20	16	300kg	12
103/120	120				10

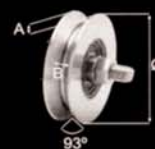
 Roda p/ portão de correr
c/ 2 rolamentos

Gola V					
Ref #	ø	A	B	Carga	CX
201/80	80	20	30	600kg	10
201/100	100				6
201/120	120				

Gola U					
Ref #	ø	A	B	Carga	CX
202/80	80	20	30	600kg	10
202/100	100				6
202/120	120				

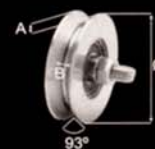

Rodas



Roda p/ portão de correr
c/ 1 rolamento canal Ø20

Ref.ª	ø	A	B	Carga	CX	Preço
252/60	60			200kg	20	4.91€
252/80	80	25	20	300kg	10	6.33€
252/100	100					8.08€

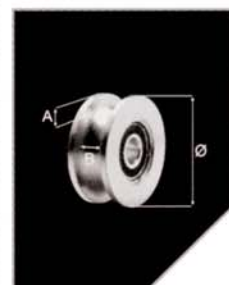

Roda p/ portão de correr
c/ suporte de soldar

Gola V						
Ref.ª	ø	A	B	Carga	CX	Preço
301/80	80			300kg	10	8.11€
301/100	100	20	16			8.15€
301/120	120					11.24€

Gola U						
Ref.ª	ø	A	B	Carga	CX	Preço
302/80	80			300kg	10	6.11€
302/100	100	20	16			8.15€
302/120	120					11.24€

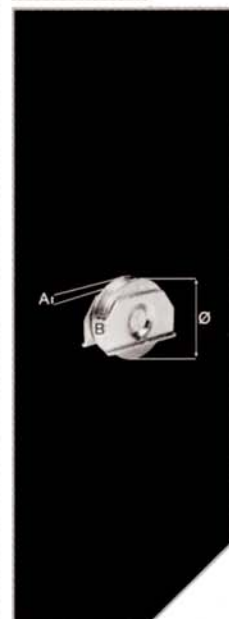

Roda p/ portão de correr
c/ suporte de 2 furos

Gola V						
Ref.ª	ø	A	B	Carga	CX	Preço
401/80	80			300kg	10	6.75€
401/100	100	20	16			8.21€
401/120	120					13.77€

Gola U						
Ref.ª	ø	A	B	Carga	CX	Preço
402/80	80			300kg	10	6.75€
402/100	100	20	16			8.21€
402/120	120					13.77€

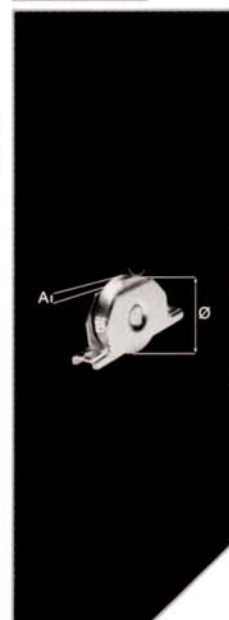

Roda p/ portão de correr
c/ suporte aparafusar

Gola V-501 / Gola U-502				
Ref.ª	ø	Carga	CX	Preço
501/502	80	300kg	10	8.15€
501/502	100	300kg	10	10.00€



Carretos

Carro N.º 10

Ref.ª	ø	R	CX
10	23	M8	100

Carro N.º 10 D

Ref.ª	ø	R	CX
10 D	23	M8	50

Carro N.º 12

Ref.ª	ø	R	CX
12	23	M8	25

Carro N.º 14

Ref.ª	ø	R	CX
14	23	M10	25

Carro N.º 35 S

Ref.ª	ø	R	CX
35 S	40	M12	25
	54	M20	10

Carro N.º 35 D

Ref.ª	ø	R	CX
35 D	40	M12	25
	54	M20	8



Folhas de madeira

COR DA FOLHA		COR DA FOLHA	
CARVALHO S/ COLA		CARVALHO C/ COLA	
LARG m/m	15 17 19 20 22 23 25 30 35 40 50 55 133	LARG m/m	16 17 19 20 22 25 30 35 40 45 50 55 85
CASTANHO S/ COLA		CASTANHO C/ COLA	
LARG m/m	15 16 19 20 22 23 25 30 35 40 45 50 55 75	LARG m/m	16 17 19 20 22 25 30 35 40 45 50
CEREJEIRA S/ COLA		CEREJEIRA C/ COLA	
LARG m/m	16 20 22 23 25 30 35 40 45	LARG m/m	15 19 20 22 23 25 35 40 45
EUCALIPTO S/ COLA		EUCALIPTO C/ COLA	
LARG m/m	20 22 25 35 40	LARG m/m	16 19 20 22 25 35 40
FAIA S/ COLA		FAIA C/ COLA	
LARG m/m	15 16 20 22 23 25 30 35 40 45 60 100	LARG m/m	16 19 20 22 25 30 35 40 50
FREIXO S/ COLA		FREIXO C/ COLA	
LARG m/m	20 25 30	LARG m/m	22 50
IZOMBÉ S/ COLA		IZOMBÉ C/ COLA	
LARG m/m		LARG m/m	19 22 25
KAMBALA S/ COLA		KAMBALA C/ COLA	
LARG m/m	15 17 18 19 20 22 23 25 30 35 40 55	LARG m/m	16 19 20 22 25 30 35 40
MOGNO S/ COLA		MOGNO C/ COLA	
LARG m/m	15 16 19 20 22 23 25 30 35 40 45 50 55 60 65 70 170	LARG m/m	14 15 16 17 19 20 22 25 30 35 40 45 50 60 70
MUTENE S/ COLA		MUTENE C/ COLA	
LARG m/m	15 18 20 22 23 25 30 35 40 45 55	LARG m/m	19 20 22 25 35 45
NOGUEIRA S/ COLA		NOGUEIRA C/ COLA	
LARG m/m		LARG m/m	22 25
PINHO S/ COLA		PINHO C/ COLA	
LARG m/m	15 16 17 19 20 22 23 25 30 35 40 45 50 60 65 140 200	LARG m/m	15 16 17 19 20 22 23 25 35 40 50 60
SUCUPIRA S/ COLA		SUCUPIRA C/ COLA	
LARG m/m	17 20 23 30	LARG m/m	22
TOLA S/ COLA		TOLA C/ COLA	
LARG m/m	15 18 20 22 23 25 30 35 40 45 55	LARG m/m	15 16 17 19 20 22 23 25 30 35 40 50
UNDIANUNO PRETO S/ COLA		UNDIANUNO PRETO C/ COLA	
LARG m/m	20 23 25 35 40	LARG m/m	19 20 22 35 40

Melaminas

COR DA MELAMINA		COR DA MELAMINA	
BRANCA S/ COLA		BRANCA C/ COLA	
LARG m/m	12 19 20 22 25 60 70	LARG m/m	14 15 16 17 19 20 22 25 35 40 45 50 60 70
CARVALHO S/ COLA		CARVALHO C/ COLA	
LARG m/m	19 20 22 25	LARG m/m	15 16 19 20 22 25 35 45 50 60
CASTANHO S/ COLA		CASTANHO C/ COLA	
LARG m/m	19	LARG m/m	15 19 22 35 50 60 70
CEREJEIRA S/ COLA		CEREJEIRA C/ COLA	
LARG m/m		LARG m/m	19 20 22 35
CINZA S/ COLA		CINZA C/ COLA	
LARG m/m		LARG m/m	19 20 25 35
CREME S/ COLA		CREME C/ COLA	
LARG m/m		LARG m/m	19 22 35
FAIA S/ COLA		FAIA C/ COLA	
LARG m/m	19 20 22	LARG m/m	19 20 22 25 32 35 40
MOGNO S/ COLA		MOGNO C/ COLA	
LARG m/m	19 20 22 40	LARG m/m	15 16 19 20 22 25 35 40 50
PINHO S/ COLA		PINHO C/ COLA	
LARG m/m		LARG m/m	19 20 22 25 35 50
PRETO LISO S/ COLA		PRETO LISO C/ COLA	
LARG m/m		LARG m/m	19 20 22 35

PVC

COR DO PVC		COR DO PVC	
BRANCA S/ COLA		BRANCA C/ COLA	
CORES LISAS S/ COLA		CORES LISAS C/ COLA	
IMITAÇÕES DE MADEIRA S/ COLA		IMITAÇÕES DE MADEIRA C/ COLA	

1987 - 2007
20 anos



Rua Dr. César Anjo | Urb. Magnólias Lt. 6 / 8 | 3510-009 Viseu - PT
T. +351 232 418 152/3 | F. +351 232 418 154
Email: geral@fcl.pt | Web: www.fcl.pt

