



# FERRAGENS

## Dobradiças para móveis TIOMOS



### A dobradiça para a porta do futuro!!

Máxima estabilidade. Amortecimento integrado. Design elegante.

O movimento da porta é regular e sem paragem. O tamanho e o peso da porta não são importantes.

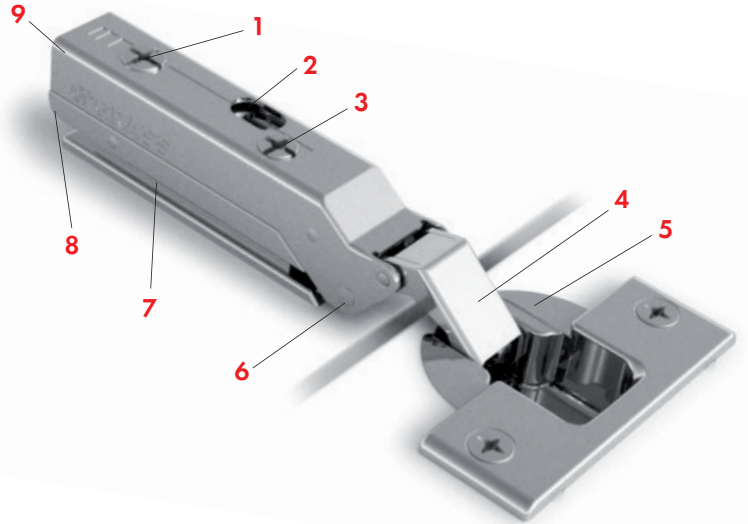

- 1. Ajuste da profundidade +3/-2 mm**  
Progressiva e de bloqueio automático através de rosca em espiral
- 2. Ajuste da altura ±2 mm**  
Ajuste através do braço da dobradiça apesar do amortecimento integrado
- 3. Ajuste do batente ±2 mm**  
Com limitação do batente
- 4. Nova cinemática**
  - Pouca força de abertura
  - Folgas mínimas
  - Um tipo de dobradiça para portas com 14-26 mm de espessura
- 5. Profundidade do copo**  
12,6 mm
- 6. Máxima qualidade e estabilidade**  
Maior durabilidade
- 7. Sistema de amortecimento integrado no braço da dobradiça**  
Invisível
- 8. Ajuste do amortecedor integrado**  
3 níveis de amortecimento à escolha
- 9. Sistema clip ergonómico**  
Montagem audível

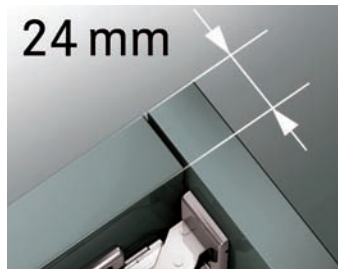

Cobertura da porta até 24 mm.

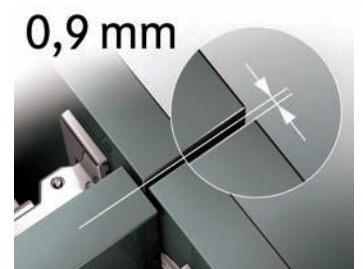

Folgas mínimas.

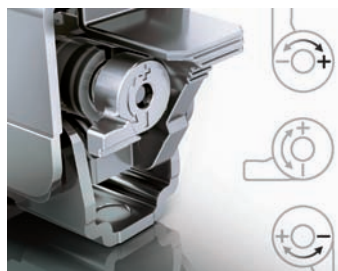

Ajuste do amortecedor sem ferramenta.



Máxima estabilidade.

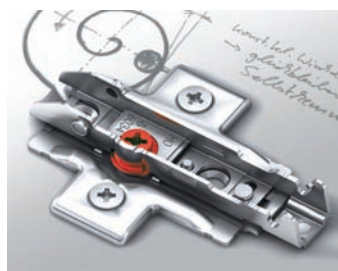

Estabilidade constante em qualquer posição.



Com ou sem amortecimento integrado.



**TIOMOS Impresso** - Montagem sem ferramenta.



**TIOMOS Click-on** - Para aparafusar.



**TIOMOS Click-on** - Para encaixar.



# FERRAGENS

## Dobradiças para móveis TIOMOS



### TIOMOS 95



**i** Ângulo de abertura 95°  
Porta até 36 mm de espessura

Art. Nr. F028 ... / F045 ... / F046 ...

### TIOMOS 110



**i** Ângulo de abertura 110°  
Porta até 24 mm de espessura

Art. Nr. F028 ... / F045 ... / F046 ...

### TIOMOS 120

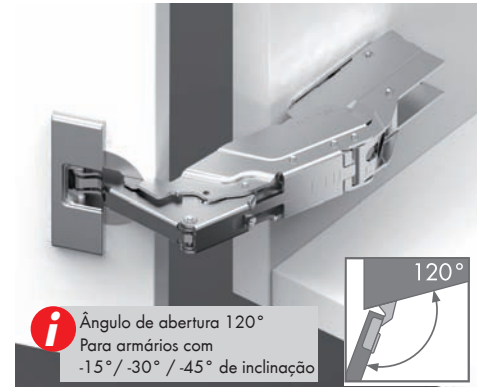

**i** Ângulo de abertura 120°  
Para armários com  
-15° / -30° / -45° de inclinação

Art. Nr. F028 ... / F045 ...

### TIOMOS 160

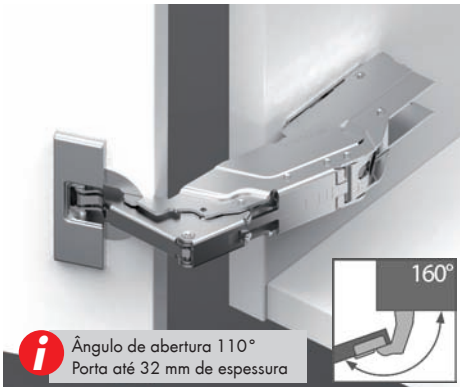

**i** Ângulo de abertura 110°  
Porta até 32 mm de espessura

Art. Nr. F028 ... / F045 ... / F046 ...

### Calços TIOMOS Art. Nr. F058 139 ...



Cunha para Calço +5°  
Art. Nr. F072 135 757

Cunha para Calço -5°  
Art. Nr. F072 135 758

## Dobradiças para móveis SOFTLINE

Art. Nr. 0683 138 ...

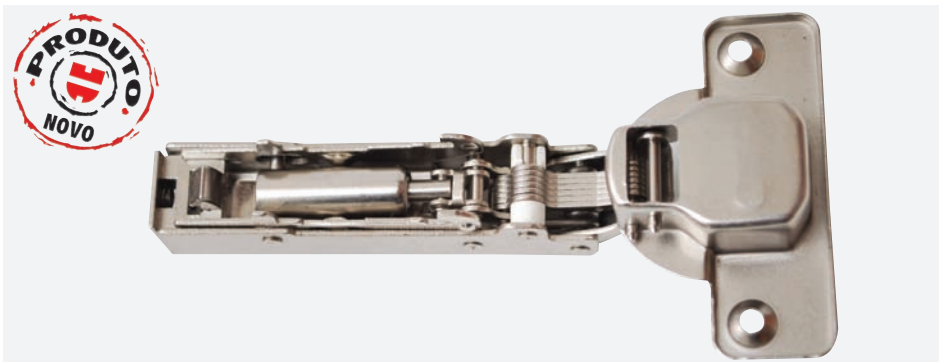

Recta

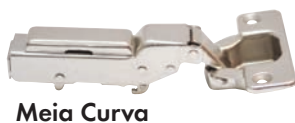

Meia Curva



Curva



Calço de regulação excêntrica  
para dobradiça SOFTLINE  
Art. Nr. 0683 138 9..



- Ângulo de abertura 100°.
- Fabricado em aço níquelado.
- Espessura máxima de porta: 2mm
- Distância de furo(TA): 3 a 7mm.
- Regulação 3D (Altura, Largura e Profundidade)
- Montagem automática ao calço (CLIP).
- Dobradiça homologada para 80.000 ciclos.
- Diâmetro do copo: 35mm.

#### • Diferentes versões:

Aparafusar dist. 48mm.

Taco Ø8 dist. 45mm.

Taco Ø10 dist. 48mm.

Taco Ø10 dist. 52mm.





# FERRAGENS

## Dobradiças para móveis NEXIS



Dobradiça NEXIS Click-on - Ângulo de 95°  
**Art. Nr. F015 072 ...**

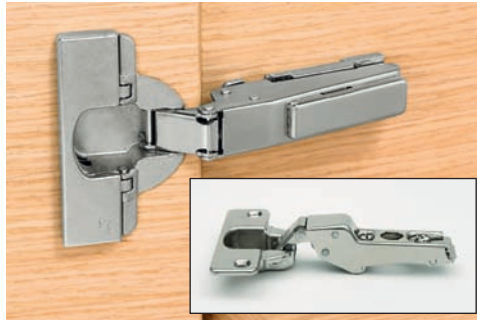

Dobradiça NEXIS Click-on - Ângulo de 100°  
**Art. Nr. F015 072 ...**

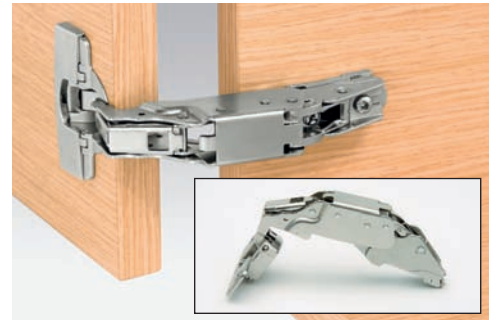

Dobradiça NEXIS Click-on - Ângulo de 170°  
**Art. Nr. F015 072 ...**



**i**  
Para armários com uma inclinação de 10°

Dobradiça NEXIS Click-on - Ângulo de 94°  
**Art. Nr. F015 072 678**



**i**  
Para armários com uma inclinação de 15°

Dobradiça NEXIS Click-on - Ângulo de 94°  
**Art. Nr. F015 072 679**

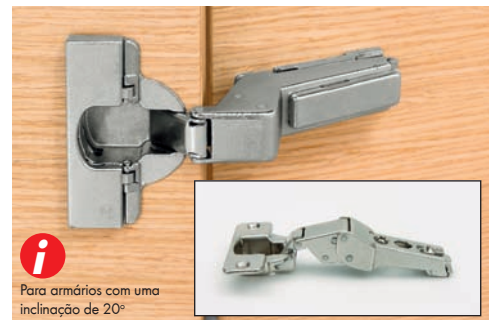

**i**  
Para armários com uma inclinação de 20°

Dobradiça NEXIS Click-on - Ângulo de 94°  
**Art. Nr. F015 072 684**



**i**  
Para armários com uma inclinação de 24°

Dobradiça NEXIS Click-on - Ângulo de 94°  
**Art. Nr. F015 072 685**

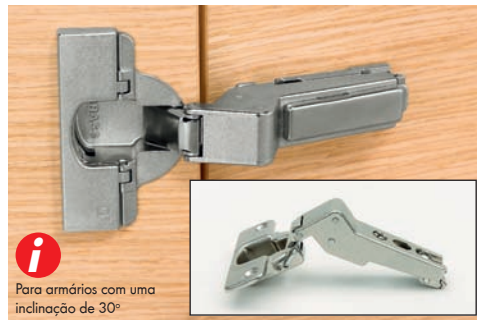

**i**  
Para armários com uma inclinação de 30°

Dobradiça NEXIS Click-on - Ângulo de 94°  
**Art. Nr. F015 072 6..**



**i**  
Para armários com uma inclinação de 37°

Dobradiça NEXIS Click-on - Ângulo de 94°  
**Art. Nr. F015 072 687**

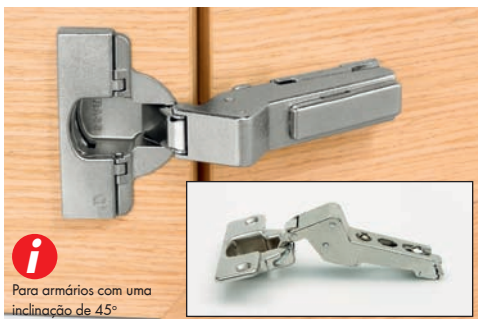

**i**  
Para armários com uma inclinação de 45°

Dobradiça NEXIS Click-on - Ângulo de 94°  
**Art. Nr. F015 072 67.**



**i**  
Para canto falso, comprida

Dobradiça NEXIS Click-on - Ângulo de 95°  
**Art. Nr. F015 072 688**  
Portas direitas e largas



**i**  
Para armários de canto

Dobradiça NEXIS Click-on - Ângulo de 95°  
**Art. Nr. F015 072 714**  
Portas bi-partidas

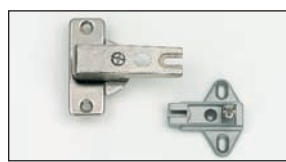

Dobradiça NEXIS Slide-on  
Ângulo de 95°  
**Art. Nr. F016 072 994**  
Móveis com laterais estreitas

**i** Para canto falso, curta



# FERRAGENS

## Dobradiças para móveis NEXIS



**i**  
Para armários com uma inclinação de -14° até -20°

Dobradiça NEXIS Click-on - Ângulo de 125°  
**Art. Nr. F015 072 705**



**i**  
Para armários com uma inclinação de -24° até -30°

Dobradiça NEXIS Click-on - Ângulo de 125°  
**Art. Nr. F015 072 702**



**i**  
Para armários com uma inclinação de -45° até -50°

Dobradiça NEXIS Click-on - Ângulo de 125°  
**Art. Nr. F015 072 706**



**i**  
Para portas de vidro ou espelho

Dobradiça NEXIS Mirro - Ângulo de 128°  
**Art. Nr. F015 072 86.**

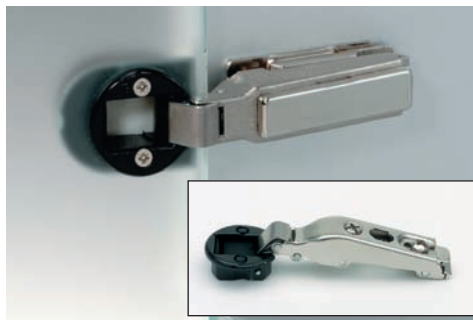

Dobradiça NEXIS Click-on para portas de vidro  
Ângulo de 94°  
**Art. Nr. F015 072 80.**



Dobradiça NEXIS Click-on para perfis de alumínio  
Ângulo de 95°  
**Art. Nr. F015 072 ...**



**TIPMATIC**  
Dobradiças NEXIS Click-on  
100° / 110° / 170° sem sistema automático



Tipmatic  
**Art. Nr. F069 073 75.**  
Conjunto Tipmatic para batente  
**Art. Nr. F069 135 02.**

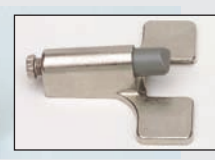

Amortecedor Soft-close para dobradiças NEXIS Click-on  
**Art. Nr. F069 073 715**



Amortecedor Soft-close para dobradiças NEXIS Click-on 170°  
**Art. Nr. F069 073 712**



Amortecedor Soft-close para portas HAR  
**Art. Nr. F069 073 706**



Illuxo - Sistema de iluminação para dobradiças  
**Art. Nr. F069 073 739 (luz azul)**  
**Art. Nr. F069 073 740 (luz branca)**



Calços para dobradiças NEXIS  
**Art. Nr. F060 073 1..**



Calços prumo para dobradiças NEXIS  
**Art. Nr. F061 073 27.**

Calços deslizante para dobradiças NEXIS  
**Art. Nr. F060 073 1..**





# FERRAGENS

## Outras dobradiças

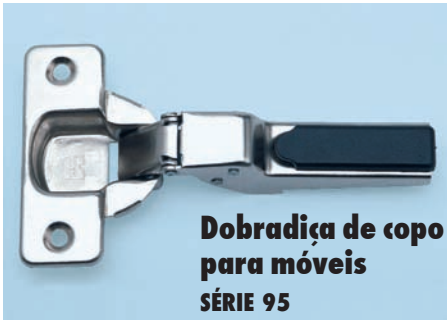

**Dobradiça de copo para móveis SÉRIE 95**

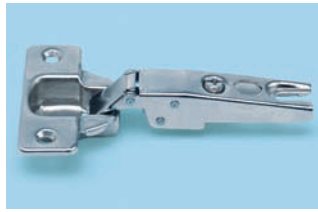

Batente à face da ilharga  
**Art. Nr. F016 072 989**  
**Art. Nr. F016 073 010**

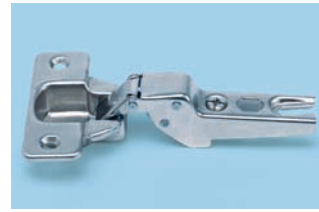

Batente a meia ilharga  
**Art. Nr. F016 072 990**  
**Art. Nr. F016 073 016**

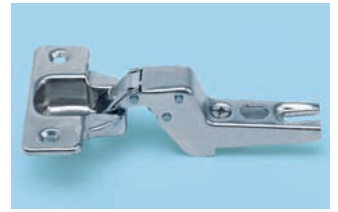

Batente no interior da ilharga  
**Art. Nr. F016 072 991**  
**Art. Nr. F016 073 020**



Calços para montagem dobradiças  
**Art. Nr. F062 073 ...**



Dobradiças de tampa  
**Art. Nr. F078 073 799**



Dobradiça em fita (tipo plano)  
**Art. Nr. 0683 12 ...**



Dobradiça para porta de vidro  
**Art. Nr. F078 073 792**



**Produto complementar**  
**Puxador de aperto**  
**Art. Nr. F069 073 457**

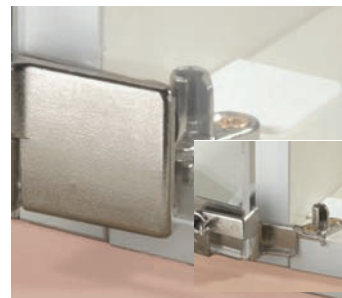

Dobradiça para porta de vidro  
**Art. Nr. F078 073 784**



Dobradiça para aplicação em prumos  
**Art. Nr. F078 073 813**



Dobradiça cilíndrica invisível  
**Art. Nr. 0683 150 30...**



# FERRAGENS

## Corrediças e Laterais de gaveta

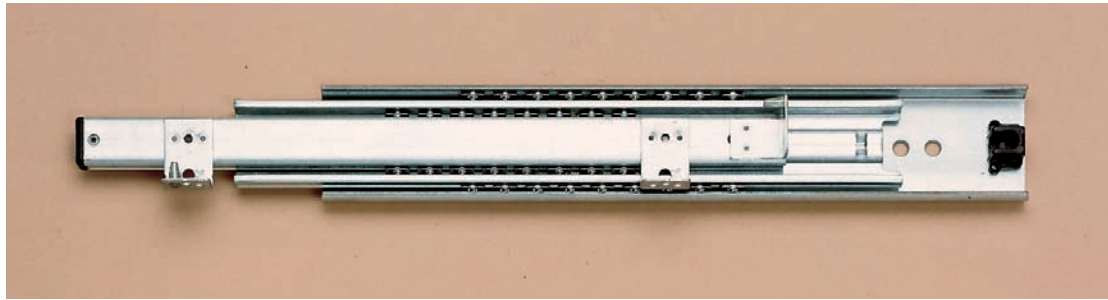

Corrediça de Esferas  
**Art. Nr. 0684 5.. ...**

**i** Capacidade de 10Kg a 70Kg



**i** Extração total sincronizada.  
Capacidade: 30Kg

Corrediça oculta Dynamoov  
Soft-close e Self-close  
**Art. Nr. F130 101 1..**



**i** Extração total sincronizada.  
Capacidade: 30Kg

Corrediça oculta Dynamoov  
Tipmatic  
**Art. Nr. F130 101 1..**



**i** Extração parcial  
Capacidade: 30Kg

Corrediça oculta Dynamic NT TA Self-close  
**Art. Nr. F089 000 0..**



Regulação em 3D



Corrediça oculta  
Dynapro Soft-close  
**Art. Nr. F130 116 0 ...**

Corrediça oculta  
Dynapro Tipmatic Plus  
**Art. Nr. F130 116 3 ...**

**i** Extração total sincronizada.  
Capacidade: 40Kg



**i**  
Capacidade: 30Kg  
Capacidade: 50Kg

Corrediça com rodízios  
Extração Parcial - **Art. Nr. F080 073 ... / 074 ...**  
Extração Total - **Art. Nr. F080 074 5..**



**i** Capacidade: 30Kg

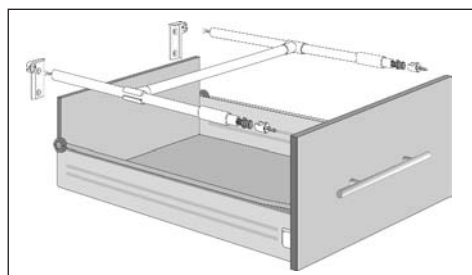

Laterais de gaveta Integra  
**Art. Nr. F084 07. ...**



Artigo complementar

Galeria para gaveta Integra  
**Art. Nr. F084 074 81 ...**





# FERRAGENS

## Corrediças e Laterais de gaveta



Cores disponíveis



Sistema de laterais de parede dupla  
**Art. Nr. F090 075 ...**

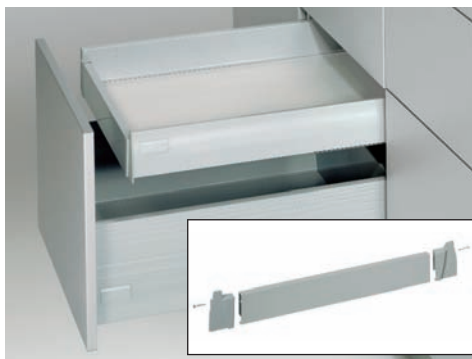

Perfil frontal DWD para gavetas interiores  
**Art. Nr. F092 083 ...**



Sistema de laterais de parede dupla  
**Art. Nr. F090 075 ...**



Galeria de aparafusar  
**Art. Nr. F092 075 8 ...**



Perfil frontal DWD para gavetas interiores c/ galeria  
**Art. Nr. F092 082 ... / 083 ...**



Sistema de fixação variável p/ traseira de gaveta  
**Art. Nr. F090 082 ...**



Dynamic-XP Soft-close  
**Art. Nr. F091 075 47 ...**

**i** Extração total. Capacidade: 40Kg



DWD-XP Tipmatic Plus  
**Art. Nr. F091 075 46 ...**

**i** Extração total. Capacidade: 40Kg



Sistema de encaixe Variowing  
**Art. Nr. F092 082 ...**



Sistema de encaixe Duowing  
**Art. Nr. F092 082 5 ...**



## FERRAGENS

### Corrediças e Laterais de gaveta

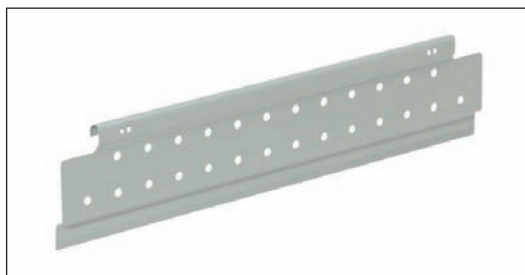

Sistema de lateral simples  
Art. Nr. F092 075 7 ...

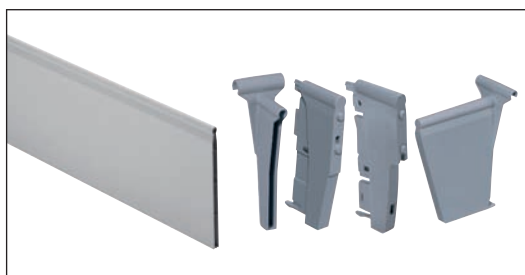

Sistema de separadores  
Optima  
Art. Nr. F092 075 8 ...



Sistema de organização  
DWD MAGIC  
Art. Nr. F092 075 6 ...

### SENSOMATIC - Sistema de Abertura Electromecânico

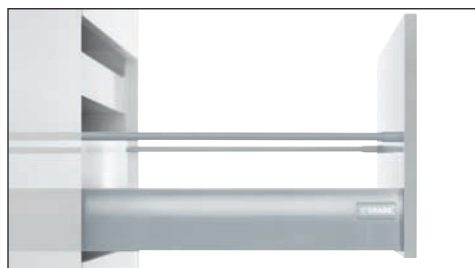

DWD-Dynamic-XP

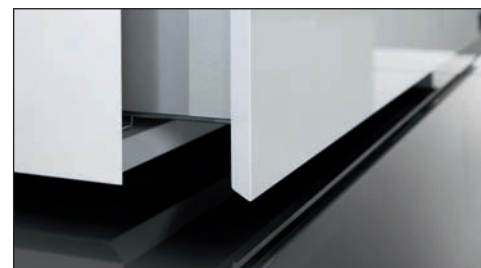

Dynapro

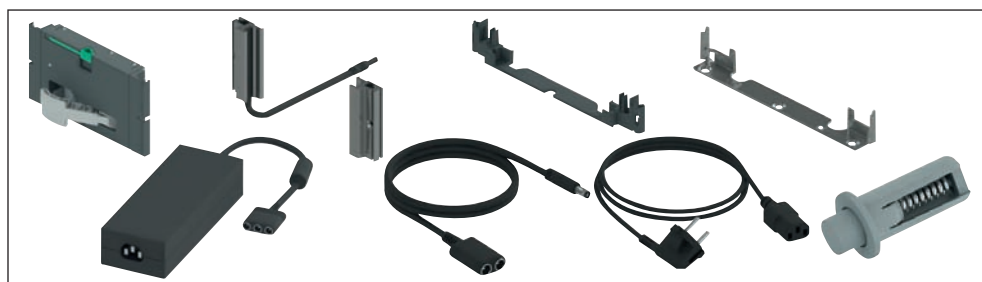
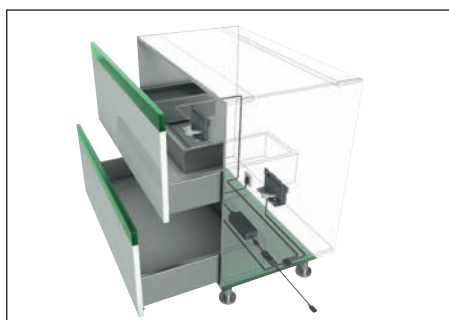

Art. Nr. F121 100 ...